

Features

- 120MHz -3dB bandwidth
- Unity-gain stable
- Low supply current
= 5.2mA at $V_S = \pm 15V$
- Wide supply range
= $\pm 2V$ to $\pm 18V$ dual-supply
= 2.5V to 36V single-supply
- High slew rate = $325V/\mu s$
- Fast settling = 80ns to 0.1% for a 10V step
- Low differential gain = 0.04% at $A_V = +2, R_L = 150\Omega$
- Low differential phase = 0.15° at $A_V = +2, R_L = 150\Omega$
- Stable with unlimited capacitive load
- Wide output voltage swing
= $\pm 13.6V$ with $V_S = \pm 15V, R_L = 1000\Omega$
= $3.8V/0.3V$ with $V_S = +5V, R_L = 500\Omega$
- Low cost, enhanced replacement for the AD847 and LM6361

Applications

- Video amplifier
- Single-supply amplifier
- Active filters/integrators
- High-speed sample-and-hold
- High-speed signal processing
- ADC/DAC buffer
- Pulse/RF amplifier
- Pin diode receiver
- Log amplifier
- Photo multiplier amplifier
- Difference amplifier

Ordering Information

Part No.	Temp. Range	Package	Outline #
EL2044CN	-40°C to +85°C	8-Pin P-DIP	MDP0031
EL2044CS	-40°C to +85°C	8-Lead SO	MDP0027

General Description

The EL2044C is a high speed, low power, low cost monolithic operational amplifier built on Elantec's proprietary complementary bipolar process. The EL2044C is unity-gain stable and features a $325V/\mu s$ slew rate and 120MHz gain-bandwidth product while requiring only 5.2 mA of supply current.

The power supply operating range of the EL2044C is from $\pm 18V$ down to as little as $\pm 2V$. For single-supply operation, the EL2044C operates from 36V down to as little as 2.5V. The excellent power supply operating range of the EL2044C makes it an obvious choice for applications on a single +5V supply.

The EL2044C also features an extremely wide output voltage swing of $\pm 13.6V$ with $V_S = \pm 15V$ and $R_L = 1000\Omega$. At $\pm 5V$, output voltage swing is a wide $\pm 3.8V$ with $R_L = 500\Omega$ and $\pm 3.2V$ with $R_L = 150\Omega$. Furthermore, for single-supply operation at +5V, output voltage swing is an excellent 0.3V to 3.8V with $R_L = 500\Omega$.

At a gain of +1, the EL2044C has a -3dB bandwidth of 120MHz with a phase margin of 50° . It can drive unlimited load capacitance, and because of its conventional voltage-feedback topology, the EL2044C allows the use of reactive or non-linear elements in its feedback network. This versatility combined with low cost and 75mA of output-current drive makes the EL2044C an ideal choice for price-sensitive applications requiring low power and high speed.

Connection Diagram

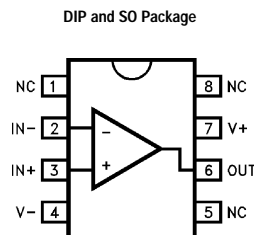

Note: All information contained in this data sheet has been carefully checked and is believed to be accurate as of the date of publication; however, this data sheet cannot be a "controlled document". Current revisions, if any, to these specifications are maintained at the factory and are available upon your request. We recommend checking the revision level before finalization of your design documentation.

EL2044C

Low Power/Low Voltage 120MHz Unity-Gain Stable Operational Amplifier

Absolute Maximum Ratings (T_A = 25°C)

Supply Voltage (V _S)	±18V or 36V	Power Dissipation (P _D)	See Curves
Peak Output Current (I _{OP})	Short-Circuit Protected	Operating Temperature Range (T _A)	-40°C to +85°C
Output Short-Circuit Duration	Infinite	Operating Junction Temperature (T _J)	150°C
(A heat-sink is required to keep junction temperature below absolute maximum when an output is shorted.)			
Input Voltage (V _{IN})	±V _S	Storage Temperature (T _{ST})	-65°C to +150°C
Differential Input Voltage (dV _{IN})	±10V		

Important Note:

All parameters having Min/Max specifications are guaranteed. Typ values are for information purposes only. Unless otherwise noted, all tests are at the specified temperature and are pulsed tests, therefore: T_J = T_C = T_A.

DC Electrical Characteristics

V_S = ±15V, R_L = 1000Ω, unless otherwise specified

Parameter	Description	Condition	Temp	Min	Typ	Max	Unit	
V _{OS}	Input Offset Voltage	V _S = ±15V	25°C		0.5	7.0	mV	
			T _{MIN} , T _{MAX}			13.0	mV	
TCV _{OS}	Average Offset	(Note 2)	All		10.0		μV/°C	
	Voltage Drift							
I _B	Input Bias Current	V _S = ±15V	25°C		2.8	8.2	μA	
			T _{MIN} , T _{MAX}			11.2	μA	
		V _S = ±5V	25°C		2.8			μA
I _{OS}	Input Offset Current	V _S = ±15V	25°C		50	300	nA	
			T _{MIN} , T _{MAX}			500	nA	
		V _S = ±5V	25°C		50			nA
TCI _{OS}	Average Offset Current Drift	[1]	All		0.3		nA/°C	
A _{VOL}	Open-Loop Gain	V _S = ±15V, V _{OUT} = ±10V, R _L = 1000Ω	25°C	800	1500		V/V	
			T _{MIN} , T _{MAX}	600			V/V	
		V _S = ±5V, V _{OUT} = ±2.5V, R _L = 500Ω	25°C		1200			V/V
			25°C		1000			V/V
PSRR	Power Supply Rejection Ratio	V _S = ±5V to ±15V	25°C	65	80		dB	
			T _{MIN} , T _{MAX}	60			dB	
CMRR	Common-Mode Rejection Ratio	V _{CM} = ±12V, V _{OUT} = 0V	25°C	70	90		dB	
			T _{MIN} , T _{MAX}	70			dB	
CMIR	Common-Mode Input Range	V _S = ±15V	25°C		±14.0		V	
		V _S = ±5V	25°C		±4.2		V	
		V _S = +5V	25°C		4.2/0.1		V	
V _{OUT}	Output Voltage Swing	V _S = ±15V, R _L = 1000Ω	25°C	±13.4	±13.6		V	
			T _{MIN} , T _{MAX}	±13.1			V	
		V _S = ±15V, R _L = 500Ω	25°C	±12.0	±13.4		V	
		V _S = ±5V, R _L = 500Ω	25°C	±3.4	±3.8		V	
		V _S = ±5V, R _L = 150Ω	25°C		±3.2		V	
		V _S = +5V, R _L = 500Ω	25°C	3.6/0.4	3.8/0.3		V	
		T _{MIN} , T _{MAX}	3.5/0.5				V	
I _{SC}	Output Short Circuit Current		25°C	40	75		mA	
			T _{MIN} , T _{MAX}	35			mA	

DC Electrical Characteristics (Continued) $V_S = \pm 15V$, $R_L = 1000\Omega$, unless otherwise specified

Parameter	Description	Condition	Temp	Min	Typ	Max	Unit
I _S	Supply Current	V _S = ±15V, No Load	25°C		5.2	7	mA
			T _{MIN} , T _{MAX}			7.6	mA
		V _S = ±5V, No Load	25°C		5.0		mA
R _{IN}	Input Resistance	Differential	25°C		150		kΩ
		Common-Mode	25°C		15		MΩ
C _{IN}	Input Capacitance	A _V = +1 @ 10MHz	25°C		1.0		pF
R _{OUT}	Output Resistance	A _V = +1	25°C		50		mΩ
PSOR	Power-Supply	Dual-Supply	25°C	±2.0		±18.0	V
	Operating Range	Single-Supply	25°C	2.5		36.0	V

1. Measured from T_{MIN} to T_{MAX}.

EL2044C**Low Power/Low Voltage 120MHz Unity-Gain Stable Operational Amplifier****Closed-Loop AC Electrical Characteristics** $V_S = \pm 15V$, $A_V = +1$, $R_L = 1000\Omega$ unless otherwise specified

Parameter	Description	Condition	Temp	Min	Typ	Max	Unit
BW	-3 dB Bandwidth ($V_{OUT} = 0.4 V_{PP}$)	$V_S = \pm 15V$, $A_V = +1$	25°C		120		MHz
		$V_S = \pm 15V$, $A_V = -1$	25°C		60		MHz
		$V_S = \pm 15V$, $A_V = +2$	25°C		60		MHz
		$V_S = \pm 15V$, $A_V = +5$	25°C		12		MHz
		$V_S = \pm 15V$, $A_V = +10$	25°C		6		MHz
		$V_S = \pm 5V$, $A_V = +1$	25°C		80		MHz
GBWP	Gain-Bandwidth Product	$V_S = \pm 15V$	25°C		60		MHz
		$V_S = \pm 5V$	25°C		45		MHz
PM	Phase Margin	$R_L = 1 k\Omega$, $C_L = 10 pF$	25°C		50		°
SR	Slew Rate ^[1]	$V_S = \pm 15V$, $R_L = 1000\Omega$	25°C	250	325		V/ μ s
		$V_S = \pm 5V$, $R_L = 500\Omega$	25°C		200		V/ μ s
FPBW	Full-Power Bandwidth ^[2]	$V_S = \pm 15V$	25°C	4.0	5.2		MHz
		$V_S = \pm 5V$	25°C		12.7		MHz
t_r , t_f	Rise Time, Fall Time	0.1V Step	25°C		3.0		ns
OS	Overshoot	0.1V Step	25°C		20		%
t_{PD}	Propagation Delay		25°C		2.5		ns
t_s	Settling to +0.1% ($A_V = +1$)	$V_S = \pm 15V$, 10V Step	25°C		80		ns
		$V_S = \pm 5V$, 5V Step			60		ns
dG	Differential Gain ^[3]	NTSC/PAL	25°C		0.04		%
dP	Differential Phase (Note 5)	NTSC/PAL	25°C		0.15		°
eN	Input Noise Voltage	10kHz	25°C		15.0		nV/ \sqrt{Hz}
iN	Input Noise Current	10kHz	25°C		1.50		pA/ \sqrt{Hz}
CI STAB	Load Capacitance Stability	$A_V = +1$	25°C		Infinite		pF

- Slew rate is measured on rising edge.
- For $V_S = \pm 15V$, $V_{OUT} = 20V_{PP}$. For $V_S = \pm 5V$, $V_{OUT} = 5V_{PP}$. Full-power bandwidth is based on slew rate measurement using: $FPBW = SR/(2\pi * V_{peak})$.
- Video Performance measured at $V_S = \pm 15V$, $A_V = +2$ with 2 times normal video level across $R_L = 150\Omega$. This corresponds to standard video levels across a back-terminated 75 Ω load. For other values of R_L , see curves.

Typical Performance Curves

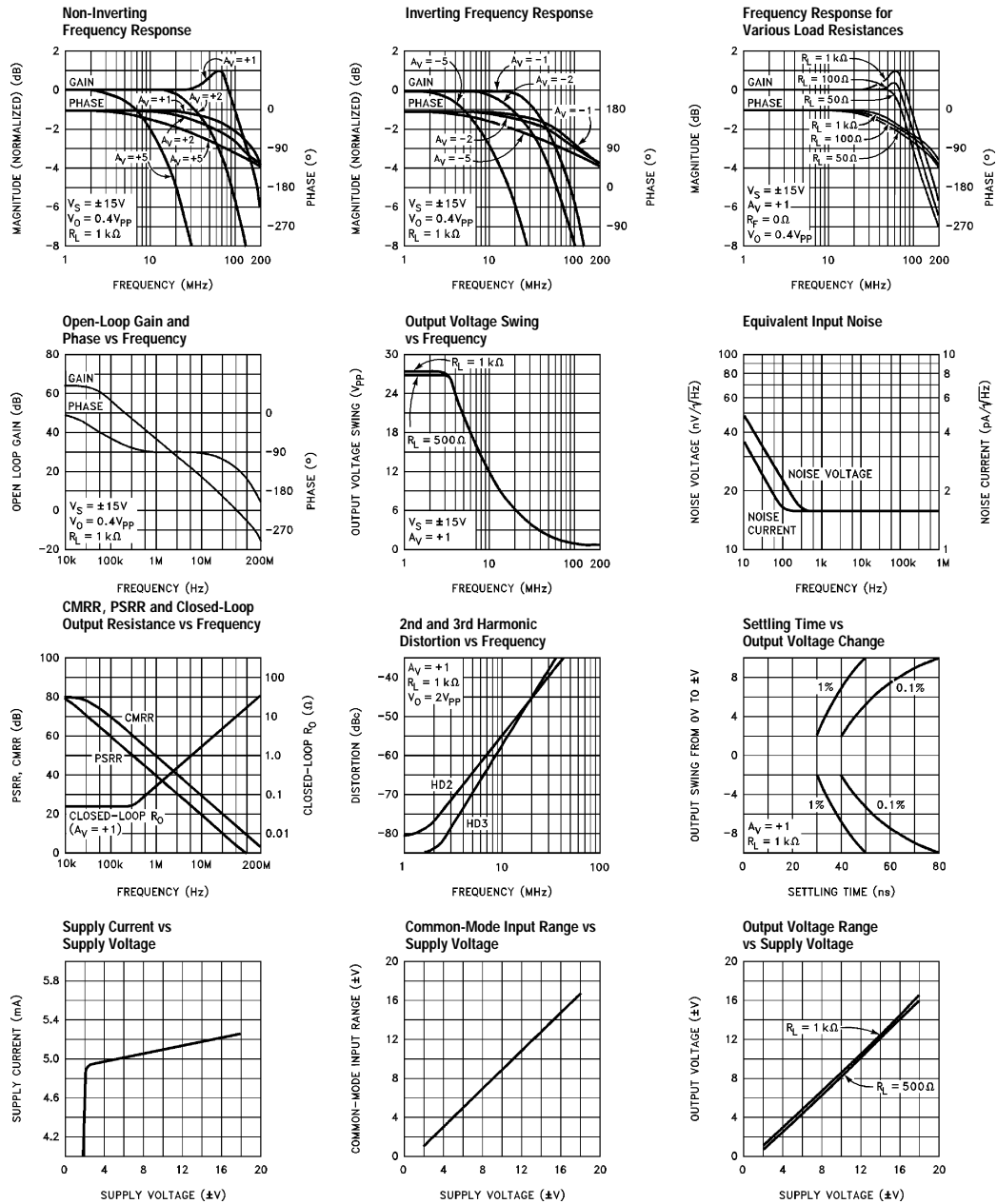

EL2044C

Low Power/Low Voltage 120MHz Unity-Gain Stable Operational Amplifier

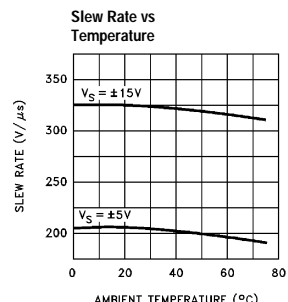
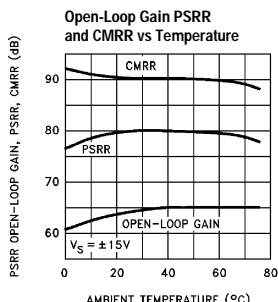
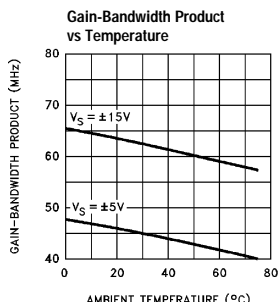
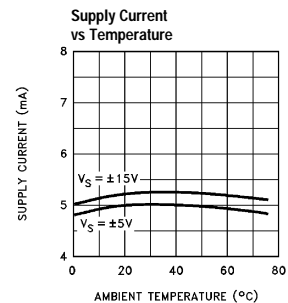
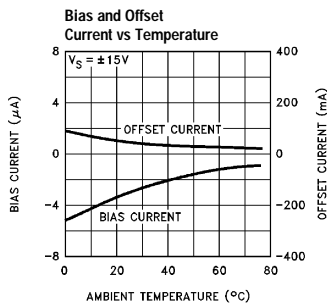
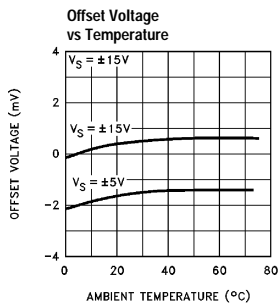
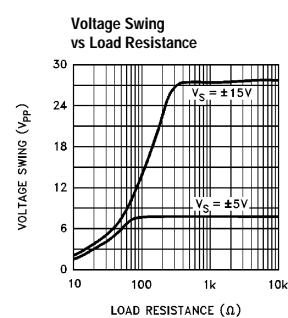
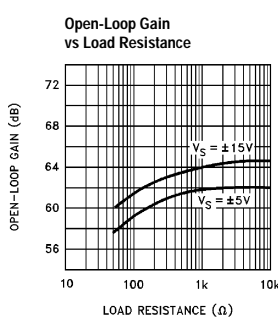
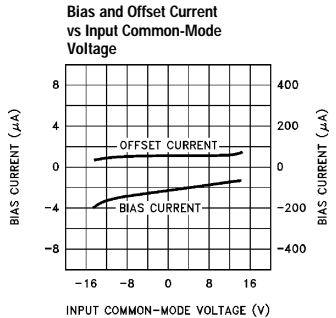
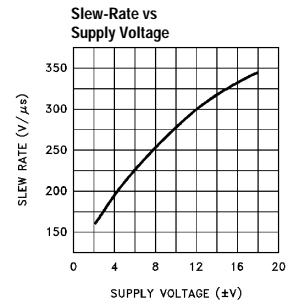
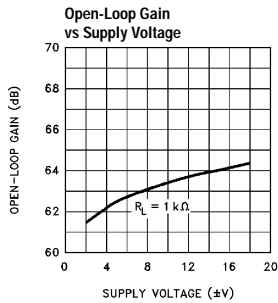
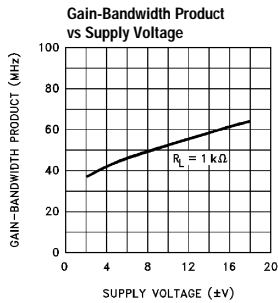

Low Power/Low Voltage 120MHz Unity-Gain Stable Operational Amplifier

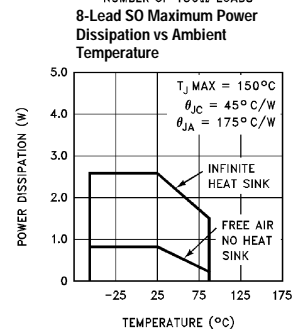
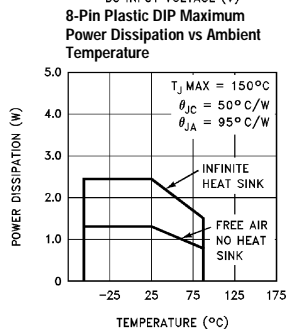
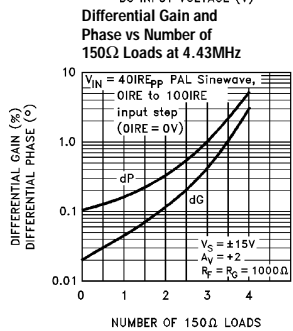
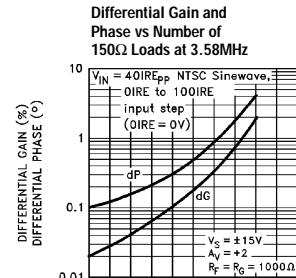
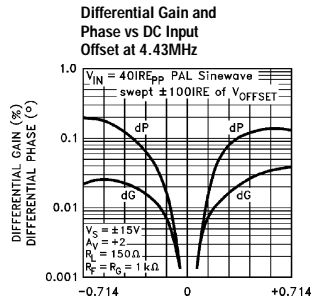
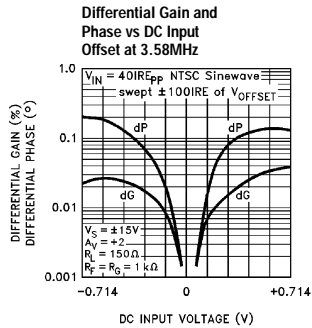
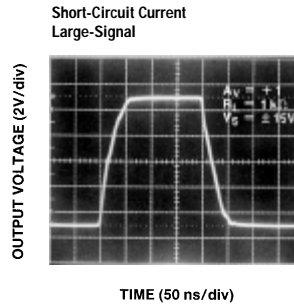
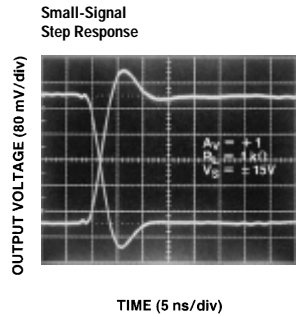
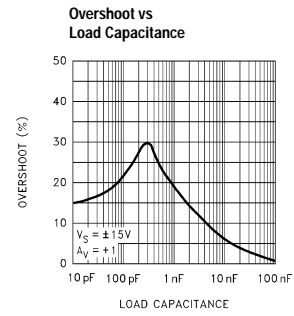
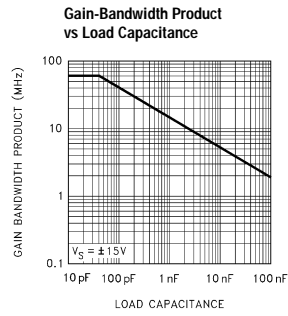
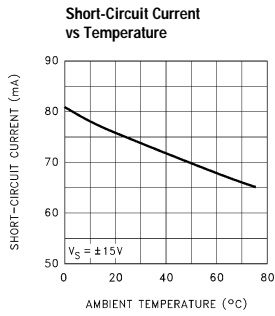

EL2044C

Low Power/Low Voltage 120MHz Unity-Gain Stable Operational Amplifier

Simplified Schematic

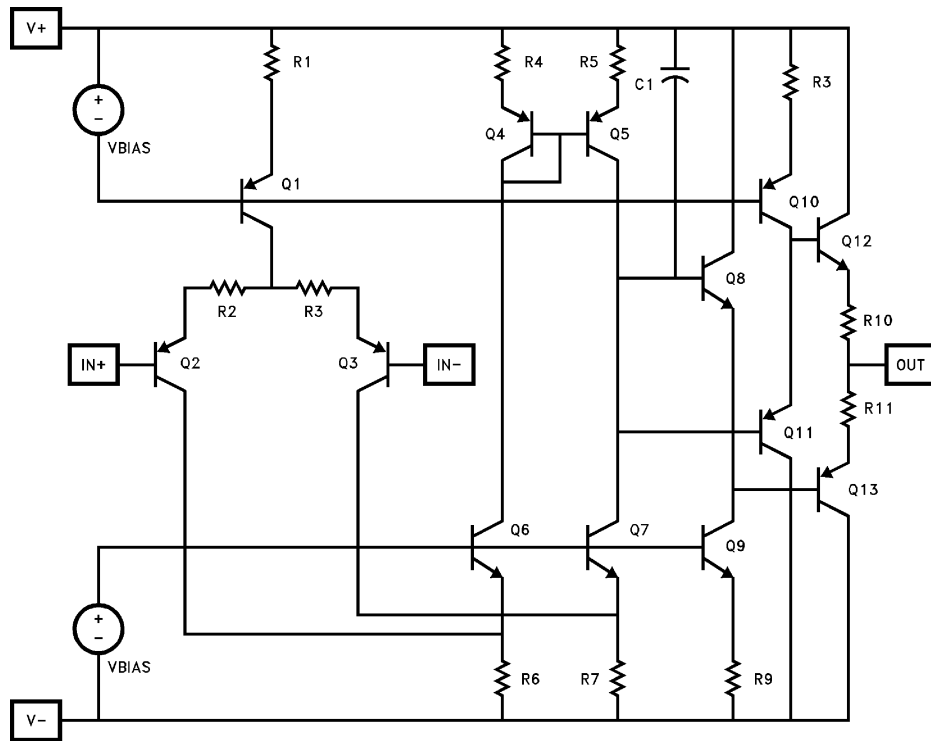

Burn-In Circuit

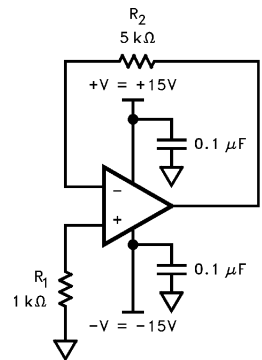

All Packages Use the Same Schematic

Applications Information

Product Description

The EL2044C is a low-power wideband monolithic operational amplifier built on Elantec's proprietary high-speed complementary bipolar process. The EL2044C uses a classical voltage-feedback topology which allows it to be used in a variety of applications where current-feedback amplifiers are not appropriate because of restrictions placed upon the feedback element used with the amplifier. The conventional topology of the EL2044C allows, for example, a capacitor to be placed in the feedback path, making it an excellent choice for applications such as active filters, sample-and-holds, or integrators. Similarly, because of the ability to use diodes in the feedback network, the EL2044C is an excellent choice for applications such as fast log amplifiers.

Single-Supply Operation

The EL2044C has been designed to have a wide input and output voltage range. This design also makes the EL2044C an excellent choice for single-supply operation. Using a single positive supply, the lower input voltage range is within 100mV of ground ($R_L = 500\Omega$), and the lower output voltage range is within 300mV of ground. Upper input voltage range reaches 4.2V, and output voltage range reaches 3.8V with a 5V supply and $R_L = 500\Omega$. This results in a 3.5V output swing on a single 5V supply. This wide output voltage range also allows single-supply operation with a supply voltage as high as 36V or as low as 2.5V. On a single 2.5V supply, the EL2044C still has 1V of output swing.

Gain-Bandwidth Product and the -3dB Bandwidth

The EL2044C has a gain-bandwidth product of 60MHz while using only 5.2mA of supply current. For gains greater than 4, its closed-loop -3dB bandwidth is approximately equal to the gain-bandwidth product divided by the noise gain of the circuit. For gains less than 4, higher-order poles in the amplifier's transfer function contribute to even higher closed loop bandwidths. For example, the EL2044C has a -3dB bandwidth of 120MHz at a gain of +1, dropping to

60MHz at a gain of +2. It is important to note that the EL2044C has been designed so that this "extra" bandwidth in low-gain applications does not come at the expense of stability. As seen in the typical performance curves, the EL2044C in a gain of +1 only exhibits 1.0dB of peaking with a 1000 Ω load.

Video Performance

An industry-standard method of measuring the video distortion of a component such as the EL2044C is to measure the amount of differential gain (dG) and differential phase (dP) that it introduces. To make these measurements, a 0.286V_{pp} (40 IRE) signal is applied to the device with 0V DC offset (0 IRE) at either 3.58MHz for NTSC or 4.43MHz for PAL. A second measurement is then made at 0.714V DC offset (100 IRE). Differential gain is a measure of the change in amplitude of the sine wave, and is measured in percent. Differential phase is a measure of the change in phase, and is measured in degrees.

For signal transmission and distribution, a back-terminated cable (75 Ω in series at the drive end, and 75 Ω to ground at the receiving end) is preferred since the impedance match at both ends will absorb any reflections. However, when double termination is used, the received signal is halved; therefore a gain of 2 configuration is typically used to compensate for the attenuation.

The EL2044C has been designed as an economical solution for applications requiring low video distortion. It has been thoroughly characterized for video performance in the topology described above, and the results have been included as typical dG and dP specifications and as typical performance curves. In a gain of +2, driving 150 Ω , with standard video test levels at the input, the EL2044C exhibits dG and dP of only 0.04% and 0.15° at NTSC and PAL. Because dG and dP can vary with different DC offsets, the video performance of the EL2044C has been characterized over the entire DC offset range from -0.714V to +0.714V. For more information, refer to the curves of dG and dP vs DC Input Offset.

EL2044C

Low Power/Low Voltage 120MHz Unity-Gain Stable Operational Amplifier

The output drive capability of the EL2044C allows it to drive up to 2 back-terminated loads with good video performance. For more demanding applications such as greater output drive or better video distortion, a number of alternatives such as the EL2120C, EL400C, or EL2073C should be considered.

Output Drive Capability

The EL2044C has been designed to drive low impedance loads. It can easily drive 6V_{pp} into a 150Ω load. This high output drive capability makes the EL2044C an ideal choice for RF, IF and video applications. Furthermore, the current drive of the EL2044C remains a minimum of 35mA at low temperatures. The EL2044C is current-limited at the output, allowing it to withstand shorts to ground. However, power dissipation with the output shorted can be in excess of the power-dissipation capabilities of the package.

Capacitive Loads

For ease of use, the EL2044C has been designed to drive any capacitive load. However, the EL2044C remains stable by automatically reducing its gain-bandwidth product as capacitive load increases. Therefore, for maximum bandwidth, capacitive loads should be reduced as much as possible or isolated via a series output resistor (R_S). Similarly, coax lines can be driven, but best AC performance is obtained when they are terminated with their characteristic impedance so that the capacitance of the coaxial cable will not add to the capacitive load seen by the amplifier. Although stable with all capacitive loads, some peaking still occurs as load capacitance increases. A series resistor at the output of the EL2044C can be used to reduce this peaking and further improve stability.

Printed-Circuit Layout

The EL2044C is well behaved, and easy to apply in most applications. However, a few simple techniques will help assure rapid, high quality results. As with any high-frequency device, good PCB layout is necessary for optimum performance. Ground-plane construction is highly recommended, as is good power supply bypassing. A 0.1μF ceramic capacitor is recommended for bypassing both supplies. Lead lengths should be as short as possible, and bypass capacitors should be as close to

the device pins as possible. For good AC performance, parasitic capacitances should be kept to a minimum at both inputs and at the output. Resistor values should be kept under 5kΩ because of the RC time constants associated with the parasitic capacitance. Metal-film and carbon resistors are both acceptable, use of wire-wound resistors is not recommended because of their parasitic inductance. Similarly, capacitors should be low-inductance for best performance.

The EL2044C Macromodel

This macromodel has been developed to assist the user in simulating the EL2044C with surrounding circuitry. It has been developed for the PSPICE simulator (copyrighted by the Microsim Corporation), and may need to be rearranged for other simulators. It approximates DC, AC, and transient response for resistive loads, but does not accurately model capacitive loading. This model is slightly more complicated than the models used for low-frequency op-amps, but it is much more accurate for AC analysis.

The model does not simulate these characteristics accurately:

noise	non-linearities
settling-time	temperature effects
CMRR PSRR	manufacturing variations

EL2044C

Low Power/Low Voltage 120MHz Unity-Gain Stable Operational Amplifier

EL2044C Macromodel

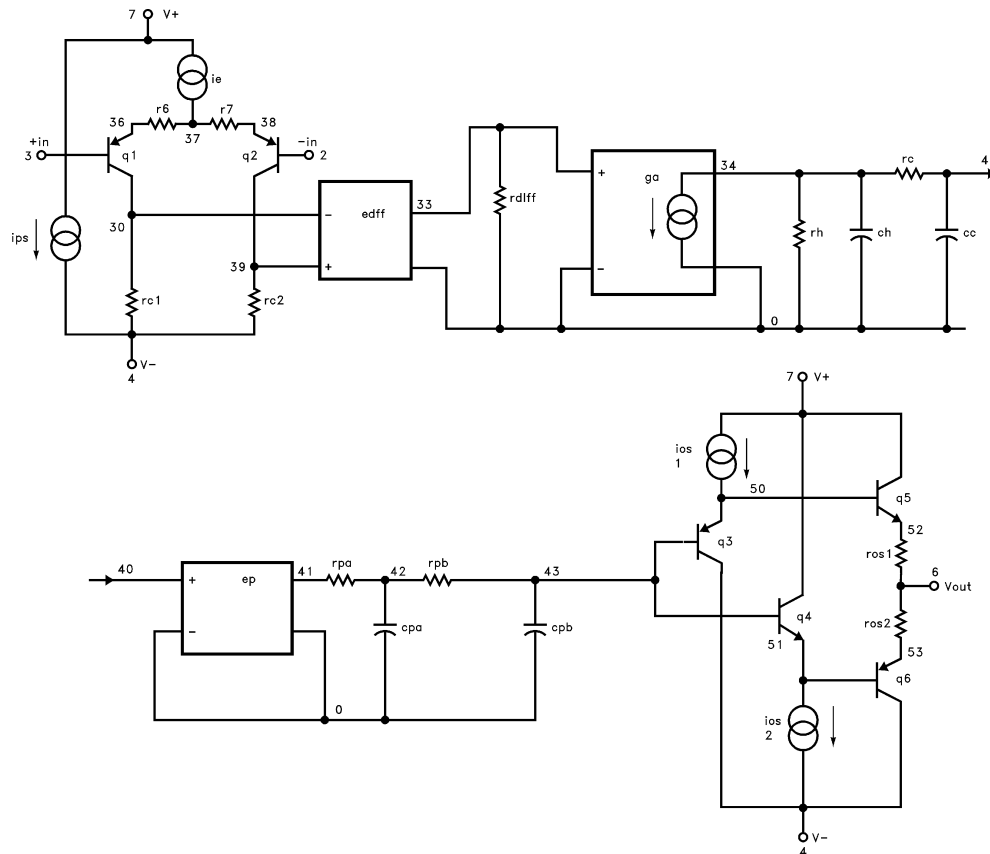

EL2044C

Low Power/Low Voltage 120MHz Unity-Gain Stable Operational Amplifier

General Disclaimer

Specifications contained in this data sheet are in effect as of the publication date shown. Elantec, Inc. reserves the right to make changes in the circuitry or specifications contained herein at any time without notice. Elantec, Inc. assumes no responsibility for the use of any circuits described herein and makes no representations that they are free from patent infringement.

élantec

HIGH PERFORMANCE ANALOG INTEGRATED CIRCUITS

Elantec Semiconductor, Inc.

675 Trade Zone Blvd.

Milpitas, CA 95035

Telephone: (408) 945-1323

(888) ELANTEC

Fax: (408) 945-9305

European Office: +44-118-977-6020

Japan Technical Center: +81-45-682-5820

WARNING - Life Support Policy

Elantec, Inc. products are not authorized for and should not be used within Life Support Systems without the specific written consent of Elantec, Inc. Life Support systems are equipment intended to support or sustain life and whose failure to perform when properly used in accordance with instructions provided can be reasonably expected to result in significant personal injury or death. Users contemplating application of Elantec, Inc. Products in Life Support Systems are requested to contact Elantec, Inc. factory headquarters to establish suitable terms & conditions for these applications. Elantec, Inc.'s warranty is limited to replacement of defective components and does not cover injury to persons or property or other consequential damages.