

LMH6504

Wideband, Low Power, Variable Gain Amplifier

General Description

The LMH™6504 is a wideband DC coupled voltage controlled gain stage followed by a high-speed current feedback Op Amp which can directly drive a low impedance load. Gain adjustment range is 80 dB for up to 10 MHz by varying the gain control input voltage, V_G .

Maximum gain is set by external components, and the gain can be reduced all the way to cut-off. Power consumption is 110 mW with a speed of 150 MHz and a gain control bandwidth (BW) of 150 MHz. Output referred DC offset voltage is less than 55 mV over the entire gain control voltage range. Device-to-device gain matching is within ± 0.42 dB at maximum gain. Furthermore, gain is tested and guaranteed over a wide range. The output current feedback Op Amp allows high frequency large signals (Slew Rate > 1500 V/ μ s) and can also drive a heavy load current (60 mA). Near ideal input characteristics (i.e. low input bias current, low offset, low pin 3 resistance) enable the device to be easily configured as an inverting amplifier as well (see Application Information section for details).

To provide ease of use when working with a single supply, V_G range is set to be from 0V to +2V relative to the ground pin potential (pin 4). V_G input impedance is high in order to ease drive requirement. In single supply operation, the ground pin is tied to a "virtual" half supply.

LMH6504 gain control is linear in dB for a large portion of the total gain control range. This makes the device suitable for AGC applications. For linear gain control applications, see LMH6503 data sheet.

The combination of minimal external components and small outline packages (SO8 and MSOP8) allows the LMH6504 to be used in space-constrained applications.

Features

$V_S = \pm 5V$, $T_A = 25^\circ C$, $R_F = 1 K\Omega$, $R_G = 100\Omega$, $R_L = 100\Omega$, $A_V = A_{VMAX} = 9.7V/V$, Typical values unless specified.

- -3 dB BW 150 MHz
- Gain control BW 150 MHz
- Adjustment range (<10 MHz) 80 dB
- Output offset voltage ± 55 mV
- Gain matching (limit) ± 0.42 dB
- Supply voltage range 7V to 12V
- Slew rate (inverting) 1500 V/ μ s
- Supply Current (no load) 11 mA
- Linear Output Current ± 60 mA
- Output Voltage Swing $\pm 2.2V$
- Input Noise Voltage 4.4 nV/ \sqrt{Hz}
- Input Noise Current 2.6 pA/ \sqrt{Hz}
- THD (20 MHz, $R_L = 100\Omega$, $V_O = 2 V_{PP}$) -45dBc
- Replacement for CLC5523

Applications

- Variable attenuator
- AGC
- Voltage controlled filter
- Video imaging processing

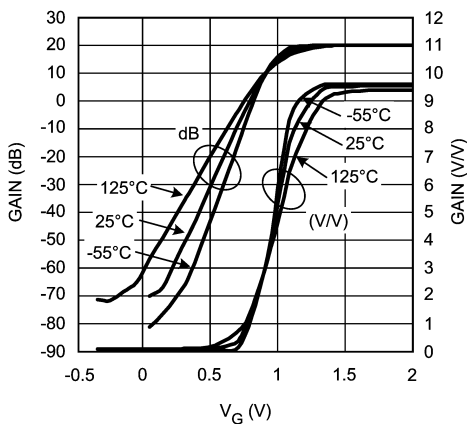

Gain vs. V_G

20084311

Typical Application

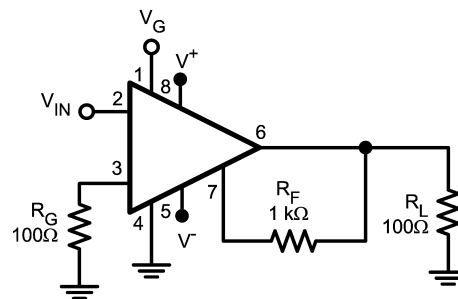

$A_{VMAX} = 9.7 V/V$

20084302

LMH™ is a trademark of National Semiconductor Corporation.

Absolute Maximum Ratings (Note 1)

If Military/Aerospace specified devices are required, please contact the National Semiconductor Sales Office/Distributors for availability and specifications.

ESD Tolerance (Note 4):

Human Body	1000V
Machine Model	100V
Input Current	±10 mA
Output Current	120 mA (Note 3)
Supply Voltages (V ⁺ - V ⁻)	12.6V
Voltage at Input/ Output pins	V ⁺ +0.8V, V ⁻ -0.8V
Storage Temperature Range	-65°C to 150°C

Junction Temperature	150°C
Soldering Information:	
Infrared or Convection (20 sec)	235°C
Wave Soldering (10 sec)	260°C

Operating Ratings (Note 1)

Supply Voltages (V ⁺ - V ⁻)	7V to 12V
Operating Temperature Range	-40°C to +85°C
Thermal Resistance:	(θ_{JC}) (θ_{JA})
8 -Pin SOIC	60 165
8-Pin MSOP	65 235

Electrical Characteristics (Note 2)

Unless otherwise specified, all limits guaranteed for T_J = 25°C, V_S = ±5V, A_{VMAX} = 9.7 V/V, R_F = 1kΩ, R_G = 100Ω, V_{IN} = ±0.1V, R_L = 100Ω, V_G = +2V. **Boldface** limits apply at the temperature extremes.

Symbol	Parameter	Conditions	Min (Note 6)	Typ (Note 6)	Max (Note 6)	Units
Frequency Domain Response						
BW	-3dB Bandwidth	V _{OUT} < 1 V _{PP}		150		MHz
		V _{OUT} < 4 V _{PP} , A _{VMAX} = 100		58		
GF	Gain Flatness	V _{OUT} < 1 V _{PP} 0.9V ≤ V _G ≤ 2V, ±0.2 dB		40		MHz
Att Range	Flat Band (Relative to Max Gain) Attenuation Range (Note 13)	±0.2 dB Flatness, f < 30 MHz		26		dB
		±0.1 dB Flatness, f < 30 MHz		9.5		
BW Control	Gain control Bandwidth	V _G = 1V (Note 12)		150		MHz
CT (dB)	Feed-through	V _G = 0V, 30 MHz (Output/Input)		-53		dB
GR	Gain Adjustment Range	f < 10 MHz		80		dB
		f < 30 MHz		73		
Time Domain Response						
t _r , t _f	Rise and Fall Time	0.5V Step		2.1		ns
OS %	Overshoot			20		%
SR	Slew Rate (Note 5)	4V Step, Non Inverting		800		V/μs
		4V Step, Inverting		1500		
Distortion & Noise Performance						
HD2	2 nd Harmonic Distortion	2V _{PP} , 20 MHz		-47		dBc
HD3	3 rd Harmonic Distortion			-55		
THD	Total Harmonic Distortion			-45		
En tot	Total Equivalent Input Noise	f > 1 MHz, R _{SOURCE} = 50Ω		4.4		nV/√Hz
I _N	Input Noise Current	f > 1 MHz		2.6		pA/√Hz
DG	Differential Gain	f = 4.43 MHz, R _L = 100Ω		0.45		%
DP	Differential Phase			0.13		deg

Electrical Characteristics(Note 2) (Continued)

Unless otherwise specified, all limits guaranteed for $T_J = 25^\circ\text{C}$, $V_S = \pm 5\text{V}$, $A_{V_{MAX}} = 9.7 \text{ V/V}$, $R_F = 1\text{k}\Omega$, $R_G = 100\Omega$, $V_{IN} = \pm 0.1\text{V}$, $R_L = 100\Omega$, $V_G = +2\text{V}$. **Boldface** limits apply at the temperature extremes.

Symbol	Parameter	Conditions	Min (Note 6)	Typ (Note 6)	Max (Note 6)	Units
DC & Miscellaneous Performance						
GACCU	Gain Accuracy (See Application Note)	$V_G = 2.0\text{V}$		0	± 0.45	dB
		$0.8\text{V} < V_G < 2\text{V}$		± 0.33	± 3.9	
G Match	Gain Matching (See Application Note)	$V_G = 2.0\text{V}$		—	± 0.42	dB
		$0.8\text{V} < V_G < 2\text{V}$		—	$+2.8/-4.2$	
K	Gain Multiplier (See Application Notes)		0.920 0.916	0.965	1.01 1.02	V/V
$V_{IN \text{ NL}}$	Input Voltage Range	R_G Open		± 3.2		V
$V_{IN \text{ L}}$		$R_G = 100\Omega$	± 0.48 ± 0.40	± 0.68		
$I_{RG \text{ MAX}}$	R_G Current	Pin 3	± 4.8 ± 4.0	± 6.8		mA
I_{BIAS}	Bias Current	Pin 2 (Note 7)		-1.4	-3.5 -3.7	μA
TC I_{BIAS}	Bias Current Drift	Pin 2 (Note 8)		-190		$\text{pA}/^\circ\text{C}$
R_{IN}	Input Resistance	Pin 2		7		$\text{M}\Omega$
C_{IN}	Input Capacitance	Pin 2		2.8		pF
I_{VG}	V_G Bias Current	Pin 1, $V_G = 2\text{V}$ (Note 7)		0.9		μA
TC I_{VG}	V_G Bias Drift	Pin 1 (Note 8)		10		$\text{pA}/^\circ\text{C}$
R_{VG}	V_G Input Resistance	Pin 1		25		$\text{M}\Omega$
C_{VG}	V_G Input Capacitance	Pin 1		2.8		pF
$V_{OUT \text{ L}}$	Output Voltage Range	$R_L = 100\Omega$	± 2.0 ± 1.7	± 2.2		V
		$R_L = \text{Open}$		± 3.1		
R_{OUT}	Output Impedance	DC		0.12		Ω
I_{OUT}	Output Current	$V_{OUT} = \pm 4\text{V}$ from Rails	± 60 ± 40	± 80		mA
$V_{O \text{ OFFSET}}$	Output Offset Voltage	$0\text{V} < V_G < 2\text{V}$		± 10	± 55 ± 70	mV
+PSRR	+Power Supply Rejection Ratio (Note 9)	Input Referred, 1V change, $V_G = 2.2\text{V}$	-65	-76		dB
-PSRR	-Power Supply Rejection Ratio (Note 9)	Input Referred, 1V change, $V_G = 2.2\text{V}$	-65	-88		dB
I_S	Supply Current	No Load	8.5 6.5	11	15 16	mA

Electrical Characteristics (Note 2) (Continued)

- Note 1:** Absolute Maximum Ratings indicate limits beyond which damage to the device may occur. Operating Ratings indicate conditions for which the device is intended to be functional, but specific performance is not guaranteed. For guaranteed specifications, see the Electrical Characteristics.
- Note 2:** Electrical Table values apply only for factory testing conditions at the temperature indicated. Factory testing conditions result in very limited self-heating of the device such that $T_J = T_A$. No guarantee of parametric performance is indicated in the electrical tables under conditions of internal self-heating where $T_J > T_A$.
- Note 3:** The maximum output current (I_{OUT}) is determined by device power dissipation limitations or value specified, whichever is lower.
- Note 4:** Human body model, 1.5 k Ω in series with 100 pF. Machine Model, 0 Ω in series with 200 pF
- Note 5:** Slew rate is the average of the rising and falling slew rates.
- Note 6:** Typical values represent the most likely parametric norm. Bold numbers refer to over temperature limits.
- Note 7:** Positive current corresponds to current flowing into the device.
- Note 8:** Drift determined by dividing the change in parameter distribution at temperature extremes by the total temperature change.
- Note 9:** +PSRR definition: $[\Delta V_{OUT} / \Delta V^+ / A_V]$, -PSRR definition: $[\Delta V_{OUT} / \Delta V^- / A_V]$ with 0.1V input voltage. ΔV_{OUT} is the change in output voltage with offset shift subtracted out.
- Note 10:** Gain/Phase normalized to low frequency value at 25°C.
- Note 11:** Gain/Phase normalized to low frequency value at each setting.
- Note 12:** Gain control frequency response schematic:

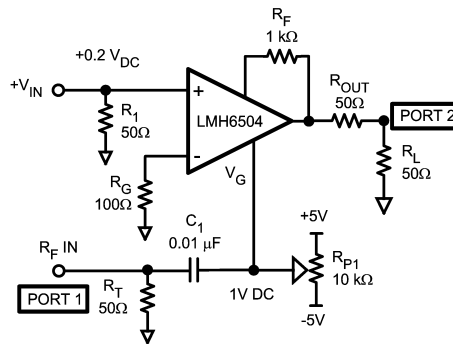

20084316

- Note 13:** Flat Band Attenuation (Relative To Max Gain) Range Definition: Specified as the attenuation range from maximum which allows gain flatness specified (either ± 0.2 dB or ± 0.1 dB), relative to A_{VMAX} gain. For example, for $f < 30$ MHz, here are the Flat Band Attenuation ranges:
 ± 0.2 dB: 19.7 dB down to -6.3 dB = 26 dB range
 ± 0.1 dB: 19.7 dB down to 10.2 dB = 9.5 dB range

Connection Diagram

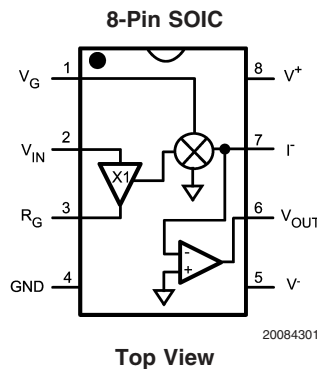

20084301

Ordering Information

Package	Part Number	Package Marking	Transport Media	NSC Drawing
8-Pin SOIC	LMH6504MA	LMH6504MA	95 Units/Rail	M08A
	LMH6504MAX		2.5k Units Tape and Reel	
8-Pin MSOP	LMH6504MM	A93A	1k Units Tape and Reel	MUA08A
	LMH6504MMX		3.5k Units Tape and Reel	

Typical Performance Characteristics Unless otherwise specified: $V_S = \pm 5V$, $T_A = 25^\circ C$, $V_G = V_{GMAX}$, $R_F = 1\text{ k}\Omega$, $R_G = 100\Omega$, $V_{IN} = 0.1V$, input terminated in 50Ω . $R_L = 100\Omega$, Typical values.

Frequency Response Over Temperature

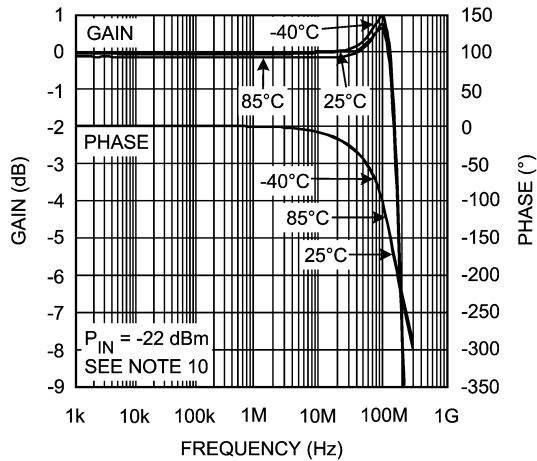

20084303

Frequency Response for Various V_G

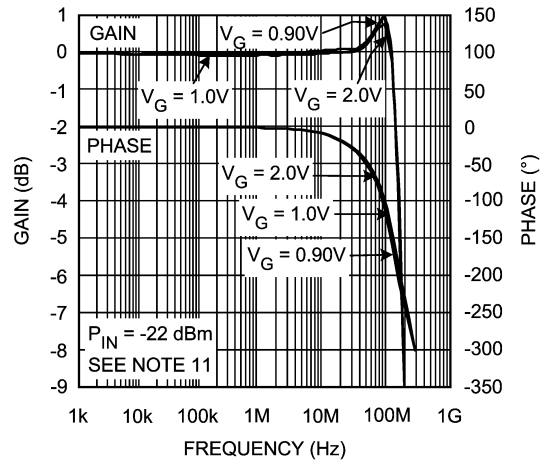

20084304

Frequency Response ($A_{VMAX} = 2$)

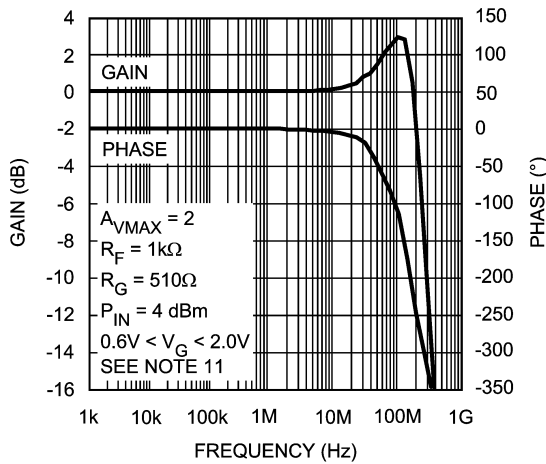

20084346

Inverting Frequency Response

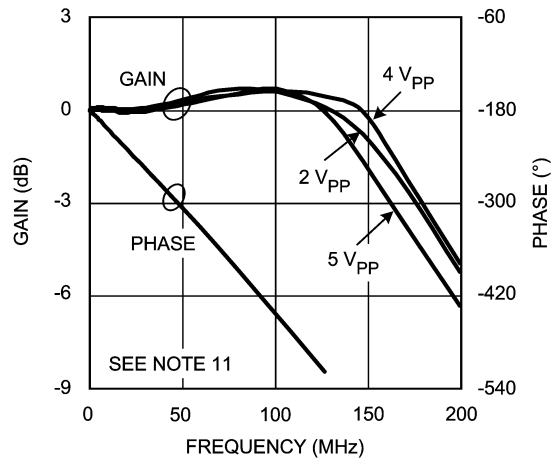

20084344

Frequency Response for Various V_G ($A_{VMAX} = 100$) (Large Signal)

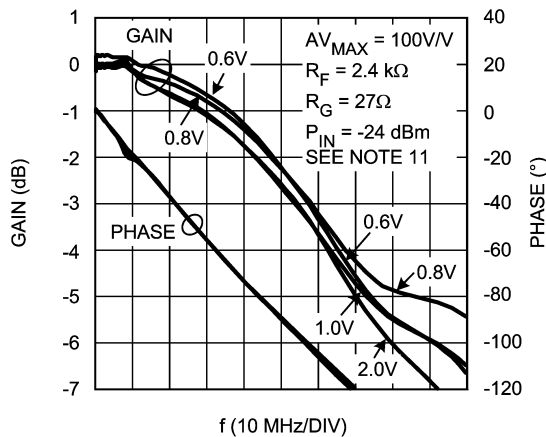

20084345

Frequency Response for Various Amplitudes

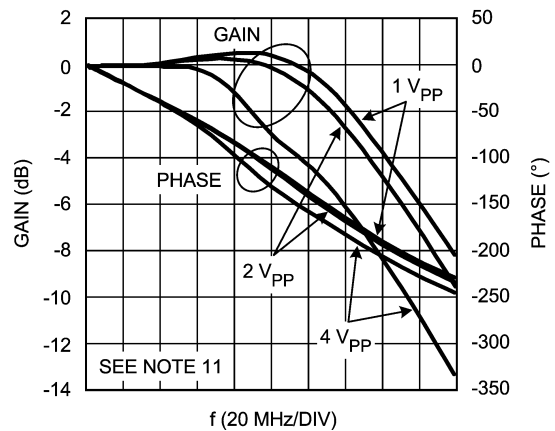

20084364

Typical Performance Characteristics Unless otherwise specified: $V_S = \pm 5V$, $T_A = 25^\circ C$, $V_G = V_{GMAX}$, $R_F = 1\text{ k}\Omega$, $R_G = 100\Omega$, $V_{IN} = 0.1V$, input terminated in 50Ω . $R_L = 100\Omega$, Typical values. (Continued)

Gain Control Frequency Response

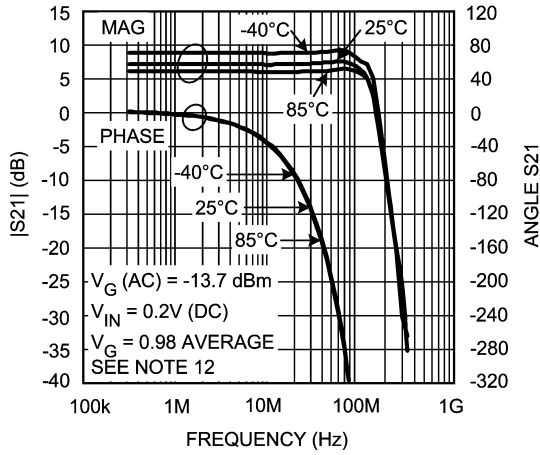

20084333

I_S vs. V_S

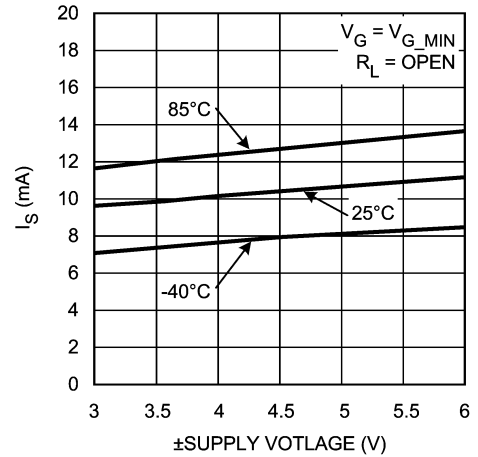

20084321

I_S vs. V_S

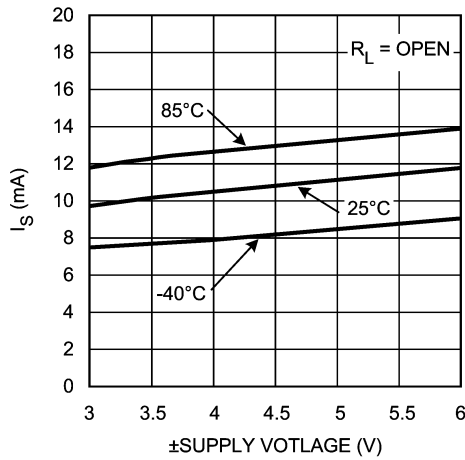

20084320

Input Bias Current vs. V_S

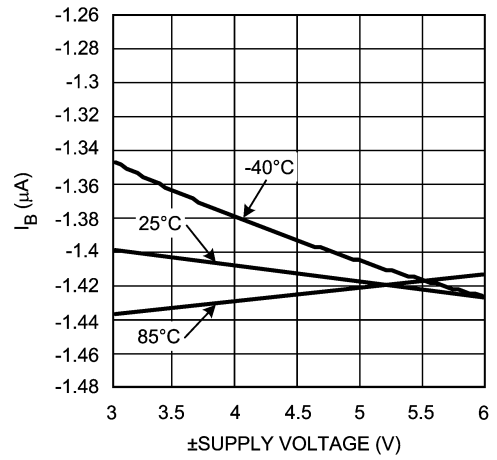

20084322

PSRR

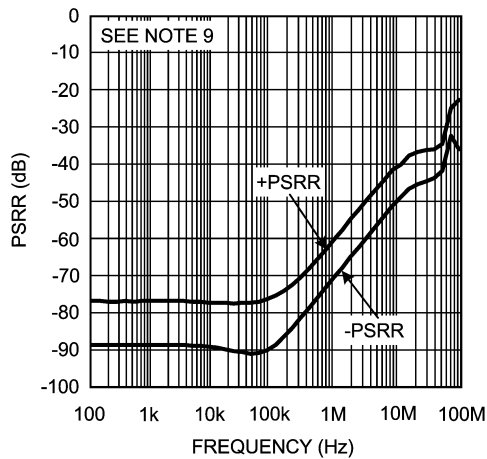

20084334

A_{VMAX} vs. Supply Voltage

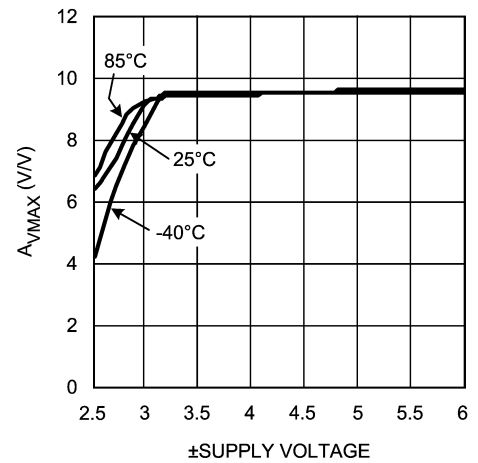

20084323

Typical Performance Characteristics

Unless otherwise specified: $V_S = \pm 5V$, $T_A = 25^\circ C$, $V_G = V_{GMAX}$, $R_F = 1\text{ k}\Omega$, $R_G = 100\Omega$, $V_{IN} = 0.1V$, input terminated in 50Ω . $R_L = 100\Omega$, Typical values. (Continued)

Feed through Isolation for Various A_{VMAX}

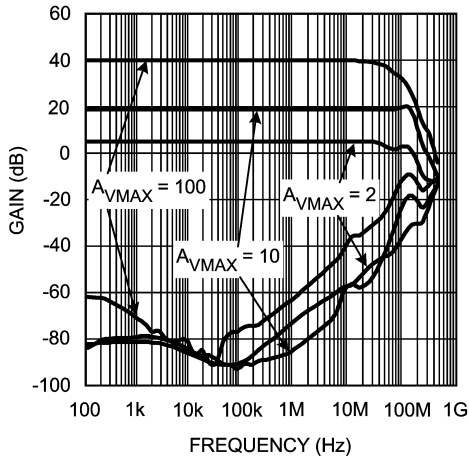

20084341

Gain Variation Over entire Temp Range vs. V_G

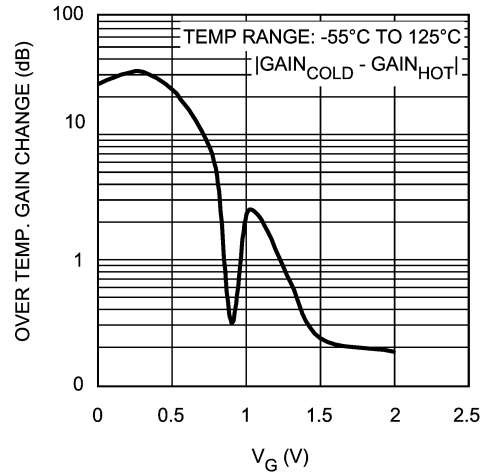

20084312

I_{RG} vs. V_{IN}

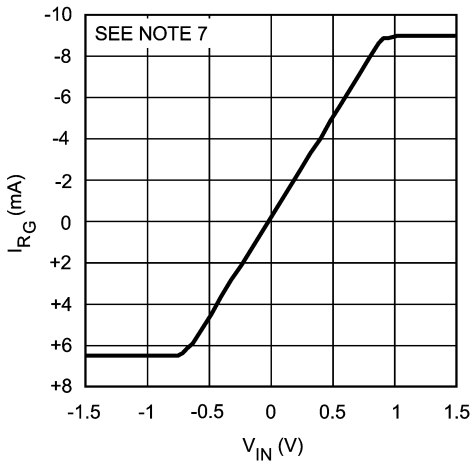

20084318

Gain vs. V_G

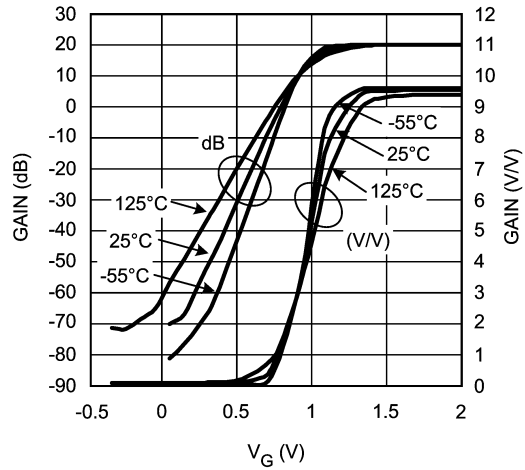

20084311

Gain vs. V_G Including Limits

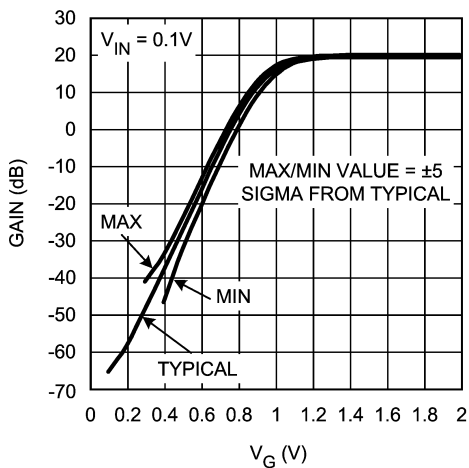

20084363

Output Offset Voltage vs. V_G (Typical Unit #1)

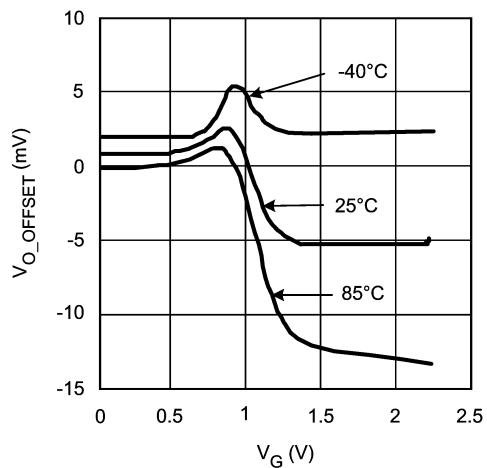

20084325

Typical Performance Characteristics Unless otherwise specified: $V_S = \pm 5V$, $T_A = 25^\circ C$, $V_G = V_{GMAX}$, $R_F = 1\text{ k}\Omega$, $R_G = 100\Omega$, $V_{IN} = 0.1V$, input terminated in 50Ω . $R_L = 100\Omega$, Typical values. (Continued)

Output Offset Voltage vs. V_G (Typical Unit #2)

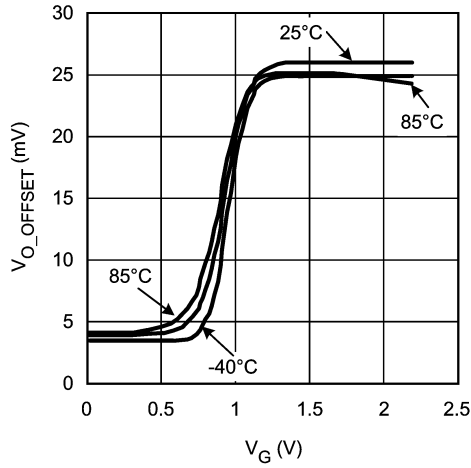

20084330

Output Offset Voltage vs. V_G (Typical Unit #3)

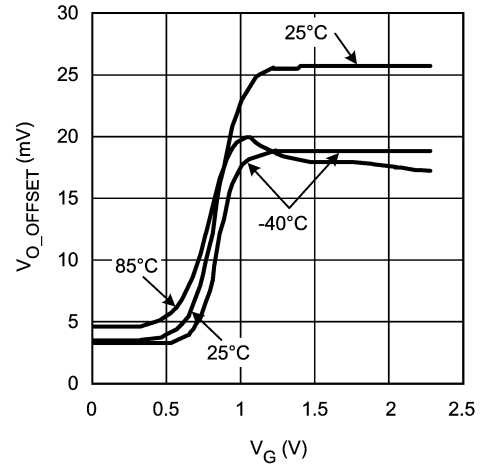

20084328

Distribution of Output Offset Voltage

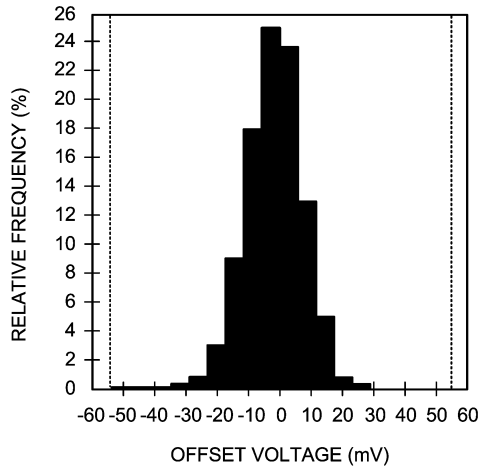

20084361

Output Noise Density vs. Frequency

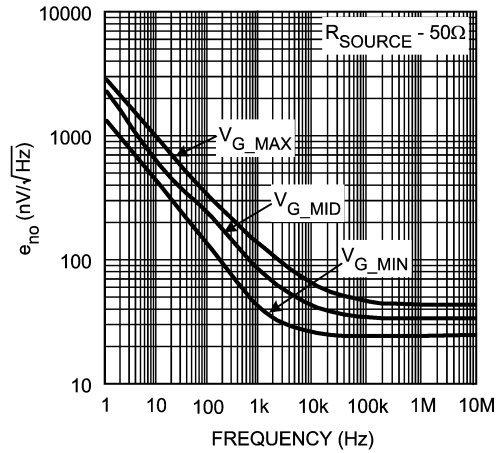

20084308

Output Noise Density vs. Frequency

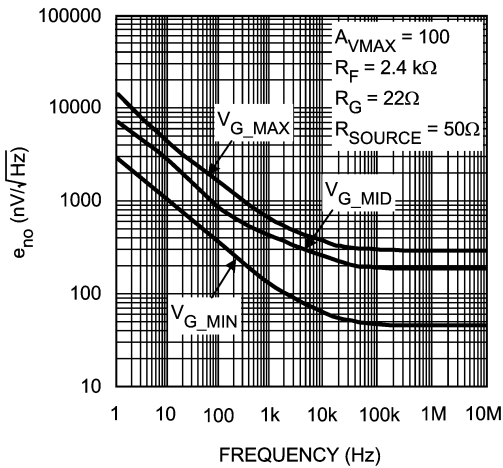

20084338

Output Noise Density vs. Frequency

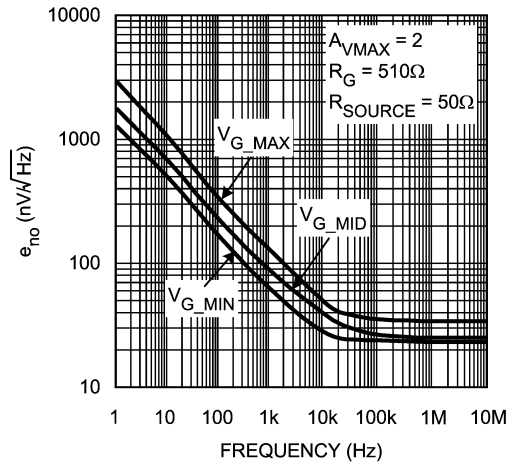

20084337

Typical Performance Characteristics

Unless otherwise specified: $V_S = \pm 5V$, $T_A = 25^\circ C$, $V_G = V_{G_MAX}$, $R_F = 1\text{ k}\Omega$, $R_G = 100\Omega$, $V_{IN} = 0.1V$, input terminated in 50Ω . $R_L = 100\Omega$, Typical values. (Continued)

Input Referred Noise Density vs. Frequency

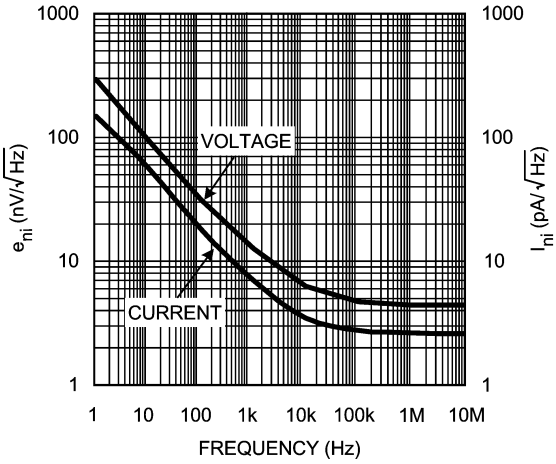

20084336

Output Voltage vs. Output Current (Sinking)

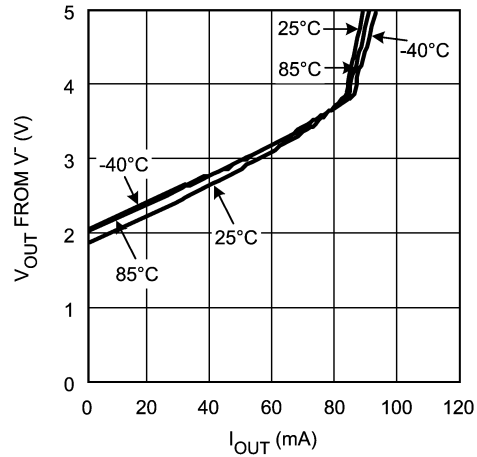

20084365

Output Voltage vs. Output Current (Sourcing)

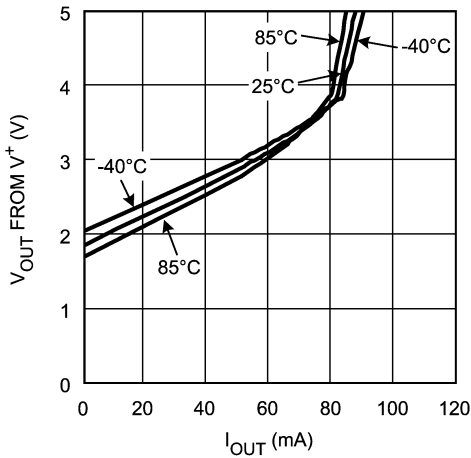

20084331

Distortion vs. Frequency

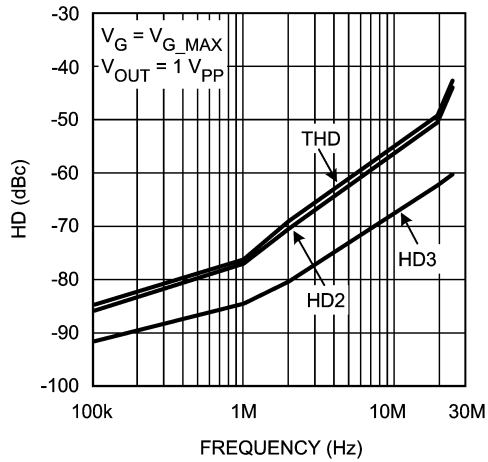

20084342

HD vs. P_OUT

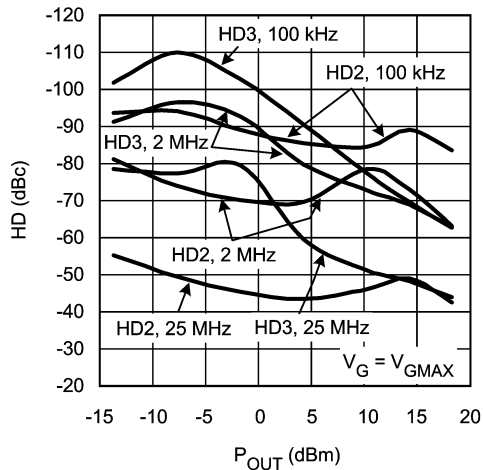

20084343

THD vs. P_OUT

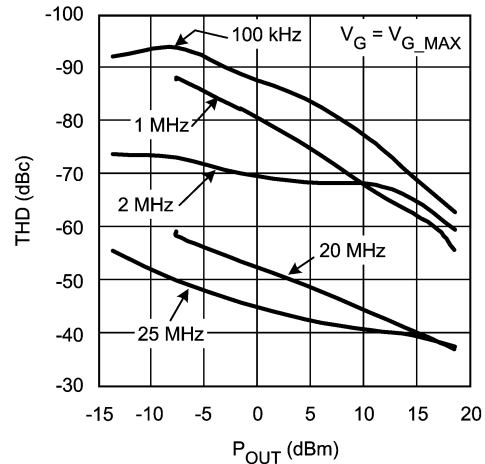

20084309

Typical Performance Characteristics Unless otherwise specified: $V_S = \pm 5V$, $T_A = 25^\circ C$, $V_G = V_{GMAX}$, $R_F = 1\text{ k}\Omega$, $R_G = 100\Omega$, $V_{IN} = 0.1V$, input terminated in 50Ω . $R_L = 100\Omega$, Typical values. (Continued)

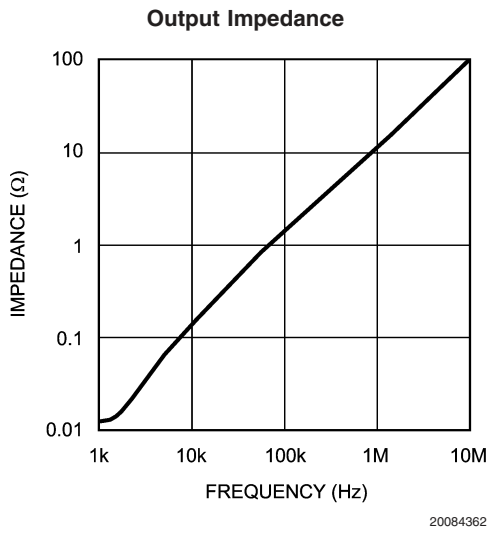
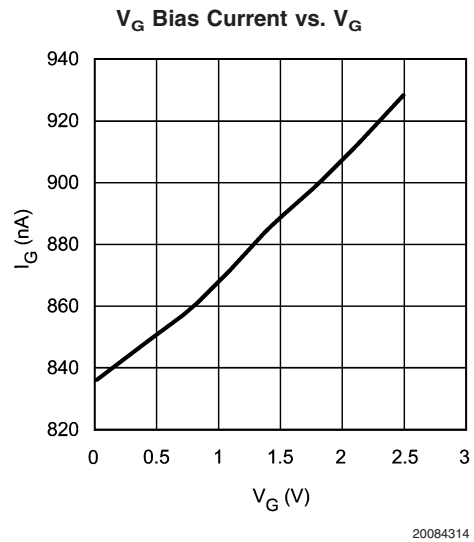
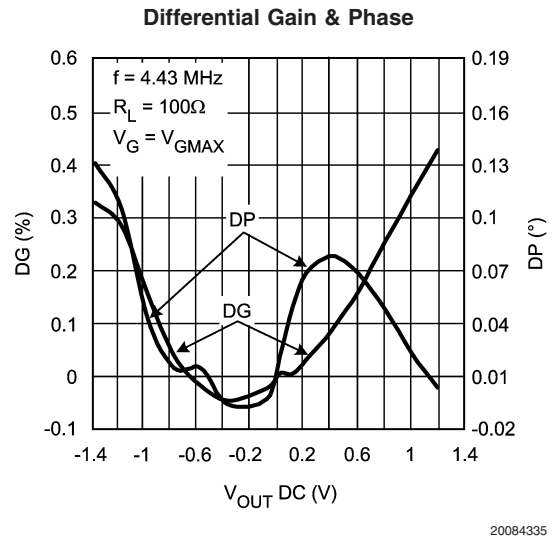
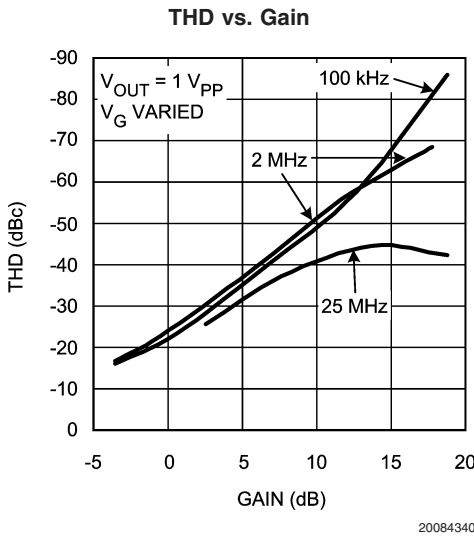
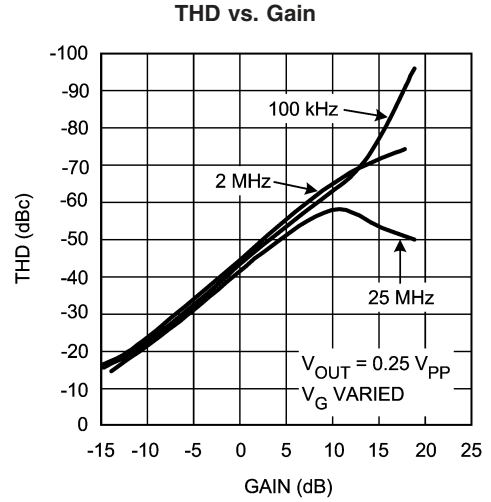
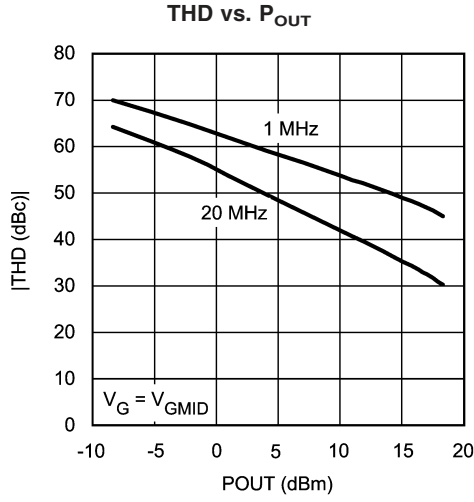

Typical Performance Characteristics Unless otherwise specified: $V_S = \pm 5V$, $T_A = 25^\circ C$, $V_G = V_{GMAX}$, $R_F = 1\text{ k}\Omega$, $R_G = 100\Omega$, $V_{IN} = 0.1V$, input terminated in 50Ω . $R_L = 100\Omega$, Typical values. (Continued)

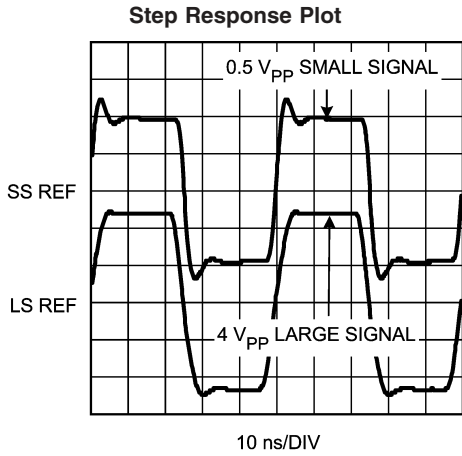

20084315

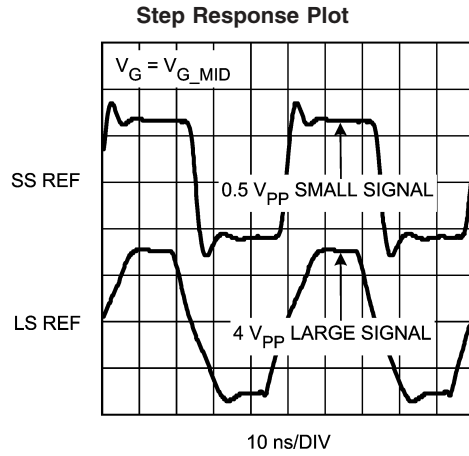

20084317

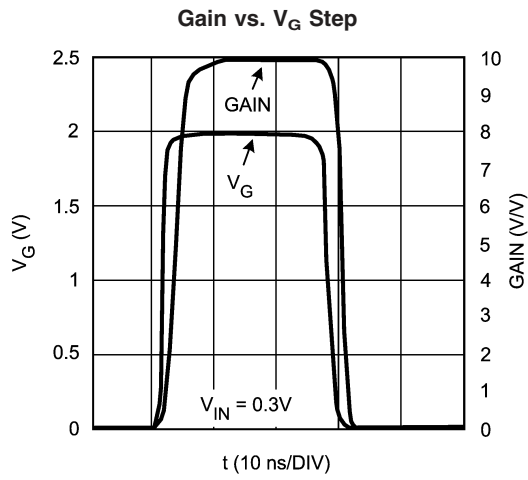

20084332

Application Information

GENERAL DESCRIPTION

The key features of the LMH6504 are:

- Low power
- Broad voltage controlled gain and attenuation range (From A_{VMAX} down to complete cutoff)
- Bandwidth independent, resistor programmable gain range (R_G)
- Broad signal and gain control bandwidths
- Frequency response may be adjusted with R_F
- High impedance signal and gain control inputs

Refer to *Figure 1* below. The LMH6504 combines a closed loop input buffer ("X1" Block), a voltage controlled variable gain cell ("MULT" Block) and an output amplifier ("CFA" Block). The input buffer is a transconductance stage whose gain is set by the gain setting resistor, R_G . The output amplifier is a current feedback op amp and is configured as a transimpedance stage whose gain is set by, and is equal to, the feedback resistor, R_F . The maximum gain, A_{VMAX} , of the LMH6504 is defined by the ratio: $K \cdot R_F / R_G$ where "K" is the gain multiplier with a nominal value of 0.965. As the gain control input (V_G) changes over its 0 to 2V range, the gain is adjusted over a range of about 80 dB relative to the maximum set gain.

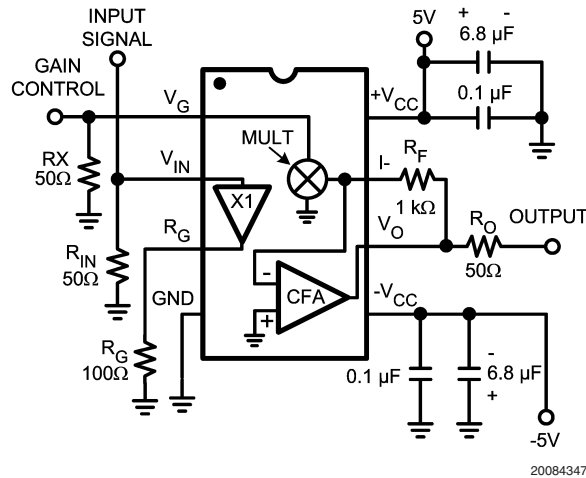

FIGURE 1. LMH6504 Typical Application and Block Diagram

SETTING THE LMH6504 MAXIMUM GAIN

$$A_{VMAX} = \frac{R_F}{R_G} \cdot K$$

Eq. 1

Although the LMH6504 is specified at $A_{VMAX} = 9.7V/V$, the recommended A_{VMAX} varies between 2 and 100. Higher gains are possible but usually impractical due to output offsets, noise and distortion. When varying A_{VMAX} several tradeoffs are made:

R_G : determines the input voltage range

R_F : determines overall bandwidth

The amount of current which the input buffer can source/sink into R_G is limited and is specified in the I_{RG_MAX} spec. This sets the maximum input voltage:

$$V_{IN (MAX)} = I_{RG_MAX} \cdot R_G$$

Eq. 2

As the I_{RG_MAX} limit is approached (with increasing input voltage or with lowering of R_G), the device harmonic distortion will increase. Changes in R_F will have a dramatic effect on the small signal bandwidth. The output amplifier of the LMH6504 is a current feedback amplifier (CFA) and its bandwidth is determined by R_F . As with any CFA, doubling the feedback resistor will roughly cut the bandwidth of the device in half. For more about CFA's, see the basic tutorial, OA-20, "Current Feedback Myths Debunked", or a more rigorous analysis, OA-13, "Current Feedback Amplifier Loop Gain Analysis and Performance Enhancements".

OTHER CONFIGURATIONS

1) Single Supply Operation

The LMH6504 can be configured for use in a single supply environment. Doing so requires the following:

- Bias pin 4 and R_G to a "virtual half supply" somewhere close to the middle of V^+ and V^- range. The other end of R_G is tied to pin 3. The "virtual half supply" needs to be capable of sinking and sourcing the expected current flow through R_G .
- Ensure that V_G can be adjusted from 0V to 2V above the "virtual half supply".
- Bias the input (pin 2) to make sure that it stays within the range of 1.8V above V^- to 1.8V below V^+ (see "Input voltage Range" specification in the Electrical Characteristics table). This can be accomplished by either DC biasing the input and AC coupling the input signal, or alternatively, by direct coupling if the output of the driving stage is also biased to half supply.

Arranged this way, the LMH6504 will respond to the current flowing through R_G . The gain control relationship will be similar to the split supply arrangement with V_G measured referenced to pin 4. Keep in mind that the circuit described above will also center the output voltage to the "virtual half supply voltage".

2) Arbitrarily Referenced Input Signal

Having a wide input voltage range on the input (pin 2) (+/-3.2V typical), the LMH6504 can be configured to control the gain on signals which are not referenced to ground (e.g. Half Supply biased circuits, etc.). We will call this node the "reference node". In such cases, the other end of R_G (the side not tied to pin 3) can be tied to this reference node so that R_G will "look at" the difference between the signal and this reference only. Keep in mind that the reference node needs to source and sink the current flowing through R_G .

GAIN ACCURACY

Gain accuracy is defined as the actual gain compared against the theoretical gain at a certain V_G (results expressed in dB) (See *Figure 2*).

Theoretical gain is given by:

Application Information (Continued)

$$A(V/V) = K \times \frac{R_F}{R_G} \times \frac{1}{1 + e^{\left[\frac{N - V_G}{V_C} \right]}}$$

Eq. 3

Where K = 0.965 (nominal) N = 0.96V & V_C = 80mV @ room temperature

For a V_G range, the value specified in the tables represents the worst case accuracy over the entire range. The "Typical" value would be the worst case difference between the "Typical gain" and the "Theoretical gain". The "Max" value would be the worst case difference between the actual gain and the "Theoretical gain" for the entire population.

GAIN MATCHING

Gain matching as the limit on gain variation at a certain V_G (expressed in dB) (see Figure 2) and is specified as "Max" only (no "Typical"). For a V_G range, the value specified represents the worst case matching over the entire range. The "Max" value would be the worst case difference between the actual gain and the typical gain for the entire population.

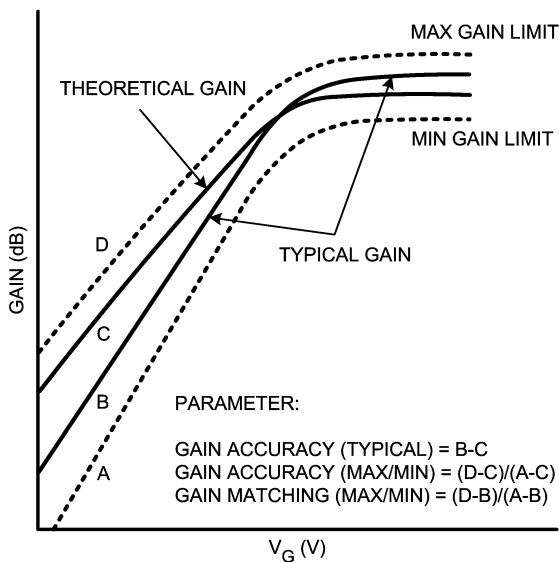

20084351

FIGURE 2. LMH6504 Gain Accuracy & Gain Matching Defined

GAIN PARTITIONING

If high levels of gain are needed, gain partitioning should be considered:

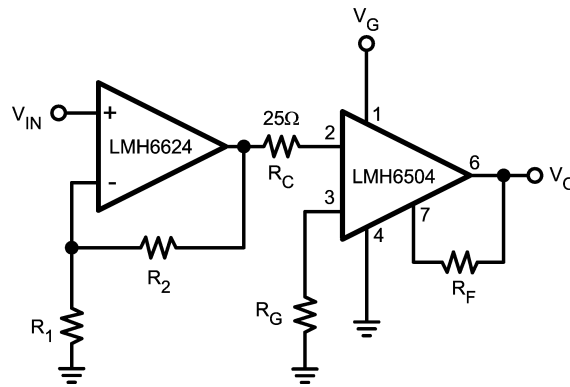

20084352

FIGURE 3. Gain Partitioning

The maximum gain range for this circuit is given by the following equation:

$$\text{MAXIMUM GAIN} = \left[1 + \frac{R_2}{R_1} \right] \cdot \left[\frac{R_F}{R_G} \right] \cdot K$$

Eq. 4

The LMH6624 is a low noise wideband voltage feedback amplifier. Setting R₂ at 909Ω and R₁ at 100Ω produces a gain of 20 dB. Setting R_F at 1000Ω as recommended and R_G at 50Ω, produces a gain of about 26 dB in the LMH6504. The total gain of this circuit is therefore approximately 46 dB. It is important to understand that when partitioning to obtain high levels of gain, very small signal levels will drive the amplifiers to full scale output. For example, with 46 dB of gain, a 20 mV signal at the input will drive the output of the LMH6624 to 200 mV, the output of the LMH6504 to 4V. Accordingly, the designer must carefully consider the contributions of each stage to the overall characteristics. Through gain partitioning the designer is provided with an opportunity to optimize the frequency response, noise, distortion, settling time, and loading effects of each amplifier to achieve improved overall performance.

LMH6504 GAIN CONTROL RANGE AND MINIMUM GAIN

Before discussing Gain Control Range, it is important to understand the issues which limit it. The minimum gain of the LMH6504, theoretically, is zero, but in practical circuits is limited by the amount of feedthrough, here defined as the gain when V_G = 0V. Capacitive coupling through the board and package as well as coupling through the supplies will determine the amount of feedthrough. Even at DC, the input signal will not be completely rejected. At high frequencies feedthrough will get worse because of its capacitive nature. At frequencies below 10 MHz, the feed through will be less than -60 dB and therefore, it can be said that with A_{VMAX} = 20 dB, the gain control range is 80 dB.

Application Information (Continued)

LMH6504 GAIN CONTROL FUNCTION

In the plot, Gain vs. V_G , we can see the gain as a function of the control voltage. The “Gain (V/V)” plot, sometimes referred to as the S-curve, is the linear (V/V) gain. This is a hyperbolic tangent relationship and is given by Equation 3. The “Gain (dB)” plots the gain in dB and is linear over a wide range of gains. Because of this, the LMH6504 gain control is referred to as “linear-in-dB.”

For applications where the LMH6504 will be used at the heart of a closed loop AGC circuit, the S-curve control characteristic provides a broad linear (in dB) control range with soft limiting at the highest gains where large changes in control voltage result in small changes in gain. For applications requiring a fully linear (in dB) control characteristic, use the LMH6504 at half gain and below ($V_G \leq 1V$).

AVOIDING OVERDRIVE OF THE LMH6504 GAIN CONTROL INPUT

There is an additional requirement for the LMH6504 Gain Control Input (V_G): V_G must not exceed +2.3V (with $\pm 5V$ supplies). The gain control circuitry may saturate and the gain may actually be reduced. In applications where V_G is being driven from a DAC, this can easily be addressed in the software. If there is a linear loop driving V_G , such as an AGC loop, other methods of limiting the input voltage should be implemented. One simple solution is to place a 2.2:1 resistive divider on the V_G input. If the device driving this divider is operating off of $\pm 5V$ supplies as well, its output will not exceed 5V and through the divider V_G can not exceed 2.3V.

IMPROVING THE LMH6504 LARGE SIGNAL PERFORMANCE

Figure 4 illustrates an inverting gain scheme for the LMH6504.

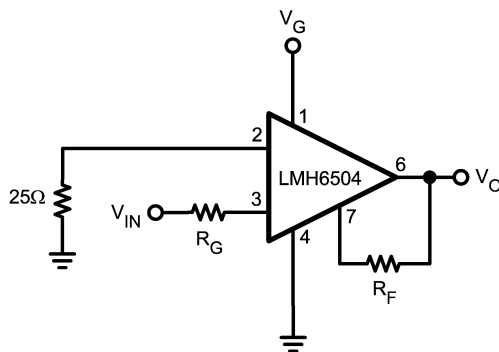

FIGURE 4. Inverting Amplifier

The input signal is applied through the R_G resistor. The V_{IN} pin should be grounded through a 25Ω resistor. The maximum gain range of this configuration is given in the following equation:

$$A_{V_{MAX}} = - \left[\frac{R_F}{R_G} \right] \cdot K$$

Eq. 5

The inverting slew rate of the LMH6504 is much higher than that of the non-inverting slew rate. This 2X performance

improvement comes about because in the non-inverting configuration, the slew rate of the overall amplifier is limited by the input buffer. In the inverting circuit, the input buffer remains at a fixed voltage and does not affect slew rate.

TRANSMISSION LINE MATCHING

One method for matching the characteristic impedance of a transmission line is to place the appropriate resistor at the input or output of the amplifier. Figure 5 shows a typical circuit configuration for matching transmission lines.

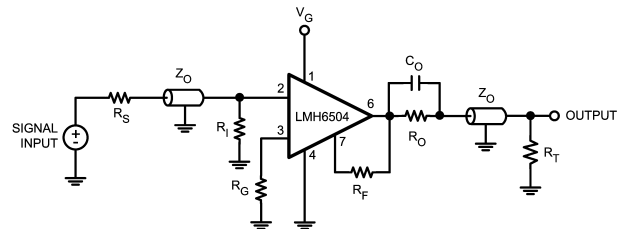

20084356

FIGURE 5. TRANSMISSION LINE MATCHING

The resistors R_S , R_I , R_O , and R_T are equal to the characteristic impedance, Z_O , of the transmission line or cable. Use C_O to match the output transmission line over a greater frequency range. It compensates for the increase of the op amp's output impedance with frequency.

MINIMIZING PARASITIC EFFECTS ON SMALL SIGNAL BANDWIDTH

The best way to minimize parasitic effects is to use surface mount components and to minimize lead lengths and component distance from the LMH6504. For designs utilizing through-hole components, specifically axial resistors, resistor self-capacitance should be considered. Example: the average magnitude of parasitic capacitance of RN55D 1% metal film resistors is about 0.15 pF with variations of as much as 0.1 pF between lots. Given the LMH6504's extended bandwidth, these small parasitic reactance variations can cause measurable frequency response variations in the highest octave. We therefore recommend the use of surface mount resistors to minimize these parasitic reactance effects.

RECOMMENDATIONS

Here are some recommendations to avoid problems and to get the best performance:

- Do not place a capacitor across R_F . However, an appropriately chosen series RC combination could be used to shape the frequency response.
- Keep traces connecting R_F separated and as short as possible
- Place a small resistor (20-50Ω) between the output and C_L
- Cut away the ground plane, if any, under R_G
- Keep decoupling capacitors as close as possible to the LMH6504.
- Connect pin 2 through a minimum resistance of 25Ω.

ADJUSTING OFFSETS AND DC LEVEL SHIFTING

Offsets can be broken into two parts: an input-referred term and an output-referred term. These errors can be trimmed using the circuit in Figure 6. First set V_G to 0V and adjust the

Application Information (Continued)

trim pot R_4 to null the offset voltage at the output. This will eliminate the output stage offsets. Next set V_G to 2V and adjust the trim pot R_1 to null the offset voltage at the output. This will eliminate the input stage offsets.

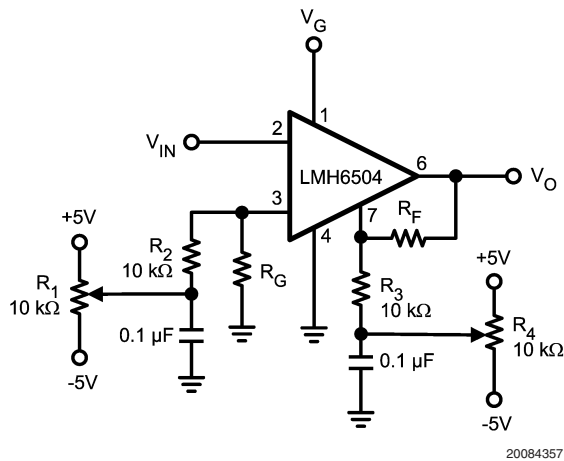

FIGURE 6. OFFSET ADJUST CIRCUIT

DIGITAL GAIN CONTROL

Digitally variable gain control can be easily realized by driving the LMH6504's gain control input with a digital-to-analog converter (DAC). Figure 7 illustrates such an application. This circuit employs National Semiconductor's eight-bit DAC0830, the LMC8101 MOS input op-amp (Rail-to-Rail Input/Output), and the LMH6504 VGA. With V_{REF} set to 2V, the circuit provides up to 80 dB of gain control in 256 steps with up to 0.05% full scale resolution. The maximum gain of this circuit is 20 dB.

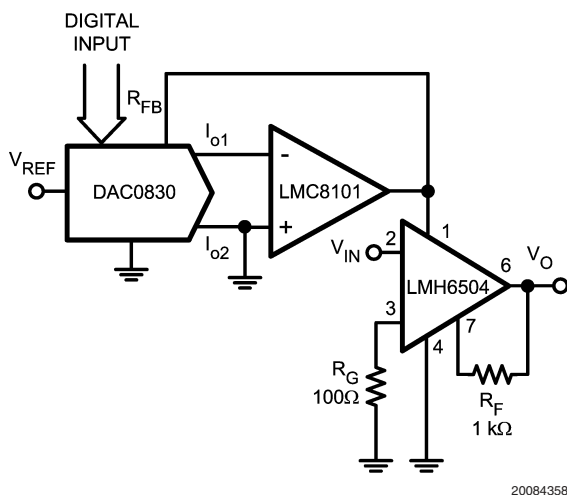

FIGURE 7. Digital Gain Control

USING THE LMH6504 IN AGC APPLICATIONS

In AGC applications, the control loop forces the LMH6504 to have a fixed output amplitude. The input amplitude will vary over a wide range and this can be the issue that limits dynamic range. At high input amplitudes, the distortion due to the input buffer driving R_G may exceed that which is produced by the output amplifier driving the load. In the plot, Distortion vs. Gain, total harmonic distortion (THD) is plotted over a gain range of nearly 35 dB for a fixed output amplitude of $0.25 V_{PP}$ in the specified configuration, $R_F = 1k$, $R_G = 100\Omega$. When the gain is adjusted to -15 dB (i.e. 35 dB down from A_{VMAX}), the input amplitude would be $1.41 V_{PP}$ and we can see the distortion is at its worst at this gain. If the output amplitude of the AGC were to be raised above $0.25 V_{PP}$, the input amplitudes for gains 40 dB down from A_{VMAX} would be even higher and the distortion would degrade further. It is for this reason that we recommend lower output amplitudes if wide gain ranges are desired. Using a post-amp like the LMH6714/ 6720/ 6722 family or LMH6702 would be the best way to preserve dynamic range and yield output amplitudes much higher than $100 mV_{PP}$. Another way of addressing distortion performance and its limitations on dynamic range, would be to raise the value of R_G . Just like any other high-speed amplifier, by increasing the load resistance, and therefore decreasing the demanded load current, the distortion performance will be improved in most cases. With an increased R_G , R_F will also have to be increased to keep the same A_{VMAX} and this will decrease the overall bandwidth. It may be possible to insert a series RC combination across R_F in order to counteract the negative effect on BW when a large R_F is used.

AUTOMATIC GAIN CONTROL (AGC) #1

Fast Response AGC Loop

The AGC circuit shown in Figure 8 will correct a 6 dB input amplitude step in 100 ns. The circuit includes a two op-amp precision rectifier amplitude detector (U1 and U2), and an integrator (U3) to provide high loop gain at low frequencies. The output amplitude is set by R_G . Some notes on building fast AGC loops: Precision rectifiers work best with large output signals. Accuracy is improved by blocking DC offsets, as shown in Figure 8.

Physical Dimensions inches (millimeters) unless otherwise noted

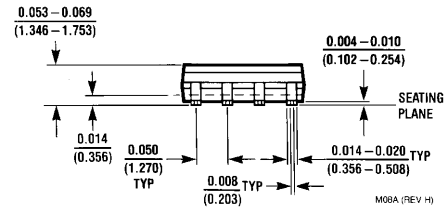
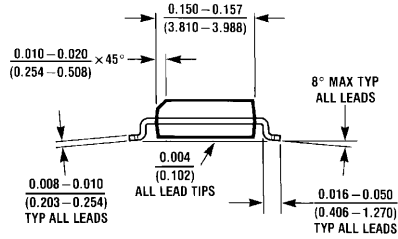
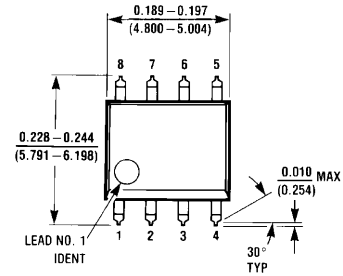

8-Pin SOIC
NS Package Number M08A

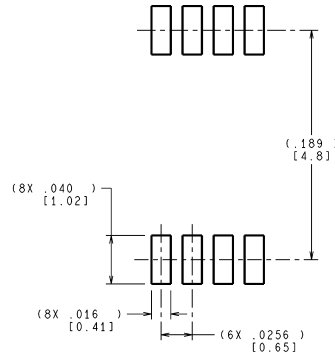
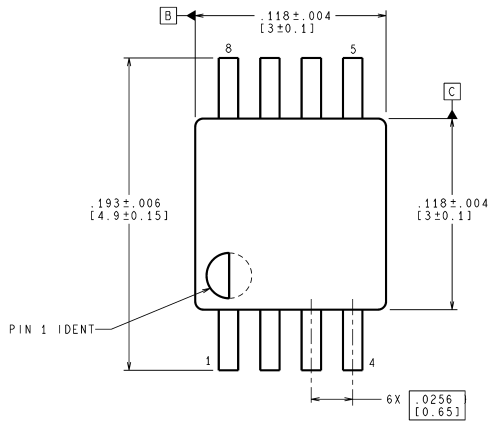

LAND PATTERN RECOMMENDATION

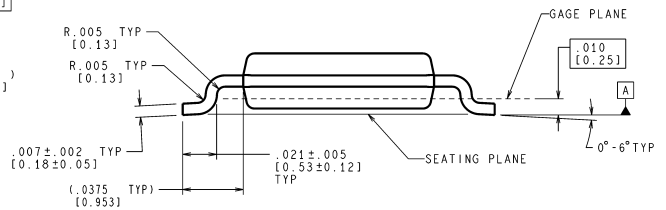
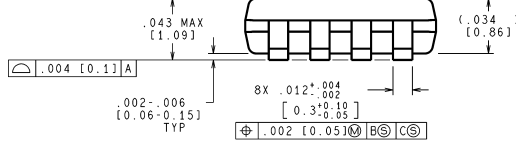

CONTROLLING DIMENSION IS INCH
VALUES IN [] ARE MILLIMETERS

MUA08A (Rev E)

8-Pin MSOP
NS Package Number MUA08A

Notes

LIFE SUPPORT POLICY

NATIONAL'S PRODUCTS ARE NOT AUTHORIZED FOR USE AS CRITICAL COMPONENTS IN LIFE SUPPORT DEVICES OR SYSTEMS WITHOUT THE EXPRESS WRITTEN APPROVAL OF THE PRESIDENT AND GENERAL COUNSEL OF NATIONAL SEMICONDUCTOR CORPORATION. As used herein:

1. Life support devices or systems are devices or systems which, (a) are intended for surgical implant into the body, or (b) support or sustain life, and whose failure to perform when properly used in accordance with instructions for use provided in the labeling, can be reasonably expected to result in a significant injury to the user.
2. A critical component is any component of a life support device or system whose failure to perform can be reasonably expected to cause the failure of the life support device or system, or to affect its safety or effectiveness.

BANNED SUBSTANCE COMPLIANCE

National Semiconductor certifies that the products and packing materials meet the provisions of the Customer Products Stewardship Specification (CSP-9-111C2) and the Banned Substances and Materials of Interest Specification (CSP-9-111S2) and contain no "Banned Substances" as defined in CSP-9-111S2.



National Semiconductor
Americas Customer
Support Center
Email: new.feedback@nsc.com
Tel: 1-800-272-9959

www.national.com

National Semiconductor
Europe Customer Support Center
Fax: +49 (0) 180-530 85 86
Email: europa.support@nsc.com
Deutsch Tel: +49 (0) 69 9508 6208
English Tel: +44 (0) 870 24 0 2171
Français Tel: +33 (0) 1 41 91 8790

National Semiconductor
Asia Pacific Customer
Support Center
Email: ap.support@nsc.com

National Semiconductor
Japan Customer Support Center
Fax: 81-3-5639-7507
Email: jpn.feedback@nsc.com
Tel: 81-3-5639-7560