

DS96176 RS-485/RS-422 Differential Bus Transceiver

General Description

The DS96176 Differential Bus Transceiver is a monolithic integrated circuit designed for bidirectional data communication on balanced multipoint bus transmission lines. The transceiver meets EIA Standard RS-485 as well as RS-422A.

The DS96176 combines a TRI-STATE® differential line driver and a differential input line receiver, both of which operate from a single 5.0V power supply. The driver and receiver have an active Enable that can be externally connected to function as a direction control. The driver differential outputs and the receiver differential inputs are internally connected to form differential input/output (I/O) bus ports that are designed to offer minimum loading to the bus whenever the driver is disabled or when $V_{CC} = 0V$. These ports feature wide positive and negative common mode voltage ranges, making the device suitable for multipoint applications in noisy environments.

The driver is designed to handle loads up to 60 mA of sink or source current. The driver features positive and negative current-limiting and thermal shutdown for protection from line fault conditions. Thermal shutdown is designed to occur at junction temperature of approximately 160°C. The receiver features a typical input impedance of 15 kΩ, an input sensitivity of ±200 mV, and a typical input hysteresis of 50 mV.

The DS96176 can be used in transmission line applications employing the DS96172 and the DS96174 quad differential line drivers and the DS96173 and DS96175 quad differential line receivers.

Features

- Bidirectional transceiver
- Meets EIA Standard RS-422A and RS-485
- Designed for multipoint transmission
- TRI-STATE driver and receiver enables
- Individual driver and receiver enables
- Wide positive and negative input/output bus voltage ranges
- Driver output capability ±60 mA Maximum
- Thermal shutdown protection
- Driver positive and Negative current-limiting
- High impedance receiver input
- Receiver input sensitivity of ±200 mV
- Receiver input hysteresis of 50 mV typical
- Operates from single 5.0V supply
- Low power requirements

Connection Diagram

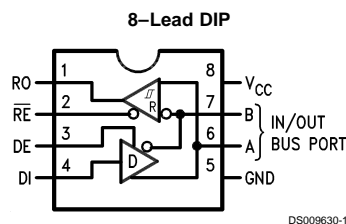

Top View
Order Number DS96176CN
See NS Package Number N08E

Receiver

Differential Inputs	Enable	Output
A-B	\overline{RE}	R
$V_{ID} \geq 0.2V$	L	H
$V_{ID} \leq -0.2V$	L	L
X	H	Z

H = High Level
L = Low Level
X = Immaterial
Z = High Impedance (off)

Function Table

Driver

Input	Enable	Outputs	
DI	DE	A	B
H	H	H	L
L	H	L	H
X	L	Z	Z

TRI-STATE® is a registered trademark of National Semiconductor Corporation.

Absolute Maximum Ratings (Note 2)

If Military/Aerospace specified devices are required, please contact the National Semiconductor Sales Office/Distributors for availability and specifications.

Storage Temperature Range	
Molded DIP	-65°C to +150°C
Lead Temperature	
Molded DIP (soldering, 10 sec.)	265°C
Maximum Power Dissipation (Note 1) at 25°C	
Molded Package	930 mW
Supply Voltage	7.0V
Differential Input Voltage	+15V/-10V
Enable Input Voltage	5.5V

Recommended Operating Conditions

	Min	Typ	Max	Units
Supply Voltage (V_{CC})	4.75	5.0	5.25	V
Voltage at Any Bus Terminal (Separately or Common Mode)	-7.0		12	V
Differential Input Voltage (V_{ID})			±12	V
Output Current HIGH (I_{OH})				
Driver			-60	mA
Receiver			-400	µA
Output Current LOW (I_{OL})				
Driver			60	mA
Receiver			16	mA
Operating Temperature (T_A)	0	25	70	°C

Note 1: Derate molded DIP package 7.5 mW/°C above 25°C.

Electrical Characteristics (Notes 3, 4)

Over recommended temperature, common mode input voltage, and supply voltage ranges, unless otherwise specified

Symbol	Parameter	Conditions	Min	Typ	Max	Units
DRIVER SECTION						
V_{IH}	Input Voltage HIGH		2.0			V
V_{IL}	Input Voltage LOW				0.8	V
V_{OH}	Output Voltage HIGH	$I_{OH} = -20$ mA		3.1		V
V_{OL}	Output Voltage LOW	$I_{OL} = 20$ mA		0.85		V
V_{IC}	Input Clamp Voltage	$I_I = -18$ mA			-1.5	V
$ V_{OD1} $	Differential Output Voltage	$I_O = 0$ mA			6.0	V
$ V_{OD2} $	Differential Output Voltage	$R_L = 100\Omega$, Figure 1	2.0	2.25		V
		$R_L = 54\Omega$, Figure 1 and Figure 2	1.5	2.0		V
$\Delta V_{OD2} $	Change in Magnitude of Differential Output Voltage (Note 5)	$R_L = 54\Omega$ $V_{CM} = 0V$ Figure 1 and Figure 2 $R_L = 100\Omega$ Figure 1			±0.2	V
V_{OC}	Common Mode Output Voltage (Note 6)	$R_L = 54\Omega$ or 100Ω , Figure 1			3.0	V
$\Delta V_{OC} $	Change in Magnitude of Common Mode Output Voltage (Note 5)				±0.2	V
I_O	Output Current (Note 5) (Includes Receiver I_I)	Output Disabled			1.0	mA
		$V_O = 12V$			-0.8	mA
		$V_O = -7.0V$				mA
I_{IH}	Input Current HIGH	$V_I = 2.4V$			20	µA
I_{IL}	Input Current LOW	$V_I = 0.4V$			-100	µA
I_{OS}	Short Circuit Output Current (Note 10)	$V_O = -7.0V$			-250	mA
		$V_O = 0V$			-150	mA
		$V_O = V_{CC}$			150	mA
		$V_O = 12V$			250	mA
I_{CC}	Supply Current	No Load			35	mA
		Outputs Enabled			40	mA
		Outputs Disabled			40	mA
RECEIVER SECTION						
V_{TH}	Differential Input High Threshold Voltage	$V_O = 2.7V$, $I_O = -0.4$ mA			0.2	V
V_{TL}	Differential Input Low Threshold Voltage (Note 7)	$V_O = 0.5V$, $I_O = 8.0$ mA	-0.2			V
$V_{T+} - V_{T-}$	Hysteresis (Note 8)	$V_{CM} = 0V$		50		mV
V_{IH}	Enable Input Voltage HIGH		2.0			V
V_{IL}	Enable Input Voltage LOW				0.8	V
V_{IC}	Enable Input Clamp Voltage	$I_I = -18$ mA			-1.5	V

Electrical Characteristics (Notes 3, 4) (Continued)

Over recommended temperature, common mode input voltage, and supply voltage ranges, unless otherwise specified

Symbol	Parameter	Conditions	Min	Typ	Max	Units
RECEIVER SECTION						
V_{OH}	Output Voltage HIGH	$V_{ID} = 200\text{ mV}$, $I_{OH} = -400\text{ }\mu\text{A}$, <i>Figure 3</i>	2.7			V
V_{OL}	Output Voltage LOW	$V_{ID} = -200\text{ mV}$, <i>Figure 3</i>			0.45 0.50	V
I_{OZ}	High Impedance State Output	$V_O = 0.45\text{V to }2.4\text{V}$			± 20	μA
I_I	Line Input Current (Note 9)	Other Input = 0V		$V_I = 12\text{V}$ $V_I = -7.0\text{V}$	1.0 0.8	mA
I_{IH}	Enable Input Current HIGH	$V_{IH} = 2.7\text{V}$			20	μA
I_{IL}	Enable Input Current LOW	$V_{IL} = 0.4\text{V}$			-100	μA
R_I	Input Resistance			12		k Ω
I_{OS}	Short Circuit Output Current	(Note 10)	-15		-85	mA
I_{CC}	Supply Current (Total Package)	No Load			40	mA
		Outputs Enabled				
		Outputs Disabled				

Driver Switching Characteristics

$V_{CC} = 5\text{V}$, $T_A = 25^\circ\text{C}$

Symbol	Parameter	Conditions	Min	Typ	Max	Units
t_{DD}	Differential Output Delay Time	$R_L = 60\Omega$, <i>Figure 4</i>		15	25	ns
t_{TD}	Differential Output Transition Time	$R_L = 60\Omega$, <i>Figure 4</i>		15	25	ns
t_{PLH}	Propagation Delay Time, Low-to-High Level Output	$R_L = 27\Omega$, <i>Figure 5</i>		12	20	ns
t_{PHL}	Propagation Delay Time, High-to-Low Level Output	$R_L = 27\Omega$, <i>Figure 5</i>		12	20	ns
t_{PZH}	Output Enable Time to High Level	$R_L = 110\Omega$, <i>Figure 6</i>		25	35	ns
t_{PZL}	Output Enable Time to Low Level	$R_L = 110\Omega$, <i>Figure 7</i>		25	35	ns
t_{PHZ}	Output Disable Time from High Level	$R_L = 110\Omega$, <i>Figure 6</i>		20	25	ns
t_{PLZ}	Output Disable Time from Low Level	$R_L = 110\Omega$, <i>Figure 7</i>		29	35	ns

Receiver Switching Characteristics

$V_{CC} = 5.0\text{V}$, $T_A = 25^\circ\text{C}$

Symbol	Parameter	Conditions	Min	Typ	Max	Units
t_{PLH}	Propagation Delay Time, Low-to-High Level Output	$V_{ID} = 0\text{V to }3.0\text{V}$ $C_L = 15\text{ pF}$, <i>Figure 8</i>		16	25	ns
t_{PHL}	Propagation Delay Time, High-to-Low Level Output			16	25	ns
t_{PZH}	Output Enable Time to High Level	$C_L = 15\text{ pF}$, <i>Figure 9</i>		15	22	ns
t_{PZL}	Output Enable Time to Low Level			15	22	ns
t_{PHZ}	Output Disable Time from High Level	$C_L = 5.0\text{ pF}$, <i>Figure 9</i>		14	30	ns
t_{PLZ}	Output Disable Time from Low Level			24	40	ns

Note 2: "Absolute Maximum Ratings" are those values beyond which the safety of the device cannot be guaranteed. They are not meant to imply that the devices should be operated at these limits. The tables of "Electrical Characteristics" provide conditions for actual operation.

Note 3: Unless otherwise specified min/max limits apply across the 0°C to $+70^\circ\text{C}$ range for the DS96176. All typicals are given for $V_{CC} = 5\text{V}$ and $T_A = 25^\circ\text{C}$.

Note 4: All currents into the device pins are positive; all currents out of the device pins are negative. All voltages are referenced to ground unless otherwise specified.

Note 5: $\Delta|V_{OD}|$ and $\Delta|V_{OC}|$ are the changes in magnitude of V_{OD} and V_{OC} , respectively, that occur when the input is changed from a high level to a low level.

Note 6: In EIA Standards RS-422A and RS-485, V_{OC} , which is the average of the two output voltages with respect to ground, is called output offset voltage, V_{OS} .

Note 7: The algebraic convention, where the less positive (more negative) limit is designated minimum, is used in this data sheet for common mode input voltage and threshold voltage levels only.

Note 8: Hysteresis is the difference between the positive-going input threshold voltage V_{T+} , and the negative-going input threshold voltage, V_{T-} .

Receiver Switching Characteristics (Continued)

Note 9: Refer to EIA Standard RS-485 for exact conditions.

Note 10: Only one output at a time should be shorted.

Parameter Measurement Information

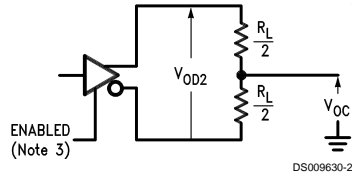

FIGURE 1. Driver V_{OD} and V_{OC}

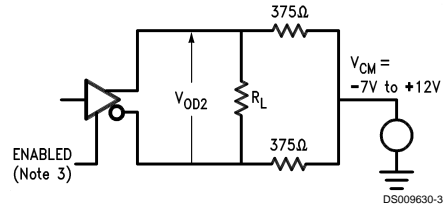

FIGURE 2. Driver V_{OD} with Varying Common Mode Voltage

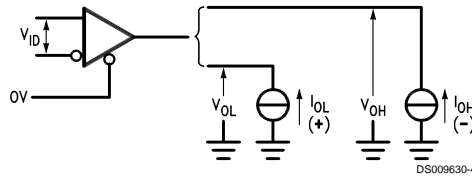

FIGURE 3. Receiver V_{OH} and V_{OL}

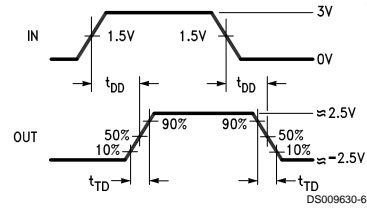
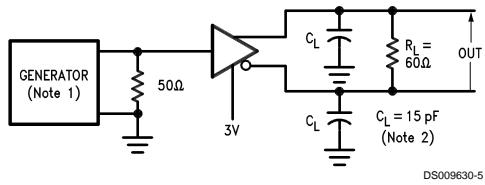

FIGURE 4. Driver Differential Output Delay and Transition Times

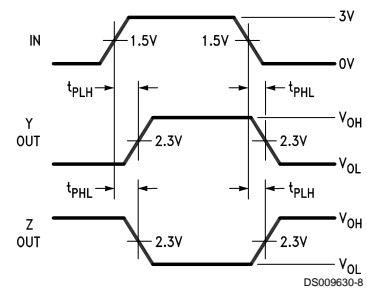
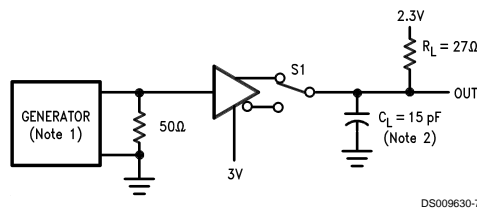

FIGURE 5. Driver Propagation Times

Parameter Measurement Information (Continued)

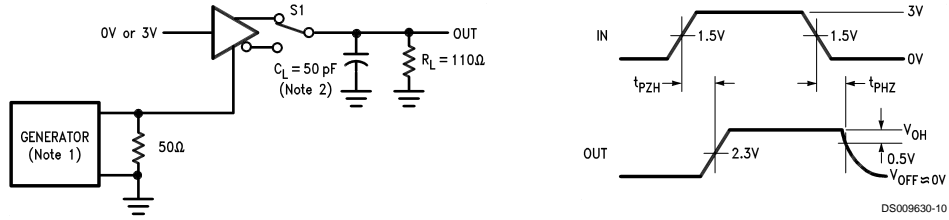

FIGURE 6. Driver Enable and Disable Times (t_{PZH} , t_{PHZ})

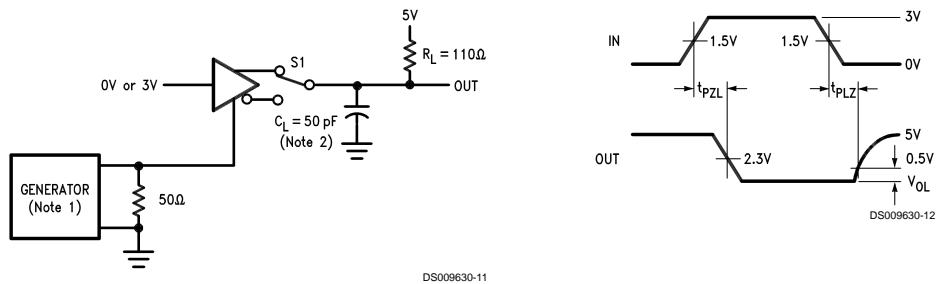

FIGURE 7. Driver Enable and Disable Times (t_{PZL} , t_{PLZ})

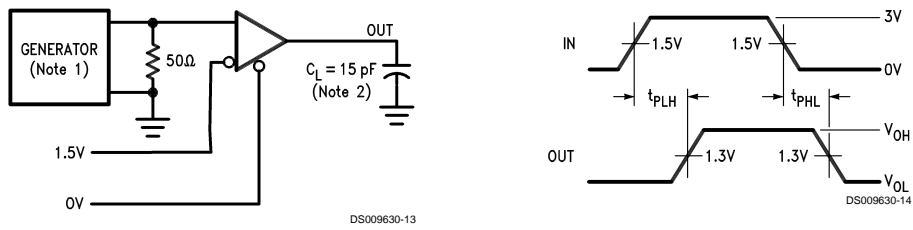
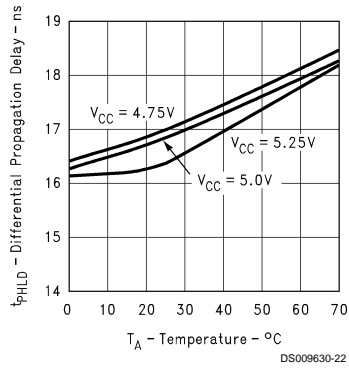

FIGURE 8. Receiver Propagation Delay Times

Typical Performance Characteristics

Driver Differential Propagation Delay vs V_{CC} vs Temperature



Driver Differential Propagation Delay vs V_{CC} vs Temperature

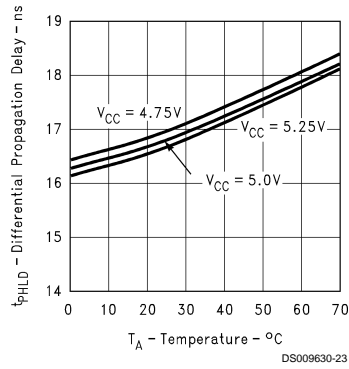

Driver Differential Rise Time vs V_{CC} vs Temperature

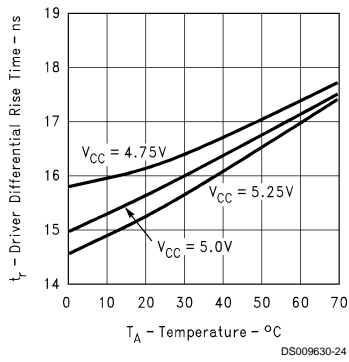

Driver Differential Fall Time vs V_{CC} vs Temperature

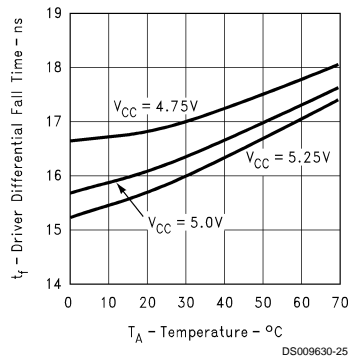

Driver Skew vs V_{CC} vs Temperature
($|t_{PLDH} - t_{PHLD}|$)

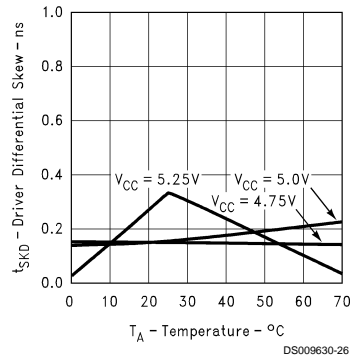

Typical Performance Characteristics (Continued)

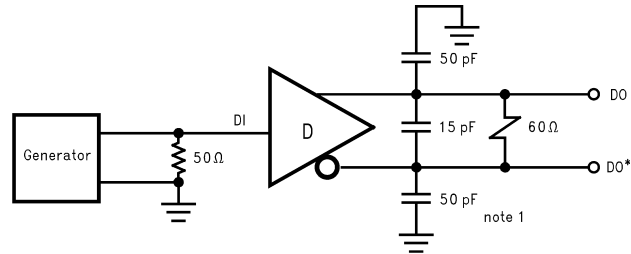

DS009630-27

FIGURE 11. Typical Curve Driver Propagation Delay Test Circuit

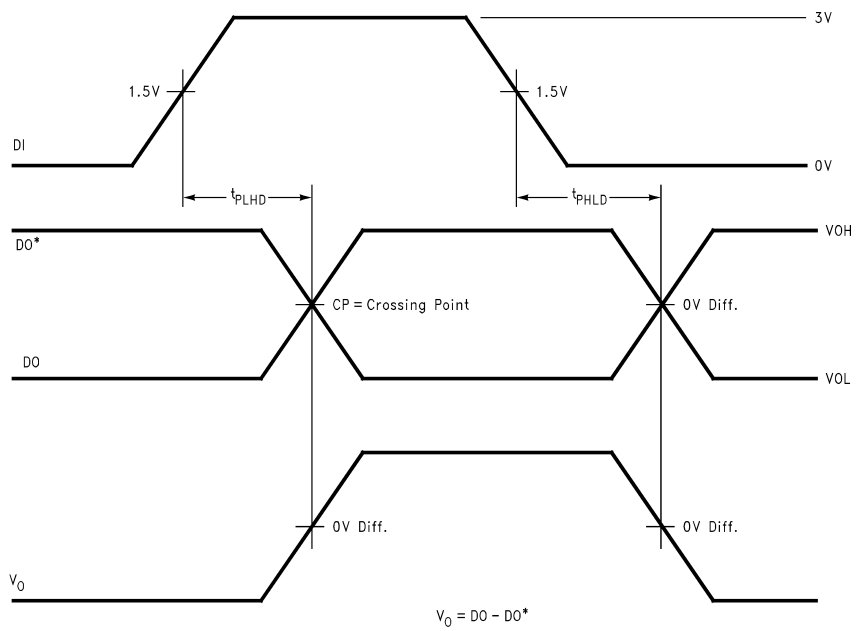

DS009630-28

FIGURE 12. Typical Curve Driver Differential Propagation Delay Timing

Typical Performance Curves

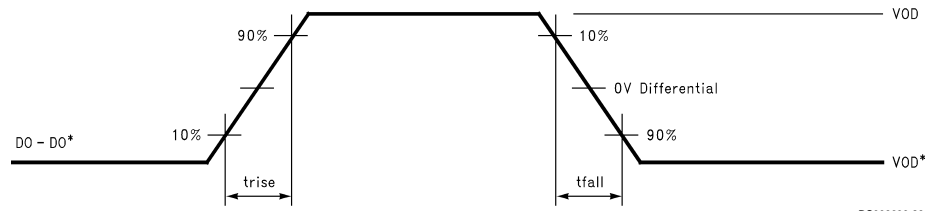
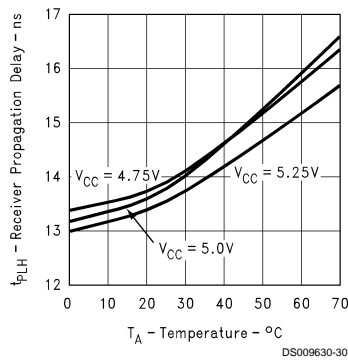
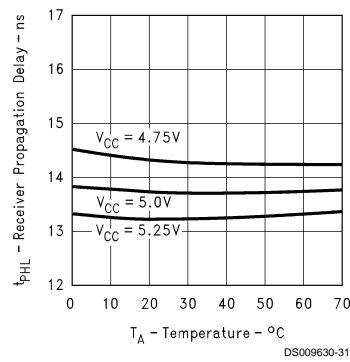

FIGURE 13. Typical Curve Driver Differential Rise and Fall Times

Receiver Propagation Delay vs V_{CC} vs Temperature



Receiver Propagation Delay vs V_{CC} vs Temperature



Receiver Skew vs V_{CC} vs Temperature ($t_{PLH} - t_{PHL}$)

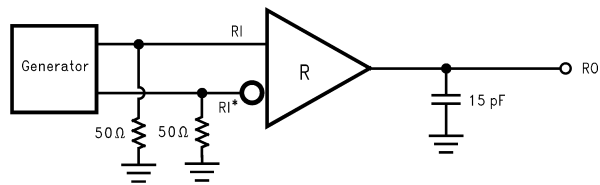
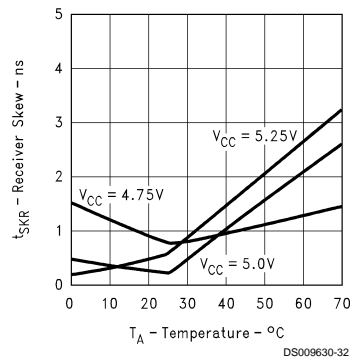

FIGURE 14. Typical Curve Receiver Differential Propagation Delay Test Circuit

Typical Performance Curves (Continued)

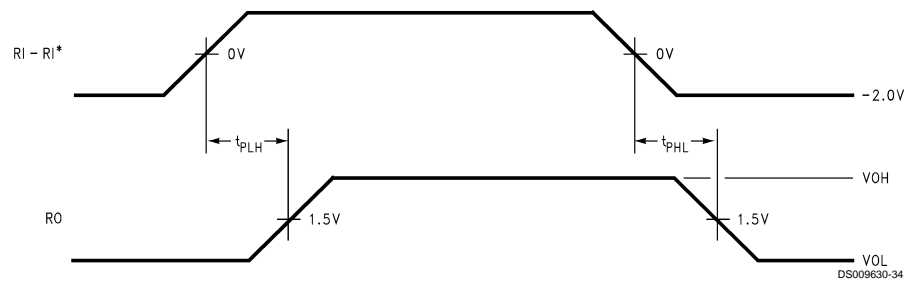
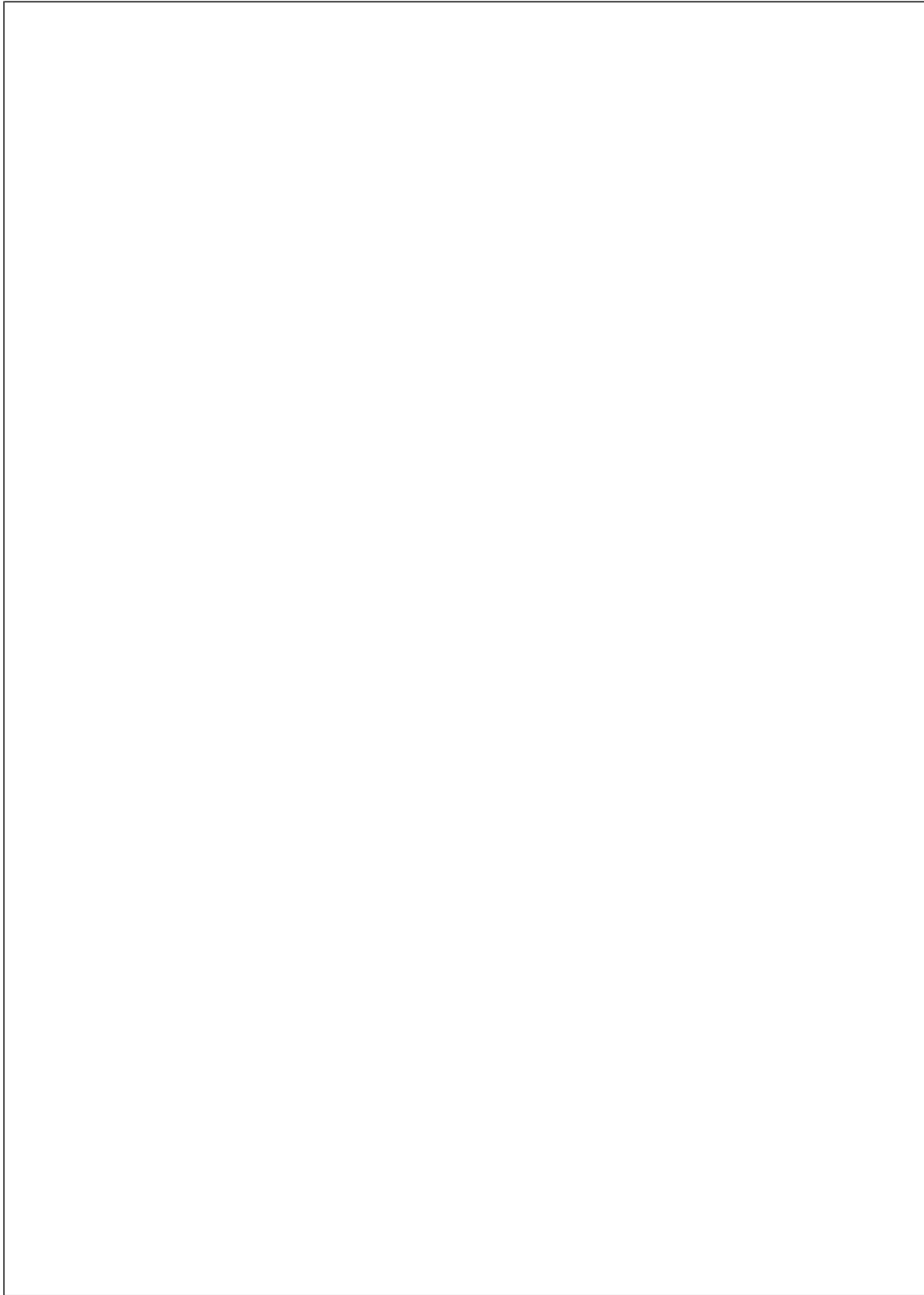
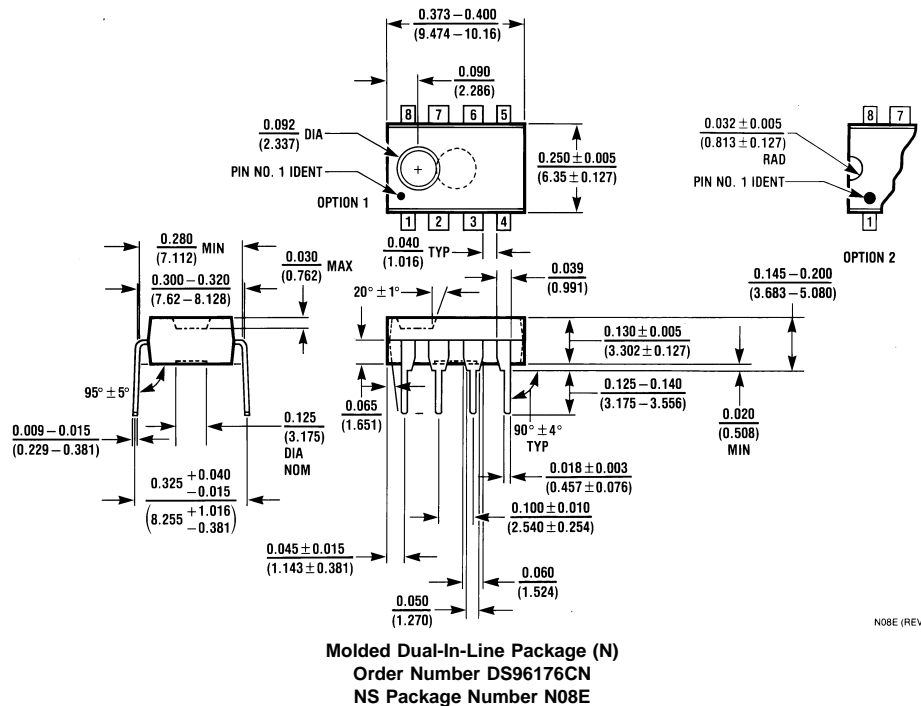

FIGURE 15. Typical Curve Receiver Propagation Delay Timing



Physical Dimensions inches (millimeters) unless otherwise noted



LIFE SUPPORT POLICY

NATIONAL'S PRODUCTS ARE NOT AUTHORIZED FOR USE AS CRITICAL COMPONENTS IN LIFE SUPPORT DEVICES OR SYSTEMS WITHOUT THE EXPRESS WRITTEN APPROVAL OF THE PRESIDENT OF NATIONAL SEMICONDUCTOR CORPORATION. As used herein:

1. Life support devices or systems are devices or systems which, (a) are intended for surgical implant into the body, or (b) support or sustain life, and whose failure to perform when properly used in accordance with instructions for use provided in the labeling, can be reasonably expected to result in a significant injury to the user.
2. A critical component in any component of a life support device or system whose failure to perform can be reasonably expected to cause the failure of the life support device or system, or to affect its safety or effectiveness.



National Semiconductor Corporation
 Americas
 Tel: 1-800-272-9959
 Fax: 1-800-737-7018
 Email: support@nsc.com

National Semiconductor Europe
 Fax: +49 (0) 1 80-530 85 86
 Email: europe.support@nsc.com
 Deutsch Tel: +49 (0) 1 80-530 85 85
 English Tel: +49 (0) 1 80-532 78 32
 Français Tel: +49 (0) 1 80-532 93 58
 Italiano Tel: +49 (0) 1 80-534 16 80

National Semiconductor Asia Pacific Customer Response Group
 Tel: 65-2544466
 Fax: 65-2504466
 Email: sea.support@nsc.com

National Semiconductor Japan Ltd.
 Tel: 81-3-5620-6175
 Fax: 81-3-5620-6179

www.national.com

National does not assume any responsibility for use of any circuitry described, no circuit patent licenses are implied and National reserves the right at any time without notice to change said circuitry and specifications.