

TOSHIBA Bipolar Linear Integrated Circuit Silicon Monolithic

TA7805F,TA78057F,TA7806F,TA7807F,TA7808F,TA7809F, TA7810F,TA7812F,TA7815F,TA7818F,TA7820F,TA7824F

Three Terminal Positive Voltage Regulators

5 V, 5.7 V, 6 V, 7 V, 8 V, 9 V, 10 V, 12 V, 15 V, 18 V, 20 V, 24 V

Features

- Suitable for CMOS, TTL, the other digital IC's power supply.
- Internal thermal overload protection.
- Internal short circuit current limiting.
- Maximum output current of 1 A.
- Packaged in POWER MOLD.

Pin Assignment

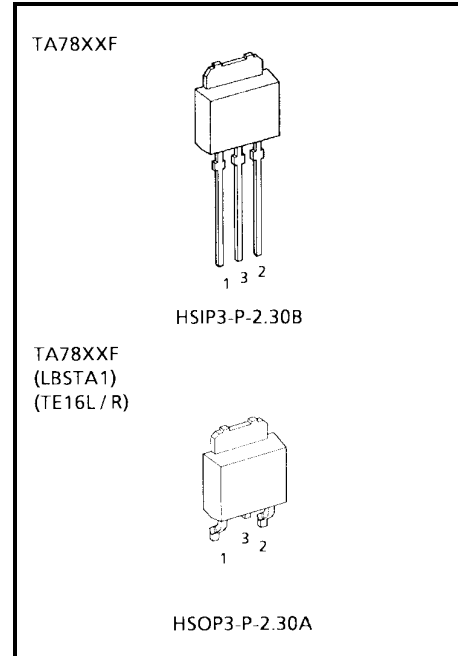
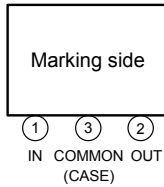

Weight

HSIP3-P-2.30B: 0.36 g (Typ.)

HSOP3-P-2.30A: 0.36 g (Typ.)

Equivalent Circuit

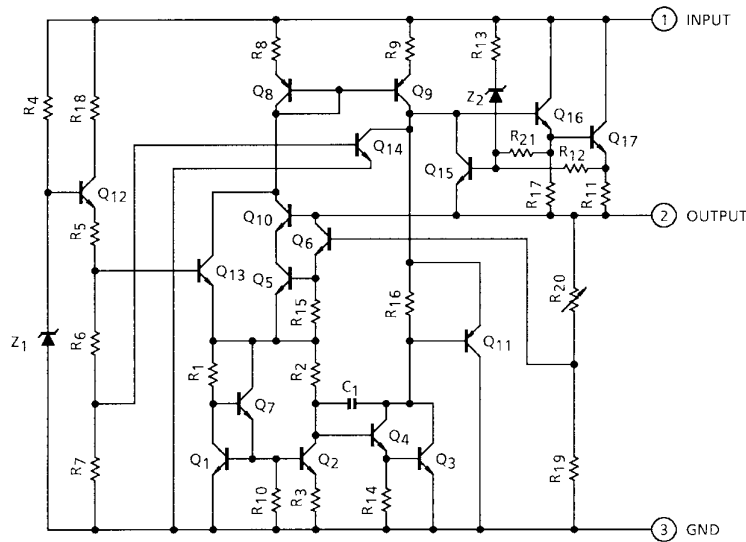

Maximum Ratings (Ta = 25°C)

Characteristics	Symbol	Rating	Unit	
Input voltage	V _{IN}	35	V	
				TA7805F
				TA78057F
				TA7806F
				TA7807F
				TA7808F
				TA7809F
				TA7810F
				TA7812F
				TA7815F
		TA7818F		
		TA7820F		
TA7824F	40			
Power dissipation	P _D	(Ta = 25°C)	1	
		(Tc = 25°C)	10	
Operating temperature	T _{opr}	-30~85	°C	
Storage temperature	T _{stg}	-55~150	°C	
Junction temperature	T _j	150	°C	
Thermal resistance	R _{th(j-c)}	12.5	°C/W	
	R _{th(j-a)}	125		

TA7805F

Electrical Characteristics

(Unless otherwise specified, $V_{IN} = 10\text{ V}$, $I_{OUT} = 500\text{ mA}$, $0^\circ\text{C} \leq T_j \leq 125^\circ\text{C}$)

Characteristics	Symbol	Test Circuit	Test Condition	Min	Typ.	Max	Unit	
Output voltage	V_{OUT}	1	$T_j = 25^\circ\text{C}$, $I_{OUT} = 100\text{ mA}$	4.8	5.0	5.2	V	
Line regulation	Reg-line	1	$T_j = 25^\circ\text{C}$	$7.0\text{ V} \leq V_{IN} \leq 25\text{ V}$	—	3	100	mV
				$8.0\text{ V} \leq V_{IN} \leq 12\text{ V}$	—	1	50	
Load regulation	Reg-load	1	$T_j = 25^\circ\text{C}$	$5\text{ mA} \leq I_{OUT} \leq 1.4\text{ A}$	—	15	100	mV
				$250\text{ mA} \leq I_{OUT} \leq 750\text{ mA}$	—	5	50	
Output voltage	V_{OUT}	1	$T_j = 25^\circ\text{C}$ $7.0\text{ V} \leq V_{IN} \leq 20\text{ V}$ $5.0\text{ mA} \leq I_{OUT} \leq 1.0\text{ A}$	4.75	—	5.25	V	
Quiescent current	I_B	1	$T_j = 25^\circ\text{C}$, $I_{OUT} = 5\text{ mA}$	—	4.2	8.0	mA	
Quiescent current change	ΔI_B	1	$7.0\text{ V} \leq V_{IN} \leq 25\text{ V}$, $I_{OUT} = 5\text{ mA}$, $T_j = 25^\circ\text{C}$	—	—	1.3	mA	
Output noise voltage	V_{NO}	2	$T_a = 25^\circ\text{C}$, $10\text{ Hz} \leq f \leq 100\text{ kHz}$ $I_{OUT} = 50\text{ mA}$	—	50	—	μV_{rms}	
Ripple rejection	R.R.	3	$f = 120\text{ Hz}$, $10\text{ V} \leq V_{IN} \leq 18\text{ V}$ $I_{OUT} = 50\text{ mA}$, $T_j = 25^\circ\text{C}$	57	73	—	dB	
Dropout voltage	V_D	1	$I_{OUT} = 1.0\text{ A}$, $T_j = 25^\circ\text{C}$	—	2.0	—	V	
Short circuit current limit	I_{SC}	1	$T_j = 25^\circ\text{C}$	—	1.6	—	A	
Average temperature coefficient of output voltage	T_{CVO}	1	$I_{OUT} = 5\text{ mA}$	—	-0.6	—	$\text{mV}/^\circ\text{C}$	

TA78057F

Electrical Characteristics

(Unless otherwise specified, $V_{IN} = 10.7\text{ V}$, $I_{OUT} = 500\text{ mA}$, $0^\circ\text{C} \leq T_j \leq 125^\circ\text{C}$)

Characteristics	Symbol	Test Circuit	Test Condition	Min	Typ.	Max	Unit	
Output voltage	V_{OUT}	1	$T_j = 25^\circ\text{C}$, $I_{OUT} = 100\text{ mA}$	5.47	5.7	5.93	V	
Line regulation	Reg-line	1	$T_j = 25^\circ\text{C}$	$7.7\text{ V} \leq V_{IN} \leq 25\text{ V}$	—	4	110	mV
				$8.7\text{ V} \leq V_{IN} \leq 12.7\text{ V}$	—	2	55	
Load regulation	Reg-load	1	$T_j = 25^\circ\text{C}$	$5\text{ mA} \leq I_{OUT} \leq 1.4\text{ A}$	—	15	110	mV
				$250\text{ mA} \leq I_{OUT} \leq 750\text{ mA}$	—	5	55	
Output voltage	V_{OUT}	1	$T_j = 25^\circ\text{C}$ $7.7\text{ V} \leq V_{IN} \leq 20.7\text{ V}$ $5.0\text{ mA} \leq I_{OUT} \leq 1.0\text{ A}$	5.42	—	5.98	V	
Quiescent current	I_B	1	$T_j = 25^\circ\text{C}$, $I_{OUT} = 5\text{ mA}$	—	4.3	8.0	mA	
Quiescent current change	ΔI_B	1	$7.7\text{ V} \leq V_{IN} \leq 25\text{ V}$, $I_{OUT} = 5\text{ mA}$, $T_j = 25^\circ\text{C}$	—	—	1.3	mA	
Output noise voltage	V_{NO}	2	$T_a = 25^\circ\text{C}$, $10\text{ Hz} \leq f \leq 100\text{ kHz}$ $I_{OUT} = 50\text{ mA}$	—	55	—	μV_{rms}	
Ripple rejection	R.R.	3	$f = 120\text{ Hz}$, $8.8\text{ V} \leq V_{IN} \leq 18.8\text{ V}$, $I_{OUT} = 50\text{ mA}$, $T_j = 25^\circ\text{C}$	56	72	—	dB	
Dropout voltage	V_D	1	$I_{OUT} = 1.0\text{ A}$, $T_j = 25^\circ\text{C}$	—	2.0	—	V	
Short circuit current limit	I_{SC}	1	$T_j = 25^\circ\text{C}$	—	1.5	—	A	
Average temperature coefficient of output voltage	T_{CVO}	1	$I_{OUT} = 5\text{ mA}$	—	-0.7	—	$\text{mV}/^\circ\text{C}$	

TA7806F

Electrical Characteristics

(Unless otherwise specified, $V_{IN} = 11\text{ V}$, $I_{OUT} = 500\text{ mA}$, $0^\circ\text{C} \leq T_j \leq 125^\circ\text{C}$)

Characteristics	Symbol	Test Circuit	Test Condition	Min	Typ.	Max	Unit	
Output voltage	V_{OUT}	1	$T_j = 25^\circ\text{C}$, $I_{OUT} = 100\text{ mA}$	5.75	6.0	6.25	V	
Line regulation	Reg-line	1	$T_j = 25^\circ\text{C}$	$8.0\text{ V} \leq V_{IN} \leq 25\text{ V}$	—	4	120	mV
				$9\text{ V} \leq V_{IN} \leq 13\text{ V}$	—	2	60	
Load regulation	Reg-load	1	$T_j = 25^\circ\text{C}$	$5\text{ mA} \leq I_{OUT} \leq 1.4\text{ A}$	—	15	120	mV
				$250\text{ mA} \leq I_{OUT} \leq 750\text{ mA}$	—	5	60	
Output voltage	V_{OUT}	1	$T_j = 25^\circ\text{C}$ $8\text{ V} \leq V_{IN} \leq 21\text{ V}$ $5.0\text{ mA} \leq I_{OUT} \leq 1.0\text{ A}$	5.7	—	6.3	V	
Quiescent current	I_B	1	$T_j = 25^\circ\text{C}$, $I_{OUT} = 5\text{ mA}$	—	4.3	8.0	mA	
Quiescent current change	ΔI_B	1	$8.0\text{ V} \leq V_{IN} \leq 25\text{ V}$, $I_{OUT} = 5\text{ mA}$, $T_j = 25^\circ\text{C}$	—	—	1.3	mA	
Output noise voltage	V_{NO}	2	$T_a = 25^\circ\text{C}$, $10\text{ Hz} \leq f \leq 100\text{ kHz}$ $I_{OUT} = 50\text{ mA}$	—	55	—	μV_{rms}	
Ripple rejection	R.R.	3	$f = 120\text{ Hz}$, $11\text{ V} \leq V_{IN} \leq 19\text{ V}$ $I_{OUT} = 50\text{ mA}$, $T_j = 25^\circ\text{C}$	56	72	—	dB	
Dropout voltage	V_D	1	$I_{OUT} = 1.0\text{ A}$, $T_j = 25^\circ\text{C}$	—	2.0	—	V	
Short circuit current limit	I_{SC}	1	$T_j = 25^\circ\text{C}$	—	1.5	—	A	
Average temperature coefficient of output voltage	T_{CVO}	1	$I_{OUT} = 5\text{ mA}$	—	-0.7	—	$\text{mV}/^\circ\text{C}$	

TA7807F

Electrical Characteristics

(Unless otherwise specified, $V_{IN} = 12\text{ V}$, $I_{OUT} = 500\text{ mA}$, $0^\circ\text{C} \leq T_j \leq 125^\circ\text{C}$)

Characteristics	Symbol	Test Circuit	Test Condition	Min	Typ.	Max	Unit	
Output voltage	V_{OUT}	1	$T_j = 25^\circ\text{C}$, $I_{OUT} = 100\text{ mA}$	6.72	7.0	7.28	V	
Line regulation	Reg-line	1	$T_j = 25^\circ\text{C}$	$9\text{ V} \leq V_{IN} \leq 25\text{ V}$	—	5	140	mV
				$10\text{ V} \leq V_{IN} \leq 14\text{ V}$	—	2	70	
Load regulation	Reg-load	1	$T_j = 25^\circ\text{C}$	$5\text{ mA} \leq I_{OUT} \leq 1.4\text{ A}$	—	15	140	mV
				$250\text{ mA} \leq I_{OUT} \leq 750\text{ mA}$	—	5	70	
Output voltage	V_{OUT}	1	$T_j = 25^\circ\text{C}$ $9\text{ V} \leq V_{IN} \leq 22\text{ V}$ $5.0\text{ mA} \leq I_{OUT} \leq 1.0\text{ A}$	6.65	—	7.35	V	
Quiescent current	I_B	1	$T_j = 25^\circ\text{C}$, $I_{OUT} = 5\text{ mA}$	—	4.3	8.0	mA	
Quiescent current change	ΔI_B	1	$9\text{ V} \leq V_{IN} \leq 25\text{ V}$, $I_{OUT} = 5\text{ mA}$, $T_j = 25^\circ\text{C}$	—	—	1.3	mA	
Output noise voltage	V_{NO}	2	$T_a = 25^\circ\text{C}$, $10\text{ Hz} \leq f \leq 100\text{ kHz}$ $I_{OUT} = 50\text{ mA}$	—	60	—	μV_{rms}	
Ripple rejection	R.R.	3	$f = 120\text{ Hz}$, $12\text{ V} \leq V_{IN} \leq 20\text{ V}$ $I_{OUT} = 50\text{ mA}$, $T_j = 25^\circ\text{C}$	54	70	—	dB	
Dropout voltage	V_D	1	$I_{OUT} = 1.0\text{ A}$, $T_j = 25^\circ\text{C}$	—	2.0	—	V	
Short circuit current limit	I_{SC}	1	$T_j = 25^\circ\text{C}$	—	1.3	—	A	
Average temperature coefficient of output voltage	T_{CVO}	1	$I_{OUT} = 5\text{ mA}$	—	-0.8	—	$\text{mV}/^\circ\text{C}$	

TA7808F

Electrical Characteristics

(Unless otherwise specified, $V_{IN} = 14\text{ V}$, $I_{OUT} = 500\text{ mA}$, $0^\circ\text{C} \leq T_j \leq 125^\circ\text{C}$)

Characteristics	Symbol	Test Circuit	Test Condition	Min	Typ.	Max	Unit	
Output voltage	V_{OUT}	1	$T_j = 25^\circ\text{C}$, $I_{OUT} = 100\text{ mA}$	7.7	8.0	8.3	V	
Line regulation	Reg-line	1	$T_j = 25^\circ\text{C}$	$10.5\text{ V} \leq V_{IN} \leq 25\text{ V}$	—	6	160	mV
				$11\text{ V} \leq V_{IN} \leq 17\text{ V}$	—	2	80	
Load regulation	Reg-load	1	$T_j = 25^\circ\text{C}$	$5\text{ mA} \leq I_{OUT} \leq 1.4\text{ A}$	—	12	160	mV
				$250\text{ mA} \leq I_{OUT} \leq 750\text{ mA}$	—	4	80	
Output voltage	V_{OUT}	1	$T_j = 25^\circ\text{C}$ $10.5\text{ V} \leq V_{IN} \leq 23\text{ V}$ $5.0\text{ mA} \leq I_{OUT} \leq 1.0\text{ A}$	7.6	—	8.4	V	
Quiescent current	I_B	1	$T_j = 25^\circ\text{C}$, $I_{OUT} = 5\text{ mA}$	—	4.3	8.0	mA	
Quiescent current change	ΔI_B	1	$10.5\text{ V} \leq V_{IN} \leq 25\text{ V}$, $I_{OUT} = 5\text{ mA}$, $T_j = 25^\circ\text{C}$	—	—	1.0	mA	
Output noise voltage	V_{NO}	2	$T_a = 25^\circ\text{C}$, $10\text{ Hz} \leq f \leq 100\text{ kHz}$ $I_{OUT} = 50\text{ mA}$	—	70	—	μV_{rms}	
Ripple rejection	R.R.	3	$f = 120\text{ Hz}$, $14\text{ V} \leq V_{IN} \leq 21.5\text{ V}$ $I_{OUT} = 50\text{ mA}$, $T_j = 25^\circ\text{C}$	53	69	—	dB	
Dropout voltage	V_D	1	$I_{OUT} = 1.0\text{ A}$, $T_j = 25^\circ\text{C}$	—	2.0	—	V	
Short circuit current limit	I_{SC}	1	$T_j = 25^\circ\text{C}$	—	1.1	—	A	
Average temperature coefficient of output voltage	T_{CVO}	1	$I_{OUT} = 5\text{ mA}$	—	-1.0	—	$\text{mV}/^\circ\text{C}$	

TA7809F

Electrical Characteristics

(Unless otherwise specified, $V_{IN} = 15\text{ V}$, $I_{OUT} = 500\text{ mA}$, $0^\circ\text{C} \leq T_j \leq 125^\circ\text{C}$)

Characteristics	Symbol	Test Circuit	Test Condition	Min	Typ.	Max	Unit	
Output voltage	V_{OUT}	1	$T_j = 25^\circ\text{C}$, $I_{OUT} = 100\text{ mA}$	8.64	9.0	9.36	V	
Line regulation	Reg-line	1	$T_j = 25^\circ\text{C}$	$11.5\text{ V} \leq V_{IN} \leq 26\text{ V}$	—	7.0	180	mV
				$13\text{ V} \leq V_{IN} \leq 19\text{ V}$	—	2.5	90	
Load regulation	Reg-load	1	$T_j = 25^\circ\text{C}$	$5\text{ mA} \leq I_{OUT} \leq 1.4\text{ A}$	—	12	180	mV
				$250\text{ mA} \leq I_{OUT} \leq 750\text{ mA}$	—	4	90	
Output voltage	V_{OUT}	1	$T_j = 25^\circ\text{C}$ $11.5\text{ V} \leq V_{IN} \leq 24\text{ V}$ $5.0\text{ mA} \leq I_{OUT} \leq 1.0\text{ A}$	8.55	—	9.45	V	
Quiescent current	I_B	1	$T_j = 25^\circ\text{C}$, $I_{OUT} = 5\text{ mA}$	—	4.3	8.0	mA	
Quiescent current change	ΔI_B	1	$11.5\text{ V} \leq V_{IN} \leq 26\text{ V}$, $I_{OUT} = 5\text{ mA}$, $T_j = 25^\circ\text{C}$	—	—	1.0	mA	
Output noise voltage	V_{NO}	2	$T_a = 25^\circ\text{C}$, $10\text{ Hz} \leq f \leq 100\text{ kHz}$ $I_{OUT} = 50\text{ mA}$	—	75	—	μV_{rms}	
Ripple rejection	R.R.	3	$f = 120\text{ Hz}$, $15\text{ V} \leq V_{IN} \leq 22.5\text{ V}$ $I_{OUT} = 50\text{ mA}$, $T_j = 25^\circ\text{C}$	51	67	—	dB	
Dropout voltage	V_D	1	$I_{OUT} = 1.0\text{ A}$, $T_j = 25^\circ\text{C}$	—	2.0	—	V	
Short circuit current limit	I_{SC}	1	$T_j = 25^\circ\text{C}$	—	1.0	—	A	
Average temperature coefficient of output voltage	T_{CVO}	1	$I_{OUT} = 5\text{ mA}$	—	-1.1	—	$\text{mV}/^\circ\text{C}$	

TA7810F

Electrical Characteristics

(Unless otherwise specified, $V_{IN} = 16\text{ V}$, $I_{OUT} = 500\text{ mA}$, $0^\circ\text{C} \leq T_j \leq 125^\circ\text{C}$)

Characteristics	Symbol	Test Circuit	Test Condition	Min	Typ.	Max	Unit	
Output voltage	V_{OUT}	1	$T_j = 25^\circ\text{C}$, $I_{OUT} = 100\text{ mA}$	9.6	10.0	10.4	V	
Line regulation	Reg-line	1	$T_j = 25^\circ\text{C}$	$12.5\text{ V} \leq V_{IN} \leq 27\text{ V}$	—	8	200	mV
				$14\text{ V} \leq V_{IN} \leq 20\text{ V}$	—	2.5	100	
Load regulation	Reg-load	1	$T_j = 25^\circ\text{C}$	$5\text{ mA} \leq I_{OUT} \leq 1.4\text{ A}$	—	12	200	mV
				$250\text{ mA} \leq I_{OUT} \leq 750\text{ mA}$	—	4	100	
Output voltage	V_{OUT}	1	$T_j = 25^\circ\text{C}$ $12.5\text{ V} \leq V_{IN} \leq 25\text{ V}$ $5.0\text{ mA} \leq I_{OUT} \leq 1.0\text{ A}$	9.5	—	10.5	V	
Quiescent current	I_B	1	$T_j = 25^\circ\text{C}$, $I_{OUT} = 5\text{ mA}$	—	4.3	8.0	mA	
Quiescent current change	ΔI_B	1	$12.5\text{ V} \leq V_{IN} \leq 27\text{ V}$, $I_{OUT} = 5\text{ mA}$, $T_j = 25^\circ\text{C}$	—	—	1.0	mA	
Output noise voltage	V_{NO}	2	$T_a = 25^\circ\text{C}$, $10\text{ Hz} \leq f \leq 100\text{ kHz}$ $I_{OUT} = 50\text{ mA}$	—	80	—	μV_{rms}	
Ripple rejection	R.R.	3	$f = 120\text{ Hz}$, $16\text{ V} \leq V_{IN} \leq 23.5\text{ V}$ $I_{OUT} = 50\text{ mA}$, $T_j = 25^\circ\text{C}$	50	66	—	dB	
Dropout voltage	V_D	1	$I_{OUT} = 1.0\text{ A}$, $T_j = 25^\circ\text{C}$	—	2.0	—	V	
Short circuit current limit	I_{SC}	1	$T_j = 25^\circ\text{C}$	—	0.9	—	A	
Average temperature coefficient of output voltage	T_{CVO}	1	$I_{OUT} = 5\text{ mA}$	—	-1.3	—	$\text{mV}/^\circ\text{C}$	

TA7812F

Electrical Characteristics

(Unless otherwise specified, $V_{IN} = 19\text{ V}$, $I_{OUT} = 500\text{ mA}$, $0^\circ\text{C} \leq T_j \leq 125^\circ\text{C}$)

Characteristics	Symbol	Test Circuit	Test Condition	Min	Typ.	Max	Unit	
Output voltage	V_{OUT}	1	$T_j = 25^\circ\text{C}$, $I_{OUT} = 100\text{ mA}$	11.5	12.0	12.5	V	
Line regulation	Reg-line	1	$T_j = 25^\circ\text{C}$	$14.5\text{ V} \leq V_{IN} \leq 30\text{ V}$	—	10	240	mV
				$16\text{ V} \leq V_{IN} \leq 22\text{ V}$	—	3	120	
Load regulation	Reg-load	1	$T_j = 25^\circ\text{C}$	$5\text{ mA} \leq I_{OUT} \leq 1.4\text{ A}$	—	12	240	mV
				$250\text{ mA} \leq I_{OUT} \leq 750\text{ mA}$	—	4	120	
Output voltage	V_{OUT}	1	$T_j = 25^\circ\text{C}$ $14.5\text{ V} \leq V_{IN} \leq 27\text{ V}$ $5.0\text{ mA} \leq I_{OUT} \leq 1.0\text{ A}$	11.4	—	12.6	V	
Quiescent current	I_B	1	$T_j = 25^\circ\text{C}$, $I_{OUT} = 5\text{ mA}$	—	4.3	8.0	mA	
Quiescent current change	ΔI_B	1	$14.5\text{ V} \leq V_{IN} \leq 30\text{ V}$, $I_{OUT} = 5\text{ mA}$, $T_j = 25^\circ\text{C}$	—	—	1.0	mA	
Output noise voltage	V_{NO}	2	$T_a = 25^\circ\text{C}$, $10\text{ Hz} \leq f \leq 100\text{ kHz}$ $I_{OUT} = 50\text{ mA}$	—	90	—	μV_{rms}	
Ripple rejection	R.R.	3	$f = 120\text{ Hz}$, $19\text{ V} \leq V_{IN} \leq 25\text{ V}$ $I_{OUT} = 50\text{ mA}$, $T_j = 25^\circ\text{C}$	50	66	—	dB	
Dropout voltage	V_D	1	$I_{OUT} = 1.0\text{ A}$, $T_j = 25^\circ\text{C}$	—	2.0	—	V	
Short circuit current limit	I_{SC}	1	$T_j = 25^\circ\text{C}$	—	0.7	—	A	
Average temperature coefficient of output voltage	T_{CVO}	1	$I_{OUT} = 5\text{ mA}$	—	-1.6	—	$\text{mV}/^\circ\text{C}$	

TA7815F

Electrical Characteristics

(Unless otherwise specified, $V_{IN} = 23\text{ V}$, $I_{OUT} = 500\text{ mA}$, $0^\circ\text{C} \leq T_j \leq 125^\circ\text{C}$)

Characteristics	Symbol	Test Circuit	Test Condition	Min	Typ.	Max	Unit	
Output voltage	V_{OUT}	1	$T_j = 25^\circ\text{C}$, $I_{OUT} = 100\text{ mA}$	14.4	15.0	15.6	V	
Line regulation	Reg-line	1	$T_j = 25^\circ\text{C}$	$17.5\text{ V} \leq V_{IN} \leq 30\text{ V}$	—	11	300	mV
				$20\text{ V} \leq V_{IN} \leq 26\text{ V}$	—	3	150	
Load regulation	Reg-load	1	$T_j = 25^\circ\text{C}$	$5\text{ mA} \leq I_{OUT} \leq 1.4\text{ A}$	—	12	300	mV
				$250\text{ mA} \leq I_{OUT} \leq 750\text{ mA}$	—	4	150	
Output voltage	V_{OUT}	1	$T_j = 25^\circ\text{C}$ $17.5\text{ V} \leq V_{IN} \leq 30\text{ V}$ $5.0\text{ mA} \leq I_{OUT} \leq 1.0\text{ A}$	14.25	—	15.75	V	
Quiescent current	I_B	1	$T_j = 25^\circ\text{C}$, $I_{OUT} = 5\text{ mA}$	—	4.4	8.0	mA	
Quiescent current change	ΔI_B	1	$17.5\text{ V} \leq V_{IN} \leq 30\text{ V}$, $I_{OUT} = 5\text{ mA}$, $T_j = 25^\circ\text{C}$	—	—	1.0	mA	
Output noise voltage	V_{NO}	2	$T_a = 25^\circ\text{C}$, $10\text{ Hz} \leq f \leq 100\text{ kHz}$ $I_{OUT} = 50\text{ mA}$	—	110	—	μV_{rms}	
Ripple rejection	R.R.	3	$f = 120\text{ Hz}$, $23\text{ V} \leq V_{IN} \leq 28.5\text{ V}$ $I_{OUT} = 50\text{ mA}$, $T_j = 25^\circ\text{C}$	49	65	—	dB	
Dropout voltage	V_D	1	$I_{OUT} = 1.0\text{ A}$, $T_j = 25^\circ\text{C}$	—	2.0	—	V	
Short circuit current limit	I_{SC}	1	$T_j = 25^\circ\text{C}$	—	0.5	—	A	
Average temperature coefficient of output voltage	T_{CVO}	1	$I_{OUT} = 5\text{ mA}$	—	-2.0	—	$\text{mV}/^\circ\text{C}$	

TA7818F

Electrical Characteristics

(Unless otherwise specified, $V_{IN} = 27\text{ V}$, $I_{OUT} = 500\text{ mA}$, $0^\circ\text{C} \leq T_j \leq 125^\circ\text{C}$)

Characteristics	Symbol	Test Circuit	Test Condition	Min	Typ.	Max	Unit	
Output voltage	V_{OUT}	1	$T_j = 25^\circ\text{C}$, $I_{OUT} = 100\text{ mA}$	17.3	18.0	18.7	V	
Line regulation	Reg-line	1	$T_j = 25^\circ\text{C}$	$21\text{ V} \leq V_{IN} \leq 33\text{ V}$	—	13	360	mV
				$24\text{ V} \leq V_{IN} \leq 30\text{ V}$	—	4	180	
Load regulation	Reg-load	1	$T_j = 25^\circ\text{C}$	$5\text{ mA} \leq I_{OUT} \leq 1.4\text{ A}$	—	12	360	mV
				$250\text{ mA} \leq I_{OUT} \leq 750\text{ mA}$	—	4	180	
Output voltage	V_{OUT}	1	$T_j = 25^\circ\text{C}$ $21\text{ V} \leq V_{IN} \leq 33\text{ V}$ $5.0\text{ mA} \leq I_{OUT} \leq 1.0\text{ A}$	17.1	—	18.9	V	
Quiescent current	I_B	1	$T_j = 25^\circ\text{C}$, $I_{OUT} = 5\text{ mA}$	—	4.5	8.0	mA	
Quiescent current change	ΔI_B	1	$21\text{ V} \leq V_{IN} \leq 33\text{ V}$, $I_{OUT} = 5\text{ mA}$, $T_j = 25^\circ\text{C}$	—	—	1.0	mA	
Output noise voltage	V_{NO}	2	$T_a = 25^\circ\text{C}$, $10\text{ Hz} \leq f \leq 100\text{ kHz}$ $I_{OUT} = 50\text{ mA}$	—	125	—	μV_{rms}	
Ripple rejection	R.R.	3	$f = 120\text{ Hz}$, $27\text{ V} \leq V_{IN} \leq 32\text{ V}$ $I_{OUT} = 50\text{ mA}$, $T_j = 25^\circ\text{C}$	47	63	—	dB	
Dropout voltage	V_D	1	$I_{OUT} = 1.0\text{ A}$, $T_j = 25^\circ\text{C}$	—	2.0	—	V	
Short circuit current limit	I_{SC}	1	$T_j = 25^\circ\text{C}$	—	0.4	—	A	
Average temperature coefficient of output voltage	T_{CVO}	1	$I_{OUT} = 5\text{ mA}$	—	-2.5	—	$\text{mV}/^\circ\text{C}$	

TA7820F

Electrical Characteristics

(Unless otherwise specified, $V_{IN} = 29\text{ V}$, $I_{OUT} = 500\text{ mA}$, $0^\circ\text{C} \leq T_j \leq 125^\circ\text{C}$)

Characteristics	Symbol	Test Circuit	Test Condition	Min	Typ.	Max	Unit	
Output voltage	V_{OUT}	1	$T_j = 25^\circ\text{C}$, $I_{OUT} = 100\text{ mA}$	19.2	20.0	20.8	V	
Line regulation	Reg-line	1	$T_j = 25^\circ\text{C}$	$23\text{ V} \leq V_{IN} \leq 35\text{ V}$	—	15	400	mV
				$26\text{ V} \leq V_{IN} \leq 32\text{ V}$	—	5	200	
Load regulation	Reg-load	1	$T_j = 25^\circ\text{C}$	$5\text{ mA} \leq I_{OUT} \leq 1.4\text{ A}$	—	12	400	mV
				$250\text{ mA} \leq I_{OUT} \leq 750\text{ mA}$	—	4	200	
Output voltage	V_{OUT}	1	$T_j = 25^\circ\text{C}$ $23\text{ V} \leq V_{IN} \leq 35\text{ V}$ $5.0\text{ mA} \leq I_{OUT} \leq 1.0\text{ A}$	19.0	—	21.0	V	
Quiescent current	I_B	1	$T_j = 25^\circ\text{C}$, $I_{OUT} = 5\text{ mA}$	—	4.6	8.0	mA	
Quiescent current change	ΔI_B	1	$23\text{ V} \leq V_{IN} \leq 35\text{ V}$, $I_{OUT} = 5\text{ mA}$, $T_j = 25^\circ\text{C}$	—	—	1.0	mA	
Output noise voltage	V_{NO}	2	$T_a = 25^\circ\text{C}$, $10\text{ Hz} \leq f \leq 100\text{ kHz}$ $I_{OUT} = 50\text{ mA}$	—	135	—	μV_{rms}	
Ripple rejection	R.R.	3	$f = 120\text{ Hz}$, $29\text{ V} \leq V_{IN} \leq 34\text{ V}$ $I_{OUT} = 50\text{ mA}$, $T_j = 25^\circ\text{C}$	45	61	—	dB	
Dropout voltage	V_D	1	$I_{OUT} = 1.0\text{ A}$, $T_j = 25^\circ\text{C}$	—	2.0	—	V	
Short circuit current limit	I_{SC}	1	$T_j = 25^\circ\text{C}$	—	0.4	—	A	
Average temperature coefficient of output voltage	T_{CVO}	1	$I_{OUT} = 5\text{ mA}$	—	-3.0	—	$\text{mV}/^\circ\text{C}$	

TA7824F

Electrical Characteristics

(Unless otherwise specified, $V_{IN} = 33\text{ V}$, $I_{OUT} = 500\text{ mA}$, $0^\circ\text{C} \leq T_j \leq 125^\circ\text{C}$)

Characteristics	Symbol	Test Circuit	Test Condition	Min	Typ.	Max	Unit	
Output voltage	V_{OUT}	1	$T_j = 25^\circ\text{C}$, $I_{OUT} = 100\text{ mA}$	23.0	24.0	25.0	V	
Line regulation	Reg-line	1	$T_j = 25^\circ\text{C}$	$27\text{ V} \leq V_{IN} \leq 38\text{ V}$	—	18	480	mV
				$30\text{ V} \leq V_{IN} \leq 36\text{ V}$	—	6	240	
Load regulation	Reg-load	1	$T_j = 25^\circ\text{C}$	$5\text{ mA} \leq I_{OUT} \leq 1.4\text{ A}$	—	12	480	mV
				$250\text{ mA} \leq I_{OUT} \leq 750\text{ mA}$	—	4	240	
Output voltage	V_{OUT}	1	$T_j = 25^\circ\text{C}$ $27\text{ V} \leq V_{IN} \leq 38\text{ V}$ $5.0\text{ mA} \leq I_{OUT} \leq 1.0\text{ A}$	22.8	—	25.2	V	
Quiescent current	I_B	1	$T_j = 25^\circ\text{C}$, $I_{OUT} = 5\text{ mA}$	—	4.6	8.0	mA	
Quiescent current change	ΔI_B	1	$27\text{ V} \leq V_{IN} \leq 38\text{ V}$, $I_{OUT} = 5\text{ mA}$, $T_j = 25^\circ\text{C}$	—	—	1.0	mA	
Output noise voltage	V_{NO}	2	$T_a = 25^\circ\text{C}$, $10\text{ Hz} \leq f \leq 100\text{ kHz}$ $I_{OUT} = 50\text{ mA}$	—	150	—	μV_{rms}	
Ripple rejection	R.R.	3	$f = 120\text{ Hz}$, $33\text{ V} \leq V_{IN} \leq 38\text{ V}$ $I_{OUT} = 50\text{ mA}$, $T_j = 25^\circ\text{C}$	45	61	—	dB	
Dropout voltage	V_D	1	$I_{OUT} = 1.0\text{ A}$, $T_j = 25^\circ\text{C}$	—	2.0	—	V	
Short circuit current limit	I_{SC}	1	$T_j = 25^\circ\text{C}$	—	0.3	—	A	
Average temperature coefficient of output voltage	T_{CVO}	1	$I_{OUT} = 5\text{ mA}$	—	-3.5	—	$\text{mV}/^\circ\text{C}$	

Test Circuit 1/Standard Application Circuit

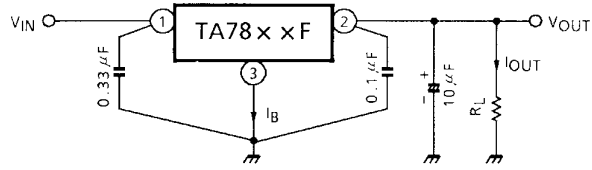

Test Circuit 2

V_{NO}

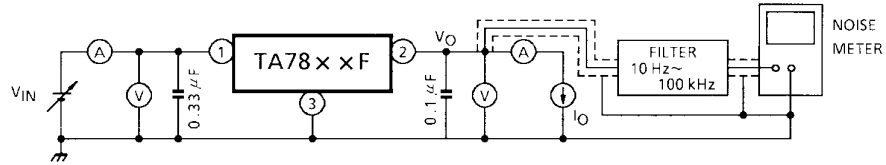

Test Circuit 3

R.R.

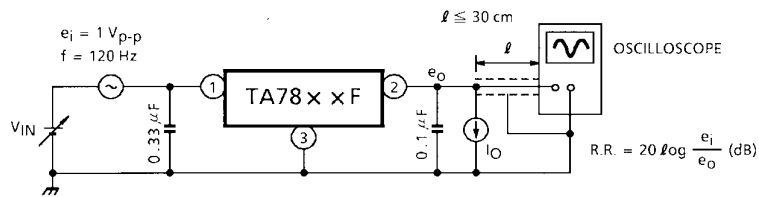

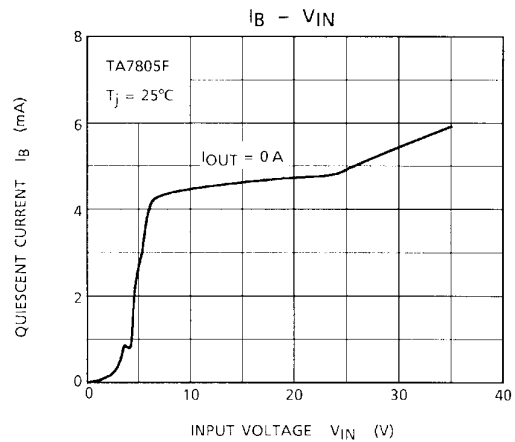
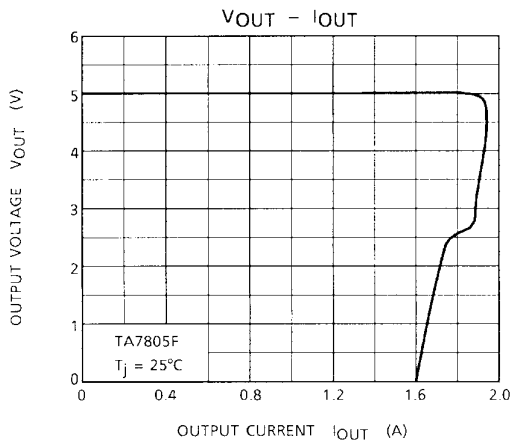
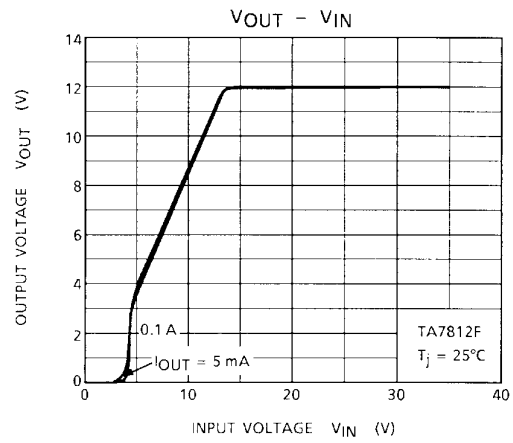
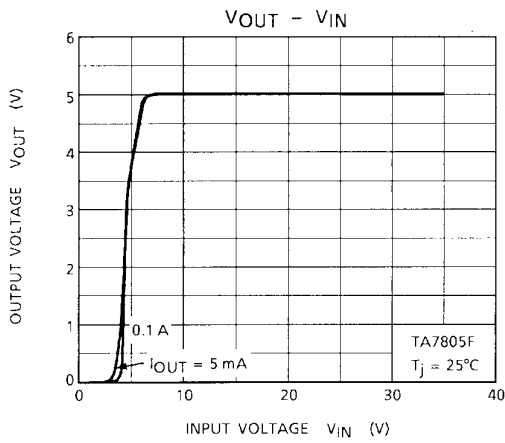
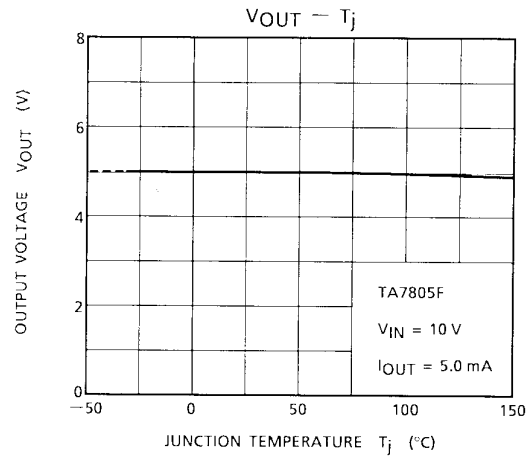
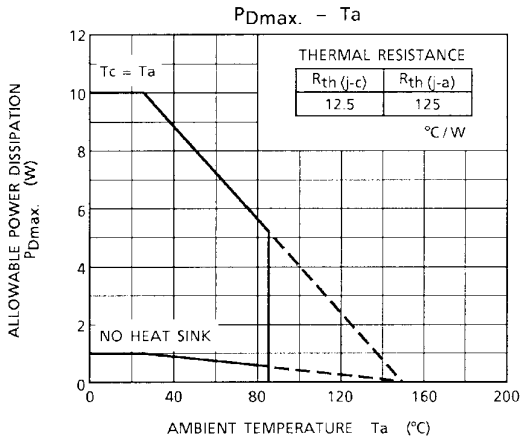

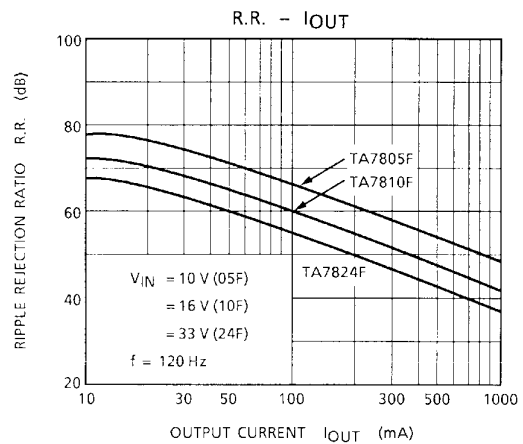
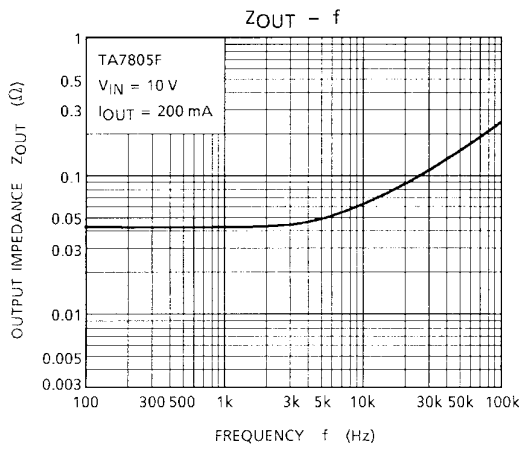
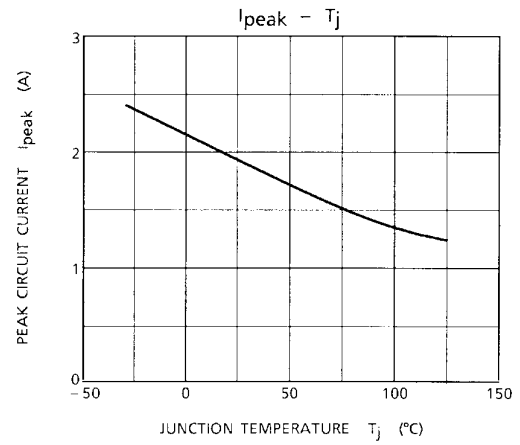
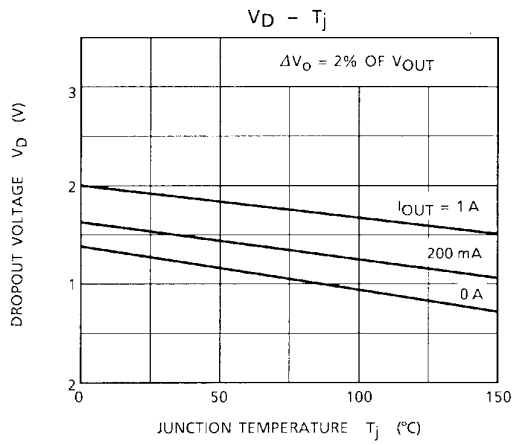
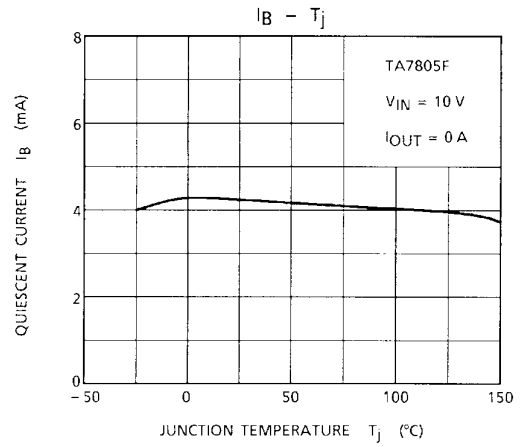
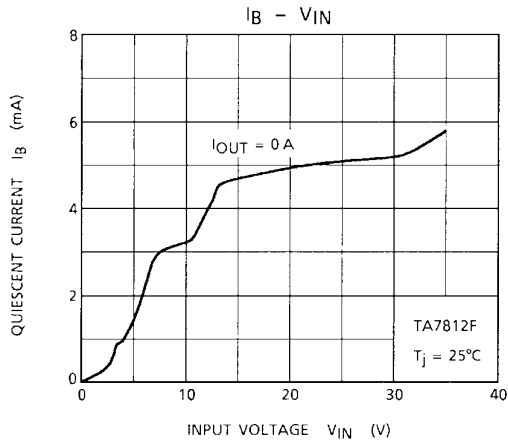

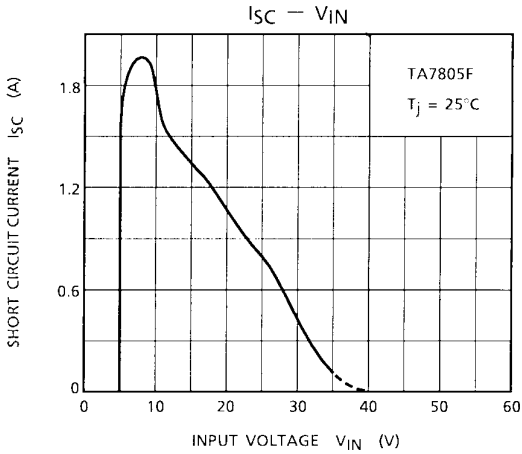

Precautions on Application

- (1) In regard to GND, be careful not to apply a negative voltage to the input/output terminal. Further, special care is necessary in case of a voltage boost application.
- (2) When a surge voltage exceeding maximum rating is applied to the input terminal or when a voltage in excess of the input terminal voltage is applied to the output terminal, the circuit may be destroyed. Specially, in the latter case, great care is necessary.
Further, if the input terminal shorts to GND in a state of normal operation, the output terminal voltage becomes higher than the input voltage (GND potential), and the electric charge of a chemical capacitor connected to the output terminal flows into the input side, which may cause the destruction of circuit.
In these cases, take such steps as a zener diode and a general silicon diode are connected to the circuit, as shown in the following figure.

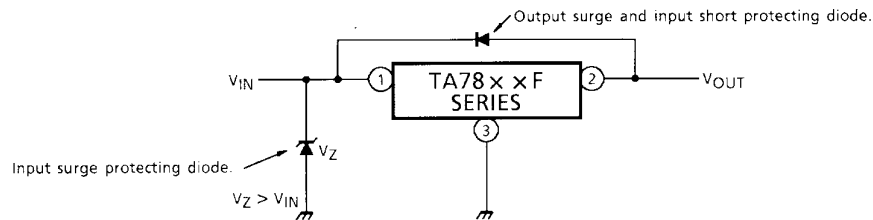

- (3) When the input voltage is too high, the power dissipation of three terminal regulator increases because of series regulator, so that the junction temperature rises. In such a case, it is recommended to reduce the power dissipation by inserting the power limiting resistor R_{SD} in the input terminal, and to reduce the junction temperature as a result.

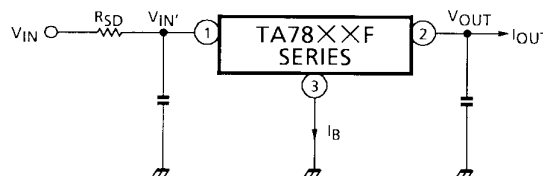

The power dissipation P_D of IC is expressed in the following equation.

$$P_D = (V_{IN'} - V_{OUT}) \cdot I_{OUT} + V_{IN'} \cdot I_B$$

If $V_{IN'}$ is reduced below the lowest voltage necessary for the IC, the parasitic oscillation will be caused according to circumstances.

In determining the resistance value of R_{SD} , design with margin should be made by making reference to the following equation.

$$R_{SD} < \frac{V_{IN} - V_{IN'}}{I_{OUT} + I_B}$$

- (4) Connect the input terminal and GND, and the output terminal and GND, by capacitor respectively. The capacitances should be determined experimentally because they depend on PCB patterns. In particular, adequate investigation should be made so that there is no problem even at time of high or low temperature.

- (5) The molded plastic portion of this unit, measuring 5.5 mm (L) by 6.8 mm (W) by 2.5 mm (T), is more compact compared to its equivalents TO-220. The GND fin extends directly out of the main body, and can be soldered directly to the ceramic circuit board, to significantly increase the power dissipation. For obtaining high reliability on the heat sink design of the regulator IC, it is generally required to derate more than 20% of maximum junction temperature ($T_j \text{ max}$). Further, full consideration should be given to the installation of IC to the heat sink.

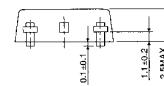
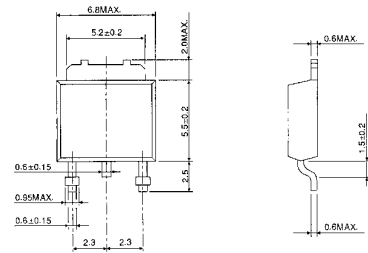

Application Circuits

(1) Voltage boost regulator

- (a) Voltage boost by use of zener diode

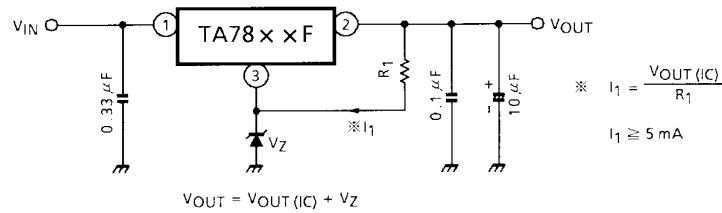

- (b) Voltage boost by use of resistor

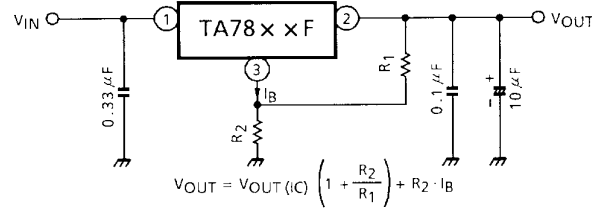

- (c) Adjustable output regulator

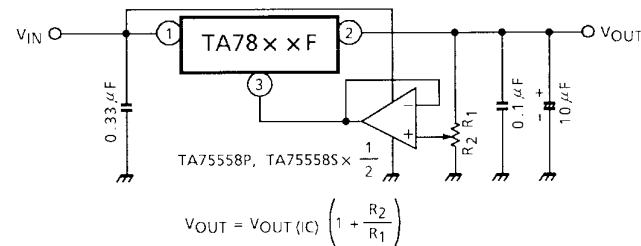

(2) Current boost regulator

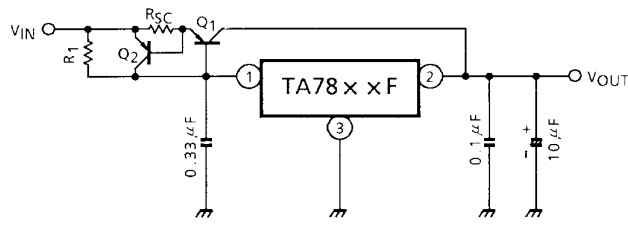

Heat sink is needed for Q₁.

$$R_1 \cong \frac{V_{BE1}}{I_B \text{ MAX}}$$

where,

V_{BE1} : V_{BE} of external transistor Q₁.
 I_B MAX : Quiescent current of IC.

$$R_{SC} = \frac{V_{BE2}}{I_{SC}}$$

where,

I_{SC} : Short-circuit current.

Package Dimensions

HSIP3-P-2.30B

Unit : mm

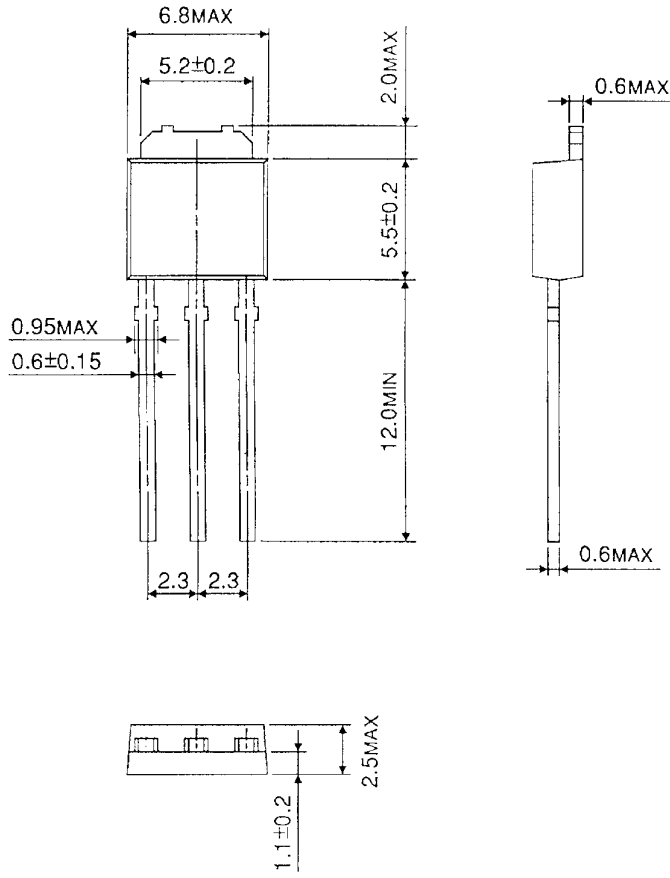

Weight : 0.36 g (Typ.)

Package Dimensions

HSOP3-P-2.30A

Unit : mm

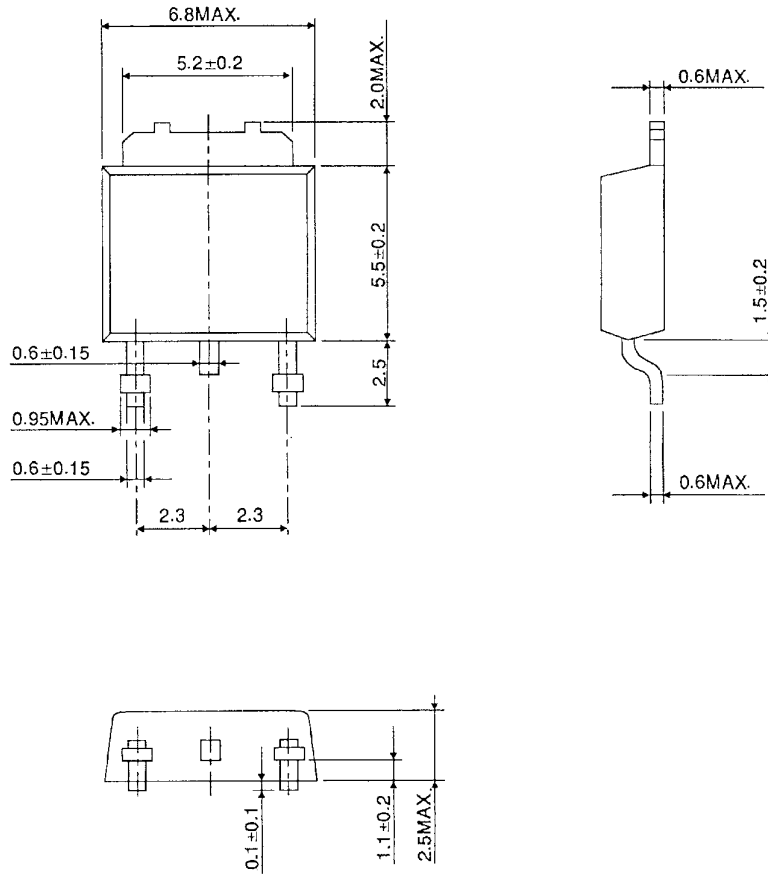

Weight : 0.36 g (Typ.)

RESTRICTIONS ON PRODUCT USE

000707EBA

- TOSHIBA is continually working to improve the quality and reliability of its products. Nevertheless, semiconductor devices in general can malfunction or fail due to their inherent electrical sensitivity and vulnerability to physical stress. It is the responsibility of the buyer, when utilizing TOSHIBA products, to comply with the standards of safety in making a safe design for the entire system, and to avoid situations in which a malfunction or failure of such TOSHIBA products could cause loss of human life, bodily injury or damage to property.
In developing your designs, please ensure that TOSHIBA products are used within specified operating ranges as set forth in the most recent TOSHIBA products specifications. Also, please keep in mind the precautions and conditions set forth in the "Handling Guide for Semiconductor Devices," or "TOSHIBA Semiconductor Reliability Handbook" etc..
- The TOSHIBA products listed in this document are intended for usage in general electronics applications (computer, personal equipment, office equipment, measuring equipment, industrial robotics, domestic appliances, etc.). These TOSHIBA products are neither intended nor warranted for usage in equipment that requires extraordinarily high quality and/or reliability or a malfunction or failure of which may cause loss of human life or bodily injury ("Unintended Usage"). Unintended Usage include atomic energy control instruments, airplane or spaceship instruments, transportation instruments, traffic signal instruments, combustion control instruments, medical instruments, all types of safety devices, etc.. Unintended Usage of TOSHIBA products listed in this document shall be made at the customer's own risk.
- The products described in this document are subject to the foreign exchange and foreign trade laws.
- The information contained herein is presented only as a guide for the applications of our products. No responsibility is assumed by TOSHIBA CORPORATION for any infringements of intellectual property or other rights of the third parties which may result from its use. No license is granted by implication or otherwise under any intellectual property or other rights of TOSHIBA CORPORATION or others.
- The information contained herein is subject to change without notice.