

Contents

Features.....	1
Applications	1
Pin Assignment.....	1
Block Diagram	2
Selection Guide	3
Output Configurations.....	4
Advantage over the S-805 Series.....	5
Absolute Maximum Ratings.....	6
Electrical Characteristics	7
Test Circuits.....	23
Technical Terms	24
Operation	26
Dimensions	28
Taping.....	29
Magazine Dimensions	31
Markings	32
Characteristics	33
Measuring Circuits	36
Application Circuit Examples	37
Notes	39
Frequently Asked Questions.....	40

HIGH-PRECISION VOLTAGE DETECTOR

S-807 Series

The S-807 Series is an adjustment-free high-precision voltage detector made using the CMOS process. The output voltage is fixed internally, with an accuracy of $\pm 2.4\%$. Two output types are available, Nch open-drain and CMOS output (active "H" and "L"), both of which have various product lineups. This series features much lower current consumption and higher detection voltage accuracy than the S-805 Series. Super-miniature package is added for the S-807 Series, the S-807XXSX Series. This small SOT-23-5 style package allows the designer to shrink the size of his finished product. Electrical specs for the S-807XXSX Series are the same as the standard S-807 Series. Output forms of the S-807XXSX Series are Nch open-drain and CMOS active "L".

■ Features

- Ultra-low current consumption
1.0 μA typ. ($V_{\text{DD}}=4.5\text{ V}$)
- High-precision detection voltage $\pm 2.4\%$
- Wide operating voltage range 1.0 to 15 V
- Good hysteresis characteristics 5% typ.
- Wide operating temperature range -30°C to $+80^\circ\text{C}$
- 3 output forms : Nch open-drain, CMOS output active H , active L
- TO-92, SOT-89-3 and SOT-23-5 package

■ Applications

- Battery checker
- Battery backup for memories
- Power failure detector
- Reset for microcomputer
- Store signal detector for non-volatile RAM

■ Pin Assignment

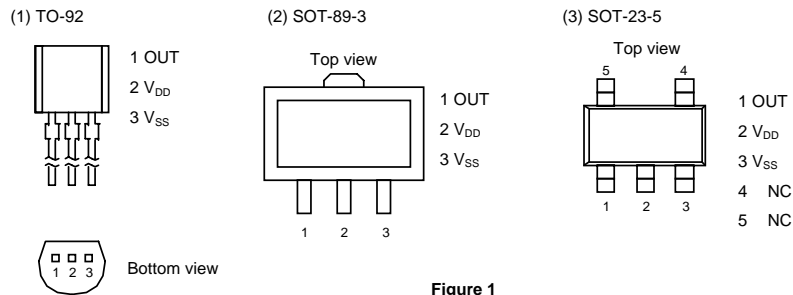

Figure 1

HIGH-PRECISION VOLTAGE DETECTOR

S-807 Series

■ Block Diagram

(1) Nch open-drain output

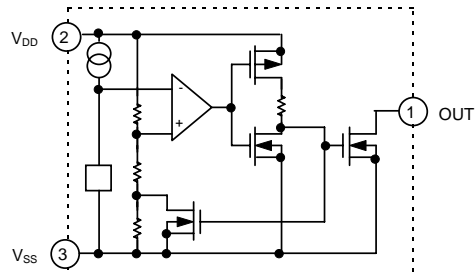

(2) CMOS active low output

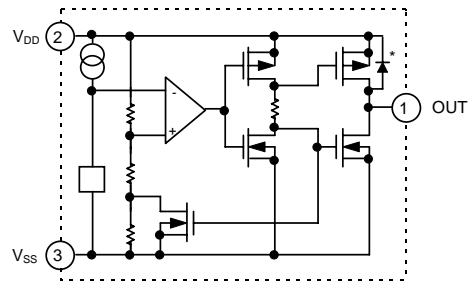

(3) CMOS active high output

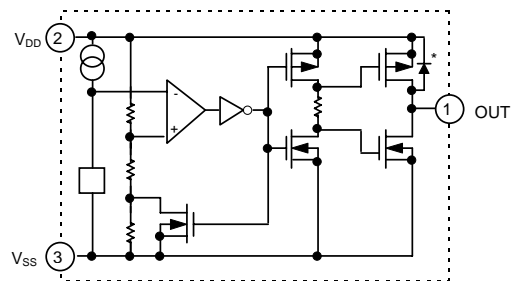

* Parasitic diode

Figure 2

HIGH-PRECISION VOLTAGE DETECTOR

S-807 Series

■ Selection Guide

Table 1

Detection voltage range (V)	Hysteresis width typ. (V)	CMOS output (Low)			CMOS output (High)		Nch open-drain		
		TO-92	SOT-89-3*	SOT-23-5*	TO-92	SOT-89-3*	TO-92	SOT-89-3*	SOT-23-5*
1.5 V±2.4%	0.075		S-80715AL-AC-X				S-80715AN-DC-X		
1.6 V±2.4%	0.08		S-80716AL-AD-X			S-80716AN	S-80716AN-DD-X		
1.7 V±2.4%	0.085	S-80717AL	S-80717AL-AE-X			S-80717AN	S-80717AN-DE-X	S-80717SN-DE-X	
1.8 V±2.4%	0.09	S-80718AL	S-80718AL-AF-X	S-80718SL-AF-X		S-80718AH-BF-T1	S-80718AN	S-80718AN-DF-X	
1.9 V±2.4%	0.095	S-80719AL	S-80719AL-AG-X	S-80719SL-AG-X			S-80719AN	S-80719AN-DG-X	S-80719SN-DG-X
2.0 V±2.4%	0.1		S-80720AL-AH-X	S-80720SL-AH-X			S-80720AN	S-80720AN-DH-X	S-80720SN-DH-X
2.1 V±2.4%	0.105	S-80721AL	S-80721AL-AJ-X	S-80721SL-AJ-X			S-80721AN	S-80721AN-DJ-X	S-80721SN-DJ-X
2.2 V±2.4%	0.11	S-80722AL	S-80722AL-AK-X				S-80722AN	S-80722AN-DK-X	
2.3 V±2.4%	0.115	S-80723AL	S-80723AL-AL-X	S-80723SL-AL-X			S-80723AN	S-80723AN-DL-X	S-80723SN-DL-X
2.4 V±2.4%	0.12	S-80724AL	S-80724AL-AM-X				S-80724AN	S-80724AN-DM-X	S-80724SN-DM-X
2.5 V±2.4%	0.125	S-80725AL	S-80725AL-AN-X	S-80725SL-AN-X		S-80725AH-BN-X	S-80725AN	S-80725AN-DN-X	S-80725SN-DN-X
2.6 V±2.4%	0.13		S-80726AL-AP-X				S-80726AN	S-80726AN-DP-X	
2.7 V±2.4%	0.135	S-80727AL	S-80727AL-AQ-X	S-80727SL-AQ-X			S-80727AN	S-80727AN-DQ-X	S-80727SN-DQ-X
2.8 V±2.4%	0.14		S-80728AL-AR-X	S-80728SL-AR-X			S-80728AN	S-80728AN-DR-X	S-80728SN-DR-X
2.9 V±2.4%	0.145	S-80729AL	S-80729AL-AS-X					S-80729AN-DS-X	
3.0 V±2.4%	0.15	S-80730AL	S-80730AL-AT-X	S-80730SL-AT-X			S-80730AN	S-80730AN-DT-X	S-80730SN-DT-X
3.1 V±2.4%	0.155	S-80731AL	S-80731AL-AV-X		S-80731AH	S-80731AH-BV-X	S-80731AN	S-80731AN-DV-X	
3.2 V±2.4%	0.16	S-80732AL	S-80732AL-AW-X	S-80732SL-AW-X			S-80732AN	S-80732AN-DW-X	
3.3 V±2.4%	0.165	S-80733AL	S-80733AL-AX-X	S-80733SL-AX-X	S-80733AH		S-80733AN	S-80733AN-DX-X	S-80733SN-DX-X
3.4 V±2.4%	0.17	S-80734AL	S-80734AL-AY-X				S-80734AN	S-80734AN-DY-X	
3.5 V±2.4%	0.175	S-80735AL	S-80735AL-AZ-X	S-80735SL-AZ-X			S-80735AN	S-80735AN-DZ-X	S-80735SN-DZ-X
3.6V±2.4%	0.18		S-80736AL-A0-X				S-80736AN	S-80736AN-D0-X	
3.7V±2.4%	0.185	S-80737AL	S-80737AL-A1-X				S-80737AN	S-80737AN-D1-X	
3.8 V±2.4%	0.19	S-80738AL	S-80738AL-A2-X				S-80738AN	S-80738AN-D2-X	
3.9 V±2.4%	0.195	S-80739AL	S-80739AL-A3-X				S-80739AN	S-80739AN-D3-X	
4.0 V±2.4%	0.2	S-80740AL	S-80740AL-A4-X	S-80740SL-A4-X	S-80740AH	S-80740AH-B4-X	S-80740AN	S-80740AN-D4-X	S-80740SN-D4-X
4.1 V±2.4%	0.205	S-80741AL	S-80741AL-A5-X				S-80741AN	S-80741AN-D5-X	
4.2 V±2.4%	0.21	S-80742AL	S-80742AL-A6-X	S-80742SL-A6-X			S-80742AN	S-80742AN-D6-X	S-80742SN-D6-X
4.3 V±2.4%	0.215	S-80743AL	S-80743AL-A7-X				S-80743AN	S-80743AN-D7-X	
4.4 V±2.4%	0.22	S-80744AL	S-80744AL-A8-X				S-80744AN	S-80744AN-D8-X	S-80744SN-D8-X
4.295 to 4.605	Release voltage 4.70 max.	S-80744HL	S-80744HL-U8-X						
4.5 V±2.4%	0.225	S-80745AL	S-80745AL-A9-X	S-80745SL-A9-X		S-80745AH-B9-X	S-80745AN	S-80745AN-D9-X	S-80745SN-D9-X
4.6 V±2.4%	0.23	S-80746AL	S-80746AL-EA-X					S-80746AN-JA-X	
4.7 V±2.4%	0.235	S-80747AL	S-80747AL-EB-X					S-80747AN-JB-X	
4.8 V±2.4%	0.24		S-80748AL-EC-X				S-80748AN	S-80748AN-JC-X	
4.9 V±2.4%	0.245		S-80749AL-ED-X					S-80749AN-JD-X	
5.0 V±2.4%	0.25		S-80750AL-EE-X	S-80750SL-EE-X			S-80750AN	S-80750AN-JE-X	S-80750SN-JE-X
5.1 V±2.4%	0.255	S-80751AL		S-80751SL-EF-X			S-80751AN	S-80751AN-JF-X	S-80751SN-JF-X
5.2 V±2.4%	0.26		S-80752AL-EG-T1	S-80752SL-EG-T1				S-80752AN-JG-T1	
5.3 V±2.4%	0.265						S-80753AN		
5.5 V±2.4%	0.275		S-80755AL-EK-X						
6.1 V±2.4%	0.305			S-80761SL-ER-X					
6.3 V±2.4%	0.315							S-80763AN-JT-X	
7.7V±2.4%	0.385								S-80777SN-J8-X

* The last digit of the model name changes depending upon the packing form when it is an SOT package product (S-807XXSX Series is packed on tape).

S : Stick

T : Tape (T1 and T2 types are available depending on the direction of detectors on the tape.)

** Please ask our sales person if you need another detection voltage product.

HIGH-PRECISION VOLTAGE DETECTOR

S-807 Series

Output Configurations

1. S-807 Series model numbering conventions

	Nch open-drain ("L" reset type)	CMOS output ("L" reset type)	CMOS output ("H" reset type)
S-807 Series	"N" is the last letter of the model number. Ex. S-80732AN	"L" is the last letter of the model number. Ex. S-80718AL	"H" is the last letter of the model number. Ex. S-80740AH

2. Output configurations and their implementations

Implementation	Nch	CMOS ("L")	CMOS ("H")
With different power supplies	○	×	×
With active low reset CPUs	○	○	×
With active high reset CPUs	×	×	○
As power resets employing CR circuits	○	×	×
With voltage divider resistors to vary ($-V_{DET}$)	○	×	×

• Example with two power supplies

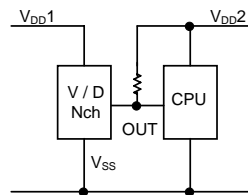

• Examples with one power supply

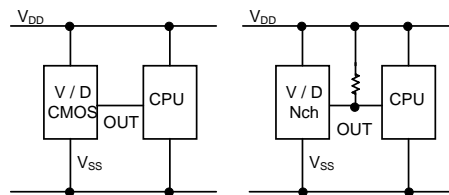

or

Figure 3

■ Advantage over the S-805 Series

The S-807 Series, in comparison with conventional reset ICs such as the S-805 Series, offers greater detection voltage precision (twice that of conventional units) and lower current consumption (half that of conventional units). These characteristics result in the following advantages over conventional units.

1. Advantages of greater detection voltage precision

1.1 Detecting lithium battery service life

The discharge characteristics of lithium batteries are shown in Figure 4. When using the S-805 Series, the service life can be detected over t_1 . When using the S-807 Series, it can be detected over t_2 . This improvement in detection precision of the S-807 Series means that batteries can be used over more of their service life.

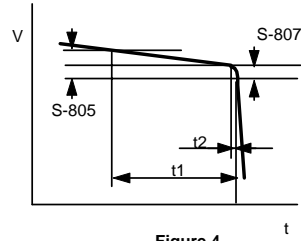

Figure 4

1.2 Detecting a power voltage at two points

It is usual for the CPU to detect the power voltage at two points, one to caution and the other to reset. The service life of battery may also be detected at two points, one to caution and the other to request immediate replacement.

Two voltage values to be detected (No. 1 and No. 2) do not cross and the voltage can be detected correctly.

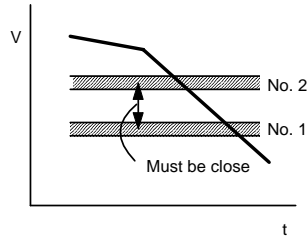

Figure 5

1.3 Voltage drop when modifying detection voltage

If no voltage to be detected is suitable, the voltage can be set higher in Nch open-drain output products by using a resistor divider. (Example : when detecting 6V or 9V.)

When 8V is detected using the S-8054HN (a $4V \pm 5\%$ device), the $-V_{det}$ tolerance becomes $2 \times 4.00 \times \pm 0.05 = 0.8V$ ($R_1=R_2$). In contrast, the S-80740AN (a $4V \pm 2.4\%$ device) can hold down the tolerance to $2 \times 4.00 \times \pm 0.024 = 0.384V$ ($R_1=R_2$).

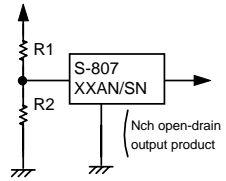

Figure 6

HIGH-PRECISION VOLTAGE DETECTOR S-807 Series

1.4 Operating margins of power and minimum operating voltage of CPU are close

Set the voltage so that it will be detected between the power voltage and the minimum operating voltage of the CPU. Thus, if two voltage points to be detected are very close, the voltage between those two points must be detected correctly. The S-807 Series offers an excellent detection voltage precision, so the voltage between narrow limits can be detected correctly.

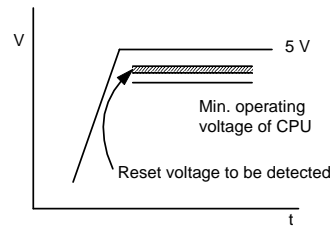

Figure 7

2. Others

2.1 Low current consumption

The current consumption is half of that of a conventional voltage detection IC, so the battery service life can be prolonged.

2.2 Wide operating voltage range

The maximum operating voltage of a conventional IC is 10 V. For the S-807 Series, the maximum detectable voltage has been increased to 15 V.

■ Absolute Maximum Ratings

Caution : Keep static electricity to a minimum. (Unless otherwise specified : Ta=25°C)

Parameter	Symbol	Ratings	Unit	
Power supply voltage	$V_{DD}-V_{SS}$	18	V	
Input voltage	V_{IN}	$V_{SS}-0.3$ to $V_{DD}+0.3$		
Output voltage	V_{OUT}	$V_{SS}-0.3$ to 18		
		CMOS	$V_{SS}-0.3$ to $V_{IN}+0.3$	
Output current	I_{OUT}	50	mA	
Power dissipation	P_D	TO-92, SOT-89-3	200	mW
		SOT-23-5	150	
Operating temperature	T_{opr}	-30 to +80	°C	
Storage temperature	T_{stg}	-40 to +125		

■ **Electrical Characteristics**

1. S-80715AL-AC-X, S-80715AN-DC-X (Detection voltage : 1.464 to 1.536 V)

(Unless otherwise specified : Ta=25°C)

Parameter	Symbol	Conditions	Min.	Typ.	Max.	Unit	Test circuit
Detection voltage	$-V_{DET}$		1.464	1.500	1.536	V	1
Hysteresis width	V_{HYS}		$-V_{DET} \times 0.02$	$-V_{DET} \times 0.05$	$-V_{DET} \times 0.08$	V	1
Current consumption	I_{SS}	$V_{DD} = 3.0\text{ V}$	—	1.4	3.5	μA	2
Operating voltage	V_{DD}		1.0	—	15.0	V	1
Output current	I_{OUT}	Nch $V_{DS} = 0.5\text{ V}$ $V_{DD} = 1.2\text{ V}$	0.23	0.50	—	mA	3
		Pch (CMOS output) $V_{DS} = 0.5\text{ V}$ $V_{DD} = 4.8\text{ V}$	0.36	0.62	—		4
Temperature characteristic of $-V_{DET}$	$\frac{\Delta -V_{DET}}{\Delta T_a}$	Ta=-30°C to 80°C	—	± 0.19	—	mV/°C	—

2. S-80716AL-AD-X, S-80716AN/AN-DD-X (Detection voltage : 1.561 to 1.639 V)

(Unless otherwise specified : Ta=25°C)

Parameter	Symbol	Conditions	Min.	Typ.	Max.	Unit	Test circuit
Detection voltage	$-V_{DET}$		1.561	1.600	1.639	V	1
Hysteresis width	V_{HYS}		$-V_{DET} \times 0.02$	$-V_{DET} \times 0.05$	$-V_{DET} \times 0.08$	V	1
Current consumption	I_{SS}	$V_{DD} = 3.0\text{ V}$	—	1.4	3.5	μA	2
Operating voltage	V_{DD}		1.0	—	15.0	V	1
Output current	I_{OUT}	Nch $V_{DS} = 0.5\text{ V}$ $V_{DD} = 1.2\text{ V}$	0.23	0.50	—	mA	3
		Pch (CMOS output) $V_{DS} = 0.5\text{ V}$ $V_{DD} = 4.8\text{ V}$	0.36	0.62	—		4
Temperature characteristic of $-V_{DET}$	$\frac{\Delta -V_{DET}}{\Delta T_a}$	Ta=-30°C to 80°C	—	± 0.20	—	mV/°C	—

3. S-80717AL/AL-AE-X, S-80717AN/AN-DE-X, S-80717SN-DE-X (Detection voltage : 1.659 to 1.741 V)

(Unless otherwise specified : Ta=25°C)

Parameter	Symbol	Conditions	Min.	Typ.	Max.	Unit	Test circuit
Detection voltage	$-V_{DET}$		1.659	1.700	1.741	V	1
Hysteresis width	V_{HYS}		$-V_{DET} \times 0.02$	$-V_{DET} \times 0.05$	$-V_{DET} \times 0.08$	V	1
Current consumption	I_{SS}	$V_{DD} = 3.0\text{ V}$	—	1.4	3.5	μA	2
Operating voltage	V_{DD}		1.0	—	15.0	V	1
Output current	I_{OUT}	Nch $V_{DS} = 0.5\text{ V}$ $V_{DD} = 1.2\text{ V}$	0.23	0.50	—	mA	3
		Pch (CMOS output) $V_{DS} = 0.5\text{ V}$ $V_{DD} = 4.8\text{ V}$	0.36	0.62	—		4
Temperature characteristic of $-V_{DET}$	$\frac{\Delta -V_{DET}}{\Delta T_a}$	Ta=-30°C to 80°C	—	± 0.21	—	mV/°C	—

HIGH-PRECISION VOLTAGE DETECTOR

S-807 Series

4. S-80718AL/AL-AF-X, S-80718AN/AN-DF-X, S-80718SL-AF-X (Detection voltage : 1.756 to 1.844 V)

(Unless otherwise specified : Ta=25°C)

Parameter	Symbol	Conditions	Min.	Typ.	Max.	Unit	Test circuit	
Detection voltage	$-V_{DET}$		1.756	1.800	1.844	V	1	
Hysteresis width	V_{HYS}		$-V_{DET} \times 0.02$	$-V_{DET} \times 0.05$	$-V_{DET} \times 0.08$	V	1	
Current consumption	I_{SS}	$V_{DD} = 3.0 \text{ V}$	—	1.4	3.5	μA	2	
Operating voltage	V_{DD}		1.0	—	15.0	V	1	
Output current	I_{OUT}	Nch $V_{DS} = 0.5 \text{ V}$	$V_{DD} = 1.2 \text{ V}$	0.23	0.50	—	mA	3
		Pch (CMOS output) $V_{DS} = 0.5 \text{ V}$	$V_{DD} = 4.8 \text{ V}$	0.36	0.62	—		4
Temperature characteristic of $-V_{DET}$	$\frac{\Delta -V_{DET}}{\Delta T_a}$	$T_a = -30^\circ\text{C} \text{ to } 80^\circ\text{C}$	—	± 0.23	—	mV/°C	—	

5. S-80718AH-BF-T1 (Detection voltage : 1.756 to 1.844 V)

(Unless otherwise specified : Ta=25°C)

Parameter	Symbol	Conditions	Min.	Typ.	Max.	Unit	Test circuit	
Detection voltage	$-V_{DET}$		1.756	1.800	1.844	V	1	
Hysteresis width	V_{HYS}		$-V_{DET} \times 0.02$	$-V_{DET} \times 0.05$	$-V_{DET} \times 0.08$	V	1	
Current consumption	I_{SS}	$V_{DD} = 3.0 \text{ V}$	—	1.4	3.5	μA	2	
Operating voltage	V_{DD}		1.0	—	15.0	V	1	
Output current	I_{OUT}	Pch $V_{DS} = 0.5 \text{ V}$	$V_{DD} = 1.2 \text{ V}$	0.03	0.09	—	mA	4
		Nch $V_{DS} = 0.5 \text{ V}$	$V_{DD} = 4.8 \text{ V}$	4.06	8.36	—		3
Temperature characteristic of $-V_{DET}$	$\frac{\Delta -V_{DET}}{\Delta T_a}$	$T_a = -30^\circ\text{C} \text{ to } 80^\circ\text{C}$	—	± 0.23	—	mV/°C	—	

6. S-80719AL/AL-AG-X, S-80719AN/AN-DG-X
S-80719SL-AG-X, S-80719SN-DG-X (Detection voltage : 1.854 to 1.946 V)

(Unless otherwise specified : Ta=25°C)

Parameter	Symbol	Conditions	Min.	Typ.	Max.	Unit	Test circuit	
Detection voltage	$-V_{DET}$		1.854	1.900	1.946	V	1	
Hysteresis width	V_{HYS}		$-V_{DET} \times 0.02$	$-V_{DET} \times 0.05$	$-V_{DET} \times 0.08$	V	1	
Current consumption	I_{SS}	$V_{DD} = 3.0 \text{ V}$	—	1.4	3.5	μA	2	
Operating voltage	V_{DD}		1.0	—	15.0	V	1	
Output current	I_{OUT}	Nch $V_{DS} = 0.5 \text{ V}$	$V_{DD} = 1.2 \text{ V}$	0.23	0.50	—	mA	3
		Pch (CMOS output) $V_{DS} = 0.5 \text{ V}$	$V_{DD} = 4.8 \text{ V}$	0.36	0.62	—		4
Temperature characteristic of $-V_{DET}$	$\frac{\Delta -V_{DET}}{\Delta T_a}$	$T_a = -30^\circ\text{C} \text{ to } 80^\circ\text{C}$	—	± 0.24	—	mV/°C	—	

HIGH-PRECISION VOLTAGE DETECTOR
S-807 Series

7. S-80720AL-AH-X, S-80720AN/AN-DH-X
S-80720SL-AH-X, S-80720SN-DH-X (Detection voltage : 1.952 to 2.048 V)

(Unless otherwise specified : Ta=25°C)

Parameter	Symbol	Conditions	Min.	Typ.	Max.	Unit	Test circuit
Detection voltage	$-V_{DET}$		1.952	2.000	2.048	V	1
Hysteresis width	V_{HYS}		$-V_{DET} \times 0.02$	$-V_{DET} \times 0.05$	$-V_{DET} \times 0.08$	V	1
Current consumption	I_{SS}	$V_{DD} = 3.0\text{ V}$	—	1.4	3.5	μA	2
Operating voltage	V_{DD}		1.0	—	15.0	V	1
Output current	I_{OUT}	Nch $V_{DS} = 0.5\text{ V}$ $V_{DD} = 1.2\text{ V}$	0.23	0.50	—	mA	3
		Pch (CMOS output) $V_{DS} = 0.5\text{ V}$ $V_{DD} = 4.8\text{ V}$	0.36	0.62	—		4
Temperature characteristic of $-V_{DET}$	$\frac{\Delta -V_{DET}}{\Delta T_a}$	Ta=-30°C to 80°C	—	± 0.25	—	mV/°C	—

8. S-80721AL/AL-AJ-X, S-80721AN/AN-DJ-X
S-80721SL-AJ-X, S-80721SN-DJ-X (Detection voltage : 2.049 to 2.151 V)

(Unless otherwise specified : Ta=25°C)

Parameter	Symbol	Conditions	Min.	Typ.	Max.	Unit	Test circuit
Detection voltage	$-V_{DET}$		2.049	2.100	2.151	V	1
Hysteresis width	V_{HYS}		$-V_{DET} \times 0.02$	$-V_{DET} \times 0.05$	$-V_{DET} \times 0.08$	V	1
Current consumption	I_{SS}	$V_{DD} = 4.5\text{ V}$	—	1.4	3.5	μA	2
Operating voltage	V_{DD}		1.0	—	15.0	V	1
Output current	I_{OUT}	Nch $V_{DS} = 0.5\text{ V}$ $V_{DD} = 1.2\text{ V}$	0.23	0.50	—	mA	3
		Pch (CMOS output) $V_{DS} = 0.5\text{ V}$ $V_{DD} = 4.8\text{ V}$	0.36	0.62	—		4
Temperature characteristic of $-V_{DET}$	$\frac{\Delta -V_{DET}}{\Delta T_a}$	Ta=-30°C to 80°C	—	± 0.26	—	mV/°C	—

9. S-80722AL/AL-AK-X, S-80722AN/AN-DK-X (Detection voltage : 2.147 to 2.253 V)

(Unless otherwise specified : Ta=25°C)

Parameter	Symbol	Conditions	Min.	Typ.	Max.	Unit	Test circuit
Detection voltage	$-V_{DET}$		2.147	2.200	2.253	V	1
Hysteresis width	V_{HYS}		$-V_{DET} \times 0.02$	$-V_{DET} \times 0.05$	$-V_{DET} \times 0.08$	V	1
Current consumption	I_{SS}	$V_{DD} = 4.5\text{ V}$	—	1.4	3.5	μA	2
Operating voltage	V_{DD}		1.0	—	15.0	V	1
Output current	I_{OUT}	Nch $V_{DS} = 0.5\text{ V}$ $V_{DD} = 1.2\text{ V}$	0.23	0.50	—	mA	3
		Pch (CMOS output) $V_{DS} = 0.5\text{ V}$ $V_{DD} = 4.8\text{ V}$	0.36	0.62	—		4
Temperature characteristic of $-V_{DET}$	$\frac{\Delta -V_{DET}}{\Delta T_a}$	Ta=-30°C to 80°C	—	± 0.28	—	mV/°C	—

HIGH-PRECISION VOLTAGE DETECTOR

S-807 Series

10. S-80723AL/AL-AL-X, S-80723AN/AN-DL-X
 S-80723SL-AL-X, S-80723SN-DL-X (Detection voltage : 2.244 to 2.356 V)

(Unless otherwise specified : Ta=25°C)

Parameter	Symbol	Conditions	Min.	Typ.	Max.	Unit	Test circuit	
Detection voltage	$-V_{DET}$		2.244	2.300	2.356	V	1	
Hysteresis width	V_{HYS}		$-V_{DET} \times 0.02$	$-V_{DET} \times 0.05$	$-V_{DET} \times 0.08$	V	1	
Current consumption	I_{SS}	$V_{DD} = 4.5 V$	—	1.4	3.5	μA	2	
Operating voltage	V_{DD}		1.0	—	15.0	V	1	
Output current	I_{OUT}	Nch $V_{DS} = 0.5 V$	$V_{DD} = 1.2 V$	0.23	0.50	—	mA	3
		Pch (CMOS output) $V_{DS} = 0.5 V$	$V_{DD} = 4.8 V$	0.36	0.62	—		4
Temperature characteristic of - V_{DET}	$\frac{\Delta -V_{DET}}{\Delta Ta}$	$Ta = -30^{\circ}C$ to $80^{\circ}C$	—	± 0.29	—	mV/ $^{\circ}C$	—	

11. S-80724AL/AL-AM-X, S-80724AN/AN-DM-X, S-80724SN-DM-X (Detection voltage : 2.342 to 2.458 V)

(Unless otherwise specified : Ta=25°C)

Parameter	Symbol	Conditions	Min.	Typ.	Max.	Unit	Test circuit	
Detection voltage	$-V_{DET}$		2.342	2.400	2.458	V	1	
Hysteresis width	V_{HYS}		$-V_{DET} \times 0.02$	$-V_{DET} \times 0.05$	$-V_{DET} \times 0.08$	V	1	
Current consumption	I_{SS}	$V_{DD} = 4.5 V$	—	1.4	3.5	μA	2	
Operating voltage	V_{DD}		1.0	—	15.0	V	1	
Output current	I_{OUT}	Nch $V_{DS} = 0.5 V$	$V_{DD} = 1.2 V$	0.23	0.50	—	mA	3
		Pch (CMOS output) $V_{DS} = 0.5 V$	$V_{DD} = 4.8 V$	0.36	0.62	—		4
Temperature characteristic of - V_{DET}	$\frac{\Delta -V_{DET}}{\Delta Ta}$	$Ta = -30^{\circ}C$ to $80^{\circ}C$	—	± 0.30	—	mV/ $^{\circ}C$	—	

12. S-80725AL/AL-AN-X, S-80725AN/AN-DN-X
 S-80725SL-AN-X, S-80725SN-DN-X (Detection voltage : 2.440 to 2.560 V)

(Unless otherwise specified : Ta=25°C)

Parameter	Symbol	Conditions	Min.	Typ.	Max.	Unit	Test circuit	
Detection voltage	$-V_{DET}$		2.440	2.500	2.560	V	1	
Hysteresis width	V_{HYS}		$-V_{DET} \times 0.02$	$-V_{DET} \times 0.05$	$-V_{DET} \times 0.08$	V	1	
Current consumption	I_{SS}	$V_{DD} = 4.5 V$	—	1.4	3.5	μA	2	
Operating voltage	V_{DD}		1.0	—	15.0	V	1	
Output current	I_{OUT}	Nch $V_{DS} = 0.5 V$	$V_{DD} = 1.2 V$	0.23	0.50	—	mA	3
		Pch (CMOS output) $V_{DS} = 0.5 V$	$V_{DD} = 4.8 V$	0.36	0.62	—		4
Temperature characteristic of - V_{DET}	$\frac{\Delta -V_{DET}}{\Delta Ta}$	$Ta = -30^{\circ}C$ to $80^{\circ}C$	—	± 0.31	—	mV/ $^{\circ}C$	—	

13. S-80725AH-BN-X (Detection voltage : 2.440 to 2.560 V)

(Unless otherwise specified : Ta=25°C)

Parameter	Symbol	Conditions	Min.	Typ.	Max.	Unit	Test circuit	
Detection voltage	$-V_{DET}$		2.440	2.500	2.560	V	1	
Hysteresis width	V_{HYS}		$-V_{DET} \times 0.02$	$-V_{DET} \times 0.05$	$-V_{DET} \times 0.08$	V	1	
Current consumption	I_{SS}	$V_{DD} = 4.5\text{ V}$	—	1.4	3.5	μA	2	
Operating voltage	V_{DD}		1.0	—	15.0	V	1	
Output current	I_{OUT}	Pch $V_{DS} = 0.5\text{ V}$	$V_{DD} = 1.2\text{ V}$	0.03	0.09	—	mA	4
		Nch $V_{DS} = 0.5\text{ V}$	$V_{DD} = 4.8\text{ V}$	4.06	8.36	—		3
Temperature characteristic of - V_{DET}	$\frac{\Delta -V_{DET}}{\Delta T_a}$	$T_a = -30^\circ\text{C}$ to 80°C	—	± 0.31	—	mV/°C	—	

14. S-80726AL-AP-X, S-80726AN/AN-DP-X (Detection voltage : 2.537 to 2.663 V)

(Unless otherwise specified : Ta=25°C)

Parameter	Symbol	Conditions	Min.	Typ.	Max.	Unit	Test circuit	
Detection voltage	$-V_{DET}$		2.537	2.600	2.663	V	1	
Hysteresis width	V_{HYS}		$-V_{DET} \times 0.02$	$-V_{DET} \times 0.05$	$-V_{DET} \times 0.08$	V	1	
Current consumption	I_{SS}	$V_{DD} = 4.5\text{ V}$	—	1.0	3.0	μA	2	
Operating voltage	V_{DD}		1.0	—	15.0	V	1	
Output current	I_{OUT}	Nch $V_{DS} = 0.5\text{ V}$	$V_{DD} = 1.2\text{ V}$	0.23	0.50	—	mA	3
		Pch (CMOS output) $V_{DS} = 0.5\text{ V}$	$V_{DD} = 4.8\text{ V}$	0.36	0.62	—		4
Temperature characteristic of - V_{DET}	$\frac{\Delta -V_{DET}}{\Delta T_a}$	$T_a = -30^\circ\text{C}$ to 80°C	—	± 0.33	—	mV/°C	—	

15. S-80727AL/AL-AQ-X, S-80727AN/AN-DQ-X

S-80727SL-AQ-X, S-80727SN-DQ-X (Detection voltage : 2.635 to 2.765 V)

(Unless otherwise specified : Ta=25°C)

Parameter	Symbol	Conditions	Min.	Typ.	Max.	Unit	Test circuit	
Detection voltage	$-V_{DET}$		2.635	2.700	2.765	V	1	
Hysteresis width	V_{HYS}		$-V_{DET} \times 0.02$	$-V_{DET} \times 0.05$	$-V_{DET} \times 0.08$	V	1	
Current consumption	I_{SS}	$V_{DD} = 4.5\text{ V}$	—	1.0	3.0	μA	2	
Operating voltage	V_{DD}		1.0	—	15.0	V	1	
Output current	I_{OUT}	Nch $V_{DS} = 0.5\text{ V}$	$V_{DD} = 1.2\text{ V}$	0.23	0.50	—	mA	3
			$V_{DD} = 2.4\text{ V}$	1.60	3.70	—		
		Pch (CMOS output) $V_{DS} = 0.5\text{ V}$	$V_{DD} = 4.8\text{ V}$	0.36	0.62	—		4
Temperature characteristic of - V_{DET}	$\frac{\Delta -V_{DET}}{\Delta T_a}$	$T_a = -30^\circ\text{C}$ to 80°C	—	± 0.34	—	mV/°C	—	

HIGH-PRECISION VOLTAGE DETECTOR

S-807 Series

16. S-80728AL-AR-X, S-80728AN/AN-DR-X
S-80728SL-AR-X, S-80728SN-DR-X (Detection voltage : 2.732 to 2.868 V)

(Unless otherwise specified : Ta=25°C)

Parameter	Symbol	Conditions	Min.	Typ.	Max.	Unit	Test circuit	
Detection voltage	$-V_{DET}$		2.732	2.800	2.868	V	1	
Hysteresis width	V_{HYS}		$-V_{DET} \times 0.02$	$-V_{DET} \times 0.05$	$-V_{DET} \times 0.08$	V	1	
Current consumption	I_{SS}	$V_{DD} = 4.5 V$	—	1.0	3.0	μA	2	
Operating voltage	V_{DD}		1.0	—	15.0	V	1	
Output current	I_{OUT}	Nch $V_{DS} = 0.5 V$	$V_{DD} = 1.2 V$	0.23	0.50	—	mA	3
			$V_{DD} = 2.4 V$	1.60	3.70	—		
		Pch (CMOS output) $V_{DS} = 0.5 V$	$V_{DD} = 4.8 V$	0.36	0.62	—		4
Temperature characteristic of $-V_{DET}$	$\frac{\Delta -V_{DET}}{\Delta Ta}$	$Ta = -30^{\circ}C$ to $80^{\circ}C$	—	± 0.35	—	mV/ $^{\circ}C$	—	

17. S-80729AL/AL-AS-X, S-80729AN-DS-X (Detection voltage : 2.830 to 2.970 V)

(Unless otherwise specified : Ta=25°C)

Parameter	Symbol	Conditions	Min.	Typ.	Max.	Unit	Test circuit	
Detection voltage	$-V_{DET}$		2.830	2.900	2.970	V	1	
Hysteresis width	V_{HYS}		$-V_{DET} \times 0.02$	$-V_{DET} \times 0.05$	$-V_{DET} \times 0.08$	V	1	
Current consumption	I_{SS}	$V_{DD} = 4.5 V$	—	1.0	3.0	μA	2	
Operating voltage	V_{DD}		1.0	—	15.0	V	1	
Output current	I_{OUT}	Nch $V_{DS} = 0.5 V$	$V_{DD} = 1.2 V$	0.23	0.50	—	mA	3
			$V_{DD} = 2.4 V$	1.60	3.70	—		
		Pch (CMOS output) $V_{DS} = 0.5 V$	$V_{DD} = 4.8 V$	0.36	0.62	—		4
Temperature characteristic of $-V_{DET}$	$\frac{\Delta -V_{DET}}{\Delta Ta}$	$Ta = -30^{\circ}C$ to $80^{\circ}C$	—	± 0.36	—	mV/ $^{\circ}C$	—	

18. S-80730AL/AL-AT-X, S-80730AN/AN-DT-X
S-80730SL-AT-X, S-80730SN-DT-X (Detection voltage : 2.928 to 3.072 V)

(Unless otherwise specified : Ta=25°C)

Parameter	Symbol	Conditions	Min.	Typ.	Max.	Unit	Test circuit	
Detection voltage	$-V_{DET}$		2.928	3.000	3.072	V	1	
Hysteresis width	V_{HYS}		$-V_{DET} \times 0.02$	$-V_{DET} \times 0.05$	$-V_{DET} \times 0.08$	V	1	
Current consumption	I_{SS}	$V_{DD} = 4.5 V$	—	1.0	3.0	μA	2	
Operating voltage	V_{DD}		1.0	—	15.0	V	1	
Output current	I_{OUT}	Nch $V_{DS} = 0.5 V$	$V_{DD} = 1.2 V$	0.23	0.50	—	mA	3
			$V_{DD} = 2.4 V$	1.60	3.70	—		
		Pch (CMOS output) $V_{DS} = 0.5 V$	$V_{DD} = 4.8 V$	0.36	0.62	—		4
Temperature characteristic of $-V_{DET}$	$\frac{\Delta -V_{DET}}{\Delta Ta}$	$Ta = -30^{\circ}C$ to $80^{\circ}C$	—	± 0.38	—	mV/ $^{\circ}C$	—	

HIGH-PRECISION VOLTAGE DETECTOR
S-807 Series

19. S-80731AL/AL-AV-X, S-80731AN/AN-DV-X (Detection voltage : 3.025 to 3.175 V)

(Unless otherwise specified : Ta=25°C)

Parameter	Symbol	Conditions	Min.	Typ.	Max.	Unit	Test circuit	
Detection voltage	$-V_{DET}$		3.025	3.100	3.175	V	1	
Hysteresis width	V_{HYS}		$-V_{DET} \times 0.02$	$-V_{DET} \times 0.05$	$-V_{DET} \times 0.08$	V	1	
Current consumption	I_{SS}	$V_{DD} = 4.5\text{ V}$	—	1.0	3.0	μA	2	
Operating voltage	V_{DD}		1.0	—	15.0	V	1	
Output current	I_{OUT}	Nch $V_{DS} = 0.5\text{ V}$	$V_{DD} = 1.2\text{ V}$	0.23	0.50	—	mA	3
			$V_{DD} = 2.4\text{ V}$	1.60	3.70	—		
		Pch (CMOS output) $V_{DS} = 0.5\text{ V}$	$V_{DD} = 4.8\text{ V}$	0.36	0.62	—		4
Temperature characteristic of $-V_{DET}$	$\frac{\Delta -V_{DET}}{\Delta T_a}$	$T_a = -30^\circ\text{C}$ to 80°C	—	± 0.39	—	mV/°C	—	

20. S-80731AH/AH-BV-X (Detection voltage : 3.025 to 3.175 V)

(Unless otherwise specified : Ta=25°C)

Parameter	Symbol	Conditions	Min.	Typ.	Max.	Unit	Test circuit	
Detection voltage	$-V_{DET}$		3.025	3.100	3.175	V	1	
Hysteresis width	V_{HYS}		$-V_{DET} \times 0.02$	$-V_{DET} \times 0.05$	$-V_{DET} \times 0.08$	V	1	
Current consumption	I_{SS}	$V_{DD} = 4.5\text{ V}$	—	1.0	3.0	μA	2	
Operating voltage	V_{DD}		1.0	—	15.0	V	1	
Output current	I_{OUT}	Pch $V_{DS} = 0.5\text{ V}$	$V_{DD} = 1.2\text{ V}$	0.03	0.09	—	mA	4
			$V_{DD} = 2.4\text{ V}$	0.15	0.30	—		
		Nch $V_{DS} = 0.5\text{ V}$	$V_{DD} = 4.8\text{ V}$	4.06	8.36	—		3
Temperature characteristic of $-V_{DET}$	$\frac{\Delta -V_{DET}}{\Delta T_a}$	$T_a = -30^\circ\text{C}$ to 80°C	—	± 0.39	—	mV/°C	—	

21. S-80732AL/AL-AW-X, S-80732AN/AN-DW-X, S-80732SL-AW-X (Detection voltage : 3.123 to 3.277 V)

(Unless otherwise specified : Ta=25°C)

Parameter	Symbol	Conditions	Min.	Typ.	Max.	Unit	Test circuit	
Detection voltage	$-V_{DET}$		3.123	3.200	3.277	V	1	
Hysteresis width	V_{HYS}		$-V_{DET} \times 0.02$	$-V_{DET} \times 0.05$	$-V_{DET} \times 0.08$	V	1	
Current consumption	I_{SS}	$V_{DD} = 4.5\text{ V}$	—	1.0	3.0	μA	2	
Operating voltage	V_{DD}		1.0	—	15.0	V	1	
Output current	I_{OUT}	Nch $V_{DS} = 0.5\text{ V}$	$V_{DD} = 1.2\text{ V}$	0.23	0.50	—	mA	3
			$V_{DD} = 2.4\text{ V}$	1.60	3.70	—		
		Pch (CMOS output) $V_{DS} = 0.5\text{ V}$	$V_{DD} = 4.8\text{ V}$	0.36	0.62	—		4
Temperature characteristic of $-V_{DET}$	$\frac{\Delta -V_{DET}}{\Delta T_a}$	$T_a = -30^\circ\text{C}$ to 80°C	—	± 0.40	—	mV/°C	—	

HIGH-PRECISION VOLTAGE DETECTOR
S-807 Series

22. S-80733AL/AL-AX-X, S-80733AN/AN-DX-X
 S-80733SL-AX-X, S-80733SN-DX-X (Detection voltage : 3.220 to 3.380 V)

(Unless otherwise specified : Ta=25°C)

Parameter	Symbol	Conditions	Min.	Typ.	Max.	Unit	Test circuit	
Detection voltage	$-V_{DET}$		3.220	3.300	3.380	V	1	
Hysteresis width	V_{HYS}		$-V_{DET} \times 0.02$	$-V_{DET} \times 0.05$	$-V_{DET} \times 0.08$	V	1	
Current consumption	I_{SS}	$V_{DD} = 4.5 V$	—	1.0	3.0	μA	2	
Operating voltage	V_{DD}		1.0	—	15.0	V	1	
Output current	I_{OUT}	Nch $V_{DS} = 0.5 V$	$V_{DD} = 1.2 V$	0.23	0.50	—	mA	3
			$V_{DD} = 2.4 V$	1.60	3.70	—		
		Pch (CMOS output) $V_{DS} = 0.5 V$	$V_{DD} = 4.8 V$	0.36	0.62	—	4	
Temperature characteristic of $-V_{DET}$	$\frac{\Delta -V_{DET}}{\Delta Ta}$	Ta=-30°C to 80°C	—	± 0.41	—	mV/°C	—	

23. S-80733AH (Detection voltage : 3.220 to 3.380 V)

(Unless otherwise specified : Ta=25°C)

Parameter	Symbol	Conditions	Min.	Typ.	Max.	Unit	Test circuit	
Detection voltage	$-V_{DET}$		3.220	3.300	3.380	V	1	
Hysteresis width	V_{HYS}		$-V_{DET} \times 0.02$	$-V_{DET} \times 0.05$	$-V_{DET} \times 0.08$	V	1	
Current consumption	I_{SS}	$V_{DD} = 4.5 V$	—	1.0	3.0	μA	2	
Operating voltage	V_{DD}		1.0	—	15.0	V	1	
Output current	I_{OUT}	Pch $V_{OS} = 0.5 V$	$V_{DD} = 1.2 V$	0.03	0.09	—	mA	4
			$V_{DD} = 2.4 V$	0.15	0.30	—		
		Nch $V_{DS} = 0.5 V$	$V_{DD} = 4.8 V$	4.06	8.36	—	3	
Temperature characteristic of $-V_{DET}$	$\frac{\Delta -V_{DET}}{\Delta Ta}$	Ta=-30°C to 80°C	—	± 0.41	—	mV/°C	—	

24. S-80734AL/AL-AY-X, S-80734AN/AN-DY-X (Detection voltage : 3.318 to 3.482 V)

(Unless otherwise specified : Ta=25°C)

Parameter	Symbol	Conditions	Min.	Typ.	Max.	Unit	Test circuit	
Detection voltage	$-V_{DET}$		3.318	3.400	3.482	V	1	
Hysteresis width	V_{HYS}		$-V_{DET} \times 0.02$	$-V_{DET} \times 0.05$	$-V_{DET} \times 0.08$	V	1	
Current consumption	I_{SS}	$V_{DD} = 4.5 V$	—	1.0	3.0	μA	2	
Operating voltage	V_{DD}		1.0	—	15.0	V	1	
Output current	I_{OUT}	Nch $V_{OS} = 0.5 V$	$V_{DD} = 1.2 V$	0.23	0.50	—	mA	3
			$V_{DD} = 2.4 V$	1.60	3.70	—		
		Pch (CMOS output) $V_{DS} = 0.5 V$	$V_{DD} = 4.8 V$	0.36	0.62	—	4	
Temperature characteristic of $-V_{DET}$	$\frac{\Delta -V_{DET}}{\Delta Ta}$	Ta=-30°C to 80°C	—	± 0.43	—	mV/°C	—	

25. S-80735AL/AL-AZ-X, S-80735AN/AN-DZ-X
S-80735SL-AZ-X, S-80735SN-DZ-X (Detection voltage : 3.416 to 3.584 V)

(Unless otherwise specified : Ta=25°C)

Parameter	Symbol	Conditions	Min.	Typ.	Max.	Unit	Test circuit	
Detection voltage	$-V_{DET}$		3.416	3.500	3.584	V	1	
Hysteresis width	V_{HYS}		$-V_{DET} \times 0.02$	$-V_{DET} \times 0.05$	$-V_{DET} \times 0.08$	V	1	
Current consumption	I_{SS}	$V_{DD} = 4.5 \text{ V}$	—	1.0	3.0	μA	2	
Operating voltage	V_{DD}		1.0	—	15.0	V	1	
Output current	I_{OUT}	Nch $V_{DS} = 0.5 \text{ V}$	$V_{DD} = 1.2 \text{ V}$	0.23	0.50	—	mA	3
			$V_{DD} = 2.4 \text{ V}$	1.60	3.70	—		
		Pch (CMOS output) $V_{DS} = 0.5 \text{ V}$	$V_{DD} = 4.8 \text{ V}$	0.36	0.62	—		4
Temperature characteristic of $-V_{DET}$	$\frac{\Delta -V_{DET}}{\Delta T_a}$	Ta=-30°C to 80°C	—	± 0.44	—	mV/°C	—	

26. S-80736AL-A0-X, S-80736AN/AN-D0-X (Detection voltage : 3.513 to 3.687 V)

(Unless otherwise specified : Ta=25°C)

Parameter	Symbol	Conditions	Min.	Typ.	Max.	Unit	Test circuit	
Detection voltage	$-V_{DET}$		3.513	3.600	3.687	V	1	
Hysteresis width	V_{HYS}		$-V_{DET} \times 0.02$	$-V_{DET} \times 0.05$	$-V_{DET} \times 0.08$	V	1	
Current consumption	I_{SS}	$V_{DD} = 4.5 \text{ V}$	—	1.0	3.0	μA	2	
Operating voltage	V_{DD}		1.0	—	15.0	V	1	
Output current	I_{OUT}	Nch $V_{DS} = 0.5 \text{ V}$	$V_{DD} = 1.2 \text{ V}$	0.23	0.50	—	mA	3
			$V_{DD} = 2.4 \text{ V}$	1.60	3.70	—		
		Pch (CMOS output) $V_{DS} = 0.5 \text{ V}$	$V_{DD} = 4.8 \text{ V}$	0.36	0.62	—		4
Temperature characteristic of $-V_{DET}$	$\frac{\Delta -V_{DET}}{\Delta T_a}$	Ta=-30°C to 80°C	—	± 0.45	—	mV/°C	—	

27. S-80737AL/AL-A1-X, S-80737AN/AN-D1-X (Detection voltage : 3.611 to 3.789 V)

(Unless otherwise specified : Ta=25°C)

Parameter	Symbol	Conditions	Min.	Typ.	Max.	Unit	Test circuit	
Detection voltage	$-V_{DET}$		3.611	3.700	3.789	V	1	
Hysteresis width	V_{HYS}		$-V_{DET} \times 0.02$	$-V_{DET} \times 0.05$	$-V_{DET} \times 0.08$	V	1	
Current consumption	I_{SS}	$V_{DD} = 6.0 \text{ V}$	—	1.0	3.0	μA	2	
Operating voltage	V_{DD}		1.0	—	15.0	V	1	
Output current	I_{OUT}	Nch $V_{DS} = 0.5 \text{ V}$	$V_{DD} = 1.2 \text{ V}$	0.23	0.50	—	mA	3
			$V_{DD} = 2.4 \text{ V}$	1.60	3.70	—		
		Pch (CMOS output) $V_{DS} = 0.5 \text{ V}$	$V_{DD} = 4.8 \text{ V}$	0.36	0.62	—		4
Temperature characteristic of $-V_{DET}$	$\frac{\Delta -V_{DET}}{\Delta T_a}$	Ta=-30°C to 80°C	—	± 0.46	—	mV/°C	—	

HIGH-PRECISION VOLTAGE DETECTOR

S-807 Series

28. S-80738AL/AL-A2-X, S-80738AN/AN-D2-X (Detection voltage : 3.708 to 3.892 V)

(Unless otherwise specified : Ta=25°C)

Parameter	Symbol	Conditions	Min.	Typ.	Max.	Unit	Test circuit	
Detection voltage	$-V_{DET}$		3.708	3.800	3.892	V	1	
Hysteresis width	V_{HYS}		$-V_{DET} \times 0.02$	$-V_{DET} \times 0.05$	$-V_{DET} \times 0.08$	V	1	
Current consumption	I_{SS}	$V_{DD} = 6.0 V$	—	1.0	3.0	μA	2	
Operating voltage	V_{DD}		1.0	—	15.0	V	1	
Output current	I_{OUT}	Nch $V_{DS} = 0.5 V$	$V_{DD} = 1.2 V$	0.23	0.50	—	mA	3
			$V_{DD} = 2.4 V$	1.60	3.70	—		
		Pch (CMOS output) $V_{DS} = 0.5 V$	$V_{DD} = 4.8 V$	0.36	0.62	—	4	
Temperature characteristic of $-V_{DET}$	$\frac{\Delta -V_{DET}}{\Delta Ta}$	Ta=-30°C to 80°C	—	± 0.48	—	mV/°C	—	

29. S-80739AL/AL-A3-X, S-80739AN/AN-D3-X (Detection voltage : 3.806 to 3.994 V)

(Unless otherwise specified : Ta=25°C)

Parameter	Symbol	Conditions	Min.	Typ.	Max.	Unit	Test circuit	
Detection voltage	$-V_{DET}$		3.806	3.900	3.994	V	1	
Hysteresis width	V_{HYS}		$-V_{DET} \times 0.02$	$-V_{DET} \times 0.05$	$-V_{DET} \times 0.08$	V	1	
Current consumption	I_{SS}	$V_{DD} = 6.0 V$	—	1.0	3.0	μA	2	
Operating voltage	V_{DD}		1.0	—	15.0	V	1	
Output current	I_{OUT}	Nch $V_{DS} = 0.5 V$	$V_{DD} = 1.2 V$	0.23	0.50	—	mA	3
			$V_{DD} = 2.4 V$	1.60	3.70	—		
		Pch (CMOS output) $V_{DS} = 0.5 V$	$V_{DD} = 4.8 V$	0.36	0.62	—	4	
Temperature characteristic of $-V_{DET}$	$\frac{\Delta -V_{DET}}{\Delta Ta}$	Ta=-30°C to 80°C	—	± 0.49	—	mV/°C	—	

30. S-80740AL/AL-A4-X, S-80740AN/AN-D4-X
S-80740SL-A4-X, S-80740SN-D4-X (Detection voltage : 3.904 to 4.096 V)

(Unless otherwise specified : Ta=25°C)

Parameter	Symbol	Conditions	Min.	Typ.	Max.	Unit	Test circuit	
Detection voltage	$-V_{DET}$		3.904	4.00	4.096	V	1	
Hysteresis width	V_{HYS}		$-V_{DET} \times 0.02$	$-V_{DET} \times 0.05$	$-V_{DET} \times 0.08$	V	1	
Current consumption	I_{SS}	$V_{DD} = 6.0 V$	—	1.0	3.0	μA	2	
Operating voltage	V_{DD}		1.0	—	15.0	V	1	
Output current	I_{OUT}	Nch $V_{DS} = 0.5 V$	$V_{DD} = 1.2 V$	0.23	0.50	—	mA	3
			$V_{DD} = 2.4 V$	1.60	3.70	—		
			$V_{DD} = 3.6 V$	3.18	7.00	—		
		Pch (CMOS output) $V_{DS} = 0.5 V$	$V_{DD} = 6.0 V$	0.46	0.75	—	4	
Temperature characteristic of $-V_{DET}$	$\frac{\Delta -V_{DET}}{\Delta Ta}$	Ta=-30°C to 80°C	—	± 0.5	—	mV/°C	—	

31. S-80740AH/AH-B4-X (Detection voltage : 3.904 to 4.096 V)

(Unless otherwise specified : Ta=25°C)

Parameter	Symbol	Conditions	Min.	Typ.	Max.	Unit	Test circuit	
Detection voltage	$-V_{DET}$		3.904	4.000	4.096	V	1	
Hysteresis width	V_{HYS}		$-V_{DET} \times 0.02$	$-V_{DET} \times 0.05$	$-V_{DET} \times 0.08$	V	1	
Current consumption	I_{SS}	$V_{DD} = 6.0\text{ V}$	—	1.0	3.0	μA	2	
Operating voltage	V_{DD}		1.0	—	15.0	V	1	
Output current	I_{OUT}	Pch $V_{DS} = 0.5\text{ V}$	$V_{DD} = 1.2\text{ V}$	0.03	0.09	—	mA	4
			$V_{DD} = 2.4\text{ V}$	0.15	0.30	—		
		Nch $V_{DS} = 0.5\text{ V}$	$V_{DD} = 6.0\text{ V}$	4.73	9.60	—		3
Temperature characteristic of $-V_{DET}$	$\frac{\Delta -V_{DET}}{\Delta T_a}$	$T_a = -30^\circ\text{C}$ to 80°C	—	± 0.5	—	mV/°C	—	

32. S-80741AL/AL-A5-X, S-80741AN/AN-D5-X (Detection voltage : 4.001 to 4.199 V)

(Unless otherwise specified : Ta=25°C)

Parameter	Symbol	Conditions	Min.	Typ.	Max.	Unit	Test circuit	
Detection voltage	$-V_{DET}$		4.001	4.100	4.199	V	1	
Hysteresis width	V_{HYS}		$-V_{DET} \times 0.02$	$-V_{DET} \times 0.05$	$-V_{DET} \times 0.08$	V	1	
Current consumption	I_{SS}	$V_{DD} = 6.0\text{ V}$	—	1.0	3.0	μA	2	
Operating voltage	V_{DD}		1.0	—	15.0	V	1	
Output current	I_{OUT}	Nch $V_{DS} = 0.5\text{ V}$	$V_{DD} = 1.2\text{ V}$	0.23	0.50	—	mA	3
			$V_{DD} = 2.4\text{ V}$	1.60	3.70	—		
			$V_{DD} = 3.6\text{ V}$	3.18	7.00	—		
		Pch (CMOS output) $V_{DS} = 0.5\text{ V}$	$V_{DD} = 6.0\text{ V}$	0.46	0.75	—		4
Temperature characteristic of $-V_{DET}$	$\frac{\Delta -V_{DET}}{\Delta T_a}$	$T_a = -30^\circ\text{C}$ to 80°C	—	± 0.51	—	mV/°C	—	

33. S-80742AL/AL-A6-X, S-80742AN/AN-D6-X
S-80742SL-A6-X, S-80742SN-D6-X (Detection voltage : 4.099 to 4.301 V)

(Unless otherwise specified : Ta=25°C)

Parameter	Symbol	Conditions	Min.	Typ.	Max.	Unit	Test circuit	
Detection voltage	$-V_{DET}$		4.099	4.200	4.301	V	1	
Hysteresis width	V_{HYS}		$-V_{DET} \times 0.02$	$-V_{DET} \times 0.05$	$-V_{DET} \times 0.08$	V	1	
Current consumption	I_{SS}	$V_{DD} = 6.0\text{ V}$	—	1.0	3.0	μA	2	
Operating voltage	V_{DD}		1.0	—	15.0	V	1	
Output current	I_{OUT}	Nch $V_{DS} = 0.5\text{ V}$	$V_{DD} = 1.2\text{ V}$	0.23	0.50	—	mA	3
			$V_{DD} = 2.4\text{ V}$	1.60	3.70	—		
			$V_{DD} = 3.6\text{ V}$	3.18	7.00	—		
		Pch (CMOS output) $V_{DS} = 0.5\text{ V}$	$V_{DD} = 6.0\text{ V}$	0.46	0.75	—		4
Temperature characteristic of $-V_{DET}$	$\frac{\Delta -V_{DET}}{\Delta T_a}$	$T_a = -30^\circ\text{C}$ to 80°C	—	± 0.53	—	mV/°C	—	

HIGH-PRECISION VOLTAGE DETECTOR

S-807 Series

34. S-80743AL/AL-A7-X, S-80743AN/AN-D7-X (Detection voltage : 4.196 to 4.404 V)

(Unless otherwise specified : Ta=25°C)

Parameter	Symbol	Conditions	Min.	Typ.	Max.	Unit	Test circuit	
Detection voltage	$-V_{DET}$		4.196	4.300	4.404	V	1	
Hysteresis width	V_{HYS}		$-V_{DET} \times 0.02$	$-V_{DET} \times 0.05$	$-V_{DET} \times 0.08$	V	1	
Current consumption	I_{SS}	$V_{DD} = 6.0 \text{ V}$	—	1.0	3.0	μA	2	
Operating voltage	V_{DD}		1.0	—	15.0	V	1	
Output current	I_{OUT}	Nch $V_{DS} = 0.5 \text{ V}$	$V_{DD} = 1.2 \text{ V}$	0.23	0.50	—	mA	3
			$V_{DD} = 2.4 \text{ V}$	1.60	3.70	—		
			$V_{DD} = 3.6 \text{ V}$	3.18	7.00	—		
		Pch (CMOS output) $V_{DS} = 0.5 \text{ V}$	$V_{DD} = 6.0 \text{ V}$	0.46	0.75	—	4	
Temperature characteristic of $-V_{DET}$	$\frac{\Delta -V_{DET}}{\Delta T_a}$	Ta=-30°C to 80°C	—	± 0.54	—	mV/°C	—	

35. S-80744AL/AL-A8-X, S-80744AN/AN-D8-X, S-80744SN-D8-X (Detection voltage : 4.294 to 4.506 V)

(Unless otherwise specified : Ta=25°C)

Parameter	Symbol	Conditions	Min.	Typ.	Max.	Unit	Test circuit	
Detection voltage	$-V_{DET}$		4.294	4.400	4.506	V	1	
Hysteresis width	V_{HYS}		$-V_{DET} \times 0.02$	$-V_{DET} \times 0.05$	$-V_{DET} \times 0.08$	V	1	
Current consumption	I_{SS}	$V_{DD} = 6.0 \text{ V}$	—	1.0	3.0	μA	2	
Operating voltage	V_{DD}		1.0	—	15.0	V	1	
Output current	I_{OUT}	Nch $V_{DS} = 0.5 \text{ V}$	$V_{DD} = 1.2 \text{ V}$	0.23	0.50	—	mA	3
			$V_{DD} = 2.4 \text{ V}$	1.60	3.70	—		
			$V_{DD} = 3.6 \text{ V}$	3.18	7.00	—		
		Pch (CMOS output) $V_{DS} = 0.5 \text{ V}$	$V_{DD} = 6.0 \text{ V}$	0.46	0.75	—	4	
Temperature characteristic of $-V_{DET}$	$\frac{\Delta -V_{DET}}{\Delta T_a}$	Ta=-30°C to 80°C	—	± 0.55	—	mV/°C	—	

36. S-80744HL/HL-U8-X (Detection voltage : 4.295 to 4.605 V)

(Unless otherwise specified : Ta=25°C)

Parameter	Symbol	Conditions	Min.	Typ.	Max.	Unit	Test circuit	
Detection voltage	$-V_{DET}$		4.295	4.450	4.605	V	1	
Release voltage	$+V_{DET}$		—	—	4.70	V	1	
Current consumption	I_{SS}	$V_{DD} = 6.0 \text{ V}$	—	2.6	6.0	μA	2	
Operating voltage	V_{DD}		1.0	—	15.0	V	1	
Output current	I_{OUT}	Nch $V_{DS} = 0.5 \text{ V}$	$V_{DD} = 1.2 \text{ V}$	0.23	0.50	—	mA	3
			$V_{DD} = 2.4 \text{ V}$	1.60	3.70	—		
		Pch $V_{DS} = 0.5 \text{ V}$	$V_{DD} = 4.8 \text{ V}$	0.36	0.62	—	4	
Temperature characteristic of $-V_{DET}$	$\frac{\Delta -V_{DET}}{\Delta T_a}$	Ta=-30°C to 80°C	—	± 0.56	—	mV/°C	—	

37. S-80745AL/AL-A9-X, S-80745AN/AN-D9-X
S-80745SL-A9-X, S-80745SN-D9-X (Detection voltage : 4.392 to 4.608 V)

(Unless otherwise specified : Ta=25°C)

Parameter	Symbol	Conditions	Min.	Typ.	Max.	Unit	Test circuit	
Detection voltage	$-V_{DET}$		4.392	4.50	4.608	V	1	
Hysteresis width	V_{HYS}		$-V_{DET} \times 0.02$	$-V_{DET} \times 0.05$	$-V_{DET} \times 0.08$	V	1	
Current consumption	I_{SS}	$V_{DD} = 6.0\text{ V}$	—	1.0	3.0	μA	2	
Operating voltage	V_{DD}		1.0	—	15.0	V	1	
Output current	I_{OUT}	Nch $V_{DS} = 0.5\text{ V}$	$V_{DD} = 1.2\text{ V}$	0.23	0.50	—	mA	3
			$V_{DD} = 2.4\text{ V}$	1.60	3.70	—		
			$V_{DD} = 3.6\text{ V}$	3.18	7.00	—		
		Pch (CMOS output) $V_{DS} = 0.5\text{ V}$	$V_{DD} = 6.0\text{ V}$	0.46	0.75	—		4
Temperature characteristic of $-V_{DET}$	$\frac{\Delta -V_{DET}}{\Delta T_a}$	$T_a = -30^\circ\text{C}$ to 80°C	—	± 0.56	—	mV/°C	—	

38. S-80745AH-B9-X (Detection voltage : 4.392 to 4.608 V)

(Unless otherwise specified : Ta=25°C)

Parameter	Symbol	Conditions	Min.	Typ.	Max.	Unit	Test circuit	
Detection voltage	$-V_{DET}$		4.392	4.500	4.608	V	1	
Hysteresis width	V_{HYS}		$-V_{DET} \times 0.02$	$-V_{DET} \times 0.05$	$-V_{DET} \times 0.08$	V	1	
Current consumption	I_{SS}	$V_{DD} = 6.0\text{ V}$	—	1.0	3.0	μA	2	
Operating voltage	V_{DD}		1.0	—	15.0	V	1	
Output current	I_{OUT}	Pch $V_{DS} = 0.5\text{ V}$	$V_{DD} = 1.2\text{ V}$	0.03	0.09	—	mA	4
			$V_{DD} = 2.4\text{ V}$	0.15	0.30	—		
			$V_{DD} = 6.0\text{ V}$	4.73	9.60	—		
		Nch $V_{DS} = 0.5\text{ V}$	$V_{DD} = 6.0\text{ V}$	4.73	9.60	—		3
Temperature characteristic of $-V_{DET}$	$\frac{\Delta -V_{DET}}{\Delta T_a}$	$T_a = -30^\circ\text{C}$ to 80°C	—	± 0.56	—	mV/°C	—	

39. S-80746AL/AL-EA-X, S-80746AN-JA-X (Detection voltage : 4.489 to 4.711 V)

(Unless otherwise specified : Ta=25°C)

Parameter	Symbol	Conditions	Min.	Typ.	Max.	Unit	Test circuit	
Detection voltage	$-V_{DET}$		4.489	4.600	4.711	V	1	
Hysteresis width	V_{HYS}		$-V_{DET} \times 0.02$	$-V_{DET} \times 0.05$	$-V_{DET} \times 0.08$	V	1	
Current consumption	I_{SS}	$V_{DD} = 6.0\text{ V}$	—	1.0	3.0	μA	2	
Operating voltage	V_{DD}		1.0	—	15.0	V	1	
Output current	I_{OUT}	Nch $V_{DS} = 0.5\text{ V}$	$V_{DD} = 1.2\text{ V}$	0.23	0.50	—	mA	3
			$V_{DD} = 2.4\text{ V}$	1.60	3.70	—		
			$V_{DD} = 3.6\text{ V}$	3.18	7.00	—		
		Pch (CMOS output) $V_{DS} = 0.5\text{ V}$	$V_{DD} = 6.0\text{ V}$	0.46	0.75	—		4
Temperature characteristic of $-V_{DET}$	$\frac{\Delta -V_{DET}}{\Delta T_a}$	$T_a = -30^\circ\text{C}$ to 80°C	—	± 0.58	—	mV/°C	—	

HIGH-PRECISION VOLTAGE DETECTOR

S-807 Series

40. S-80747AL/AL-EB-X, S-80747AN-JB-X (Detection voltage : 4.587 to 4.813 V)

(Unless otherwise specified : Ta=25°C)

Parameter	Symbol	Conditions	Min.	Typ.	Max.	Unit	Test circuit	
Detection voltage	$-V_{DET}$		4.587	4.700	4.813	V	1	
Hysteresis width	V_{HYS}		$-V_{DET} \times 0.02$	$-V_{DET} \times 0.05$	$-V_{DET} \times 0.08$	V	1	
Current consumption	I_{SS}	$V_{DD} = 6.0\text{ V}$	—	1.0	3.0	μA	2	
Operating voltage	V_{DD}		1.0	—	15.0	V	1	
Output current	I_{OUT}	Nch $V_{DS} = 0.5\text{ V}$	$V_{DD} = 1.2\text{ V}$	0.23	0.50	—	mA	3
			$V_{DD} = 2.4\text{ V}$	1.60	3.70	—		
			$V_{DD} = 3.6\text{ V}$	3.18	7.00	—		
		Pch (CMOS output) $V_{DS} = 0.5\text{ V}$	$V_{DD} = 6.0\text{ V}$	0.46	0.75	—	4	
Temperature characteristic of $-V_{DET}$	$\frac{\Delta -V_{DET}}{\Delta T_a}$	Ta=-30°C to 80°C	—	± 0.59	—	mV/°C	—	

41. S-80748AL-EC-X, S-80748AN/AN-JC-X (Detection voltage : 4.684 to 4.916 V)

(Unless otherwise specified : Ta=25°C)

Parameter	Symbol	Conditions	Min.	Typ.	Max.	Unit	Test circuit	
Detection voltage	$-V_{DET}$		4.684	4.800	4.916	V	1	
Hysteresis width	V_{HYS}		$-V_{DET} \times 0.02$	$-V_{DET} \times 0.05$	$-V_{DET} \times 0.08$	V	1	
Current consumption	I_{SS}	$V_{DD} = 6.0\text{ V}$	—	1.0	3.0	μA	2	
Operating voltage	V_{DD}		1.0	—	15.0	V	1	
Output current	I_{OUT}	Nch $V_{DS} = 0.5\text{ V}$	$V_{DD} = 1.2\text{ V}$	0.23	0.50	—	mA	3
			$V_{DD} = 2.4\text{ V}$	1.60	3.70	—		
			$V_{DD} = 3.6\text{ V}$	3.18	7.00	—		
		Pch (CMOS output) $V_{DS} = 0.5\text{ V}$	$V_{DD} = 6.0\text{ V}$	0.46	0.75	—	4	
Temperature characteristic of $-V_{DET}$	$\frac{\Delta -V_{DET}}{\Delta T_a}$	Ta=-30°C to 80°C	—	± 0.60	—	mV/°C	—	

42. S-80749AL-ED-X, S-80749AN-JD-X (Detection voltage : 4.782 to 5.018 V)

(Unless otherwise specified : Ta=25°C)

Parameter	Symbol	Conditions	Min.	Typ.	Max.	Unit	Test circuit	
Detection voltage	$-V_{DET}$		4.782	4.900	5.018	V	1	
Hysteresis width	V_{HYS}		$-V_{DET} \times 0.02$	$-V_{DET} \times 0.05$	$-V_{DET} \times 0.08$	V	1	
Current consumption	I_{SS}	$V_{DD} = 6.0\text{ V}$	—	1.0	3.0	μA	2	
Operating voltage	V_{DD}		1.0	—	15.0	V	1	
Output current	I_{OUT}	Nch $V_{DS} = 0.5\text{ V}$	$V_{DD} = 1.2\text{ V}$	0.23	0.50	—	mA	3
			$V_{DD} = 2.4\text{ V}$	1.60	3.70	—		
			$V_{DD} = 3.6\text{ V}$	3.18	7.00	—		
		Pch (CMOS output) $V_{DS} = 0.5\text{ V}$	$V_{DD} = 6.0\text{ V}$	0.46	0.75	—	4	
Temperature characteristic of $-V_{DET}$	$\frac{\Delta -V_{DET}}{\Delta T_a}$	Ta=-30°C to 80°C	—	± 0.61	—	mV/°C	—	

HIGH-PRECISION VOLTAGE DETECTOR
S-807 Series

43. S-80750AL-EE-X, S-80750AN/AN-JE-X
S-80750SL-EE-X, S-80750SN-JE-X (Detection voltage : 4.880 to 5.120 V)

(Unless otherwise specified : Ta=25°C)

Parameter	Symbol	Conditions	Min.	Typ.	Max.	Unit	Test circuit	
Detection voltage	$-V_{DET}$		4.880	5.000	5.120	V	1	
Hysteresis width	V_{HYS}		$-V_{DET} \times 0.02$	$-V_{DET} \times 0.05$	$-V_{DET} \times 0.08$	V	1	
Current consumption	I_{SS}	$V_{DD} = 6.0\text{ V}$	—	1.0	3.0	μA	2	
Operating voltage	V_{DD}		1.0	—	15.0	V	1	
Output current	I_{OUT}	Nch $V_{DS} = 0.5\text{ V}$	$V_{DD} = 1.2\text{ V}$	0.23	0.50	—	mA	3
			$V_{DD} = 2.4\text{ V}$	1.60	3.70	—		
			$V_{DD} = 3.6\text{ V}$	3.18	7.00	—		
		Pch (CMOS output) $V_{DS} = 0.5\text{ V}$	$V_{DD} = 6.0\text{ V}$	0.46	0.75	—	4	
Temperature characteristic of $-V_{DET}$	$\frac{\Delta -V_{DET}}{\Delta T_a}$	$T_a = -30^\circ\text{C}$ to 80°C	—	± 0.63	—	mV/°C	—	

44. S-80751AL, S-80751AN/AN-JF-X
S-80751SL-EF-X, S-80751SN-JF-X (Detection voltage : 4.977 to 5.223 V)

(Unless otherwise specified : Ta=25°C)

Parameter	Symbol	Conditions	Min.	Typ.	Max.	Unit	Test circuit	
Detection voltage	$-V_{DET}$		4.977	5.100	5.223	V	1	
Hysteresis width	V_{HYS}		$-V_{DET} \times 0.02$	$-V_{DET} \times 0.05$	$-V_{DET} \times 0.08$	V	1	
Current consumption	I_{SS}	$V_{DD} = 6.0\text{ V}$	—	1.0	3.0	μA	2	
Operating voltage	V_{DD}		1.0	—	15.0	V	1	
Output current	I_{OUT}	Nch $V_{DS} = 0.5\text{ V}$	$V_{DD} = 1.2\text{ V}$	0.23	0.50	—	mA	3
			$V_{DD} = 2.4\text{ V}$	1.60	3.70	—		
			$V_{DD} = 3.6\text{ V}$	3.18	7.00	—		
		Pch (CMOS output) $V_{DS} = 0.5\text{ V}$	$V_{DD} = 6.0\text{ V}$	0.46	0.75	—	4	
Temperature characteristic of $-V_{DET}$	$\frac{\Delta -V_{DET}}{\Delta T_a}$	$T_a = -30^\circ\text{C}$ to 80°C	—	± 0.64	—	mV/°C	—	

45. S-80752AL-EG-T1, S-80752AN-JE-T1,
S-80752SL-EG-T1 (Detection voltage : 5.075 to 5.325 V)

(Unless otherwise specified : Ta=25°C)

Parameter	Symbol	Conditions	Min.	Typ.	Max.	Unit	Test circuit	
Detection voltage	$-V_{DET}$		5.075	5.200	5.325	V	1	
Hysteresis width	V_{HYS}		$-V_{DET} \times 0.02$	$-V_{DET} \times 0.05$	$-V_{DET} \times 0.08$	V	1	
Current consumption	I_{SS}	$V_{DD} = 6.0\text{ V}$	—	1.0	3.0	μA	2	
Operating voltage	V_{DD}		1.0	—	15.0	V	1	
Output current	I_{OUT}	Nch $V_{DS} = 0.5\text{ V}$	$V_{DD} = 1.2\text{ V}$	0.23	0.50	—	mA	3
			$V_{DD} = 2.4\text{ V}$	1.60	3.70	—		
			$V_{DD} = 3.6\text{ V}$	3.18	7.00	—		
		Pch (CMOS output) $V_{DS} = 0.5\text{ V}$	$V_{DD} = 6.0\text{ V}$	0.46	0.75	—	4	
Temperature characteristic of $-V_{DET}$	$\frac{\Delta -V_{DET}}{\Delta T_a}$	$T_a = -30^\circ\text{C}$ to 80°C	—	± 0.65	—	mV/°C	—	

HIGH-PRECISION VOLTAGE DETECTOR

S-807 Series

46. S-80753AN (Detection voltage : 5.172 to 5.428 V)

(Unless otherwise specified : Ta=25°C)

Parameter	Symbol	Conditions	Min.	Typ.	Max.	Unit	Test circuit	
Detection voltage	$-V_{DET}$		5.172	5.300	5.428	V	1	
Hysteresis width	V_{HYS}		$-V_{DET} \times 0.02$	$-V_{DET} \times 0.05$	$-V_{DET} \times 0.08$	V	1	
Current consumption	I_{SS}	$V_{DD} = 6.0 V$	—	1.0	3.0	μA	2	
Operating voltage	V_{DD}		1.0	—	15.0	V	1	
Output current	I_{OUT}	Nch $V_{DS} = 0.5 V$	$V_{DD} = 1.2 V$	0.23	0.50	—	mA	3
			$V_{DD} = 2.4 V$	1.60	3.70	—		
			$V_{DD} = 3.6 V$	3.18	7.00	—		
		Pch (CMOS output) $V_{DS} = 0.5 V$	$V_{DD} = 6.0 V$	0.46	0.75	—	4	
Temperature characteristic of $-V_{DET}$	$\frac{\Delta -V_{DET}}{\Delta Ta}$	Ta=-30°C to 80°C	—	± 0.66	—	mV/°C	—	

47. S-80755AL-EK-X (Detection voltage : 5.368 to 5.632 V)

(Unless otherwise specified : Ta=25°C)

Parameter	Symbol	Conditions	Min.	Typ.	Max.	Unit	Test circuit	
Detection voltage	$-V_{DET}$		5.368	5.500	5.632	V	1	
Hysteresis width	V_{HYS}		$-V_{DET} \times 0.02$	$-V_{DET} \times 0.05$	$-V_{DET} \times 0.08$	V	1	
Current consumption	I_{SS}	$V_{DD} = 6.0 V$	—	1.0	3.0	μA	2	
Operating voltage	V_{DD}		1.0	—	15.0	V	1	
Output current	I_{OUT}	Nch $V_{DS} = 0.5 V$	$V_{DD} = 1.2 V$	0.23	0.50	—	mA	3
			$V_{DD} = 2.4 V$	1.60	3.70	—		
			$V_{DD} = 3.6 V$	3.18	7.00	—		
		Pch (CMOS output) $V_{DS} = 0.5 V$	$V_{DD} = 6.0 V$	0.46	0.75	—	4	
Temperature characteristic of $-V_{DET}$	$\frac{\Delta -V_{DET}}{\Delta Ta}$	Ta=-30°C to 80°C	—	± 0.69	—	mV/°C	—	

48. S-80761SL-ER-X (Detection voltage : 5.953 to 6.247 V)

(Unless otherwise specified : Ta=25°C)

Parameter	Symbol	Conditions	Min.	Typ.	Max.	Unit	Test circuit	
Detection voltage	$-V_{DET}$		5.953	6.100	6.247	V	1	
Hysteresis width	V_{HYS}		$-V_{DET} \times 0.02$	$-V_{DET} \times 0.05$	$-V_{DET} \times 0.08$	V	1	
Current consumption	I_{SS}	$V_{DD} = 7.5 V$	—	1.9	3.6	μA	2	
Operating voltage	V_{DD}		1.0	—	15.0	V	1	
Output current	I_{OUT}	Nch $V_{DS} = 0.5 V$	$V_{DD} = 1.2 V$	0.23	0.50	—	mA	3
			$V_{DD} = 2.4 V$	1.60	3.70	—		
			$V_{DD} = 3.6 V$	3.18	7.00	—		
			$V_{DD} = 4.8 V$	4.13	8.56	—		
		Pch (CMOS output) $V_{DS} = 0.5 V$	$V_{DD} = 8.4 V$	0.59	0.96	—	4	
Temperature characteristic of $-V_{DET}$	$\frac{\Delta -V_{DET}}{\Delta Ta}$	Ta=-30°C to 80°C	—	± 0.78	—	mV/°C	—	

49. S-80763AN-JT-X (Detection voltage : 6.148 to 6.452 V)

(Unless otherwise specified : Ta=25°C)

Parameter	Symbol	Conditions	Min.	Typ.	Max.	Unit	Test circuit	
Detection voltage	$-V_{DET}$		6.148	6.300	6.452	V	1	
Hysteresis width	V_{HYS}		$-V_{DET} \times 0.02$	$-V_{DET} \times 0.05$	$-V_{DET} \times 0.08$	V	1	
Current consumption	I_{SS}	$V_{DD} = 7.5\text{ V}$	—	1.9	3.6	μA	2	
Operating voltage	V_{DD}		1.0	—	15.0	V	1	
Output current	I_{OUT}	Nch $V_{DS} = 0.5\text{ V}$	$V_{DD} = 1.2\text{ V}$	0.23	0.50	—	mA	3
			$V_{DD} = 2.4\text{ V}$	1.60	3.70	—		
			$V_{DD} = 3.6\text{ V}$	3.18	7.00	—		
			$V_{DD} = 4.8\text{ V}$	4.13	8.56	—		
		Pch (CMOS output) $V_{DS} = 0.5\text{ V}$	$V_{DD} = 8.4\text{ V}$	0.59	0.96	—	4	
Temperature characteristic of - V_{DET}	$\frac{\Delta -V_{DET}}{\Delta T_a}$	Ta=-30°C to 80°C	—	± 0.81	—	mV/°C	—	

50. S-80777SN-J8-X (Detection voltage : 7.515 to 7.885 V)

(Unless otherwise specified : Ta=25°C)

Parameter	Symbol	Conditions	Min.	Typ.	Max.	Unit	Test circuit	
Detection voltage	$-V_{DET}$		7.515	7.700	7.885	V	1	
Hysteresis width	V_{HYS}		$-V_{DET} \times 0.02$	$-V_{DET} \times 0.05$	$-V_{DET} \times 0.08$	V	1	
Current consumption	I_{SS}	$V_{DD} = 9.0\text{ V}$	—	2.2	4.0	μA	2	
Operating voltage	V_{DD}		1.0	—	15.0	V	1	
Output current	I_{OUT}	Nch $V_{DS} = 0.5\text{ V}$	$V_{DD} = 1.2\text{ V}$	0.23	0.50	—	mA	3
			$V_{DD} = 2.4\text{ V}$	1.60	3.70	—		
			$V_{DD} = 3.6\text{ V}$	3.18	7.00	—		
			$V_{DD} = 4.8\text{ V}$	4.13	8.56	—		
			$V_{DD} = 6.0\text{ V}$	4.73	9.60	—		
		Pch (CMOS output) $V_{DS} = 0.5\text{ V}$	$V_{DD} = 9.6\text{ V}$	0.65	1.05	—	4	
Temperature characteristic of - V_{DET}	$\frac{\Delta -V_{DET}}{\Delta T_a}$	Ta=-30°C to 80°C	—	± 0.99	—	mV/°C	—	

■ Test Circuits

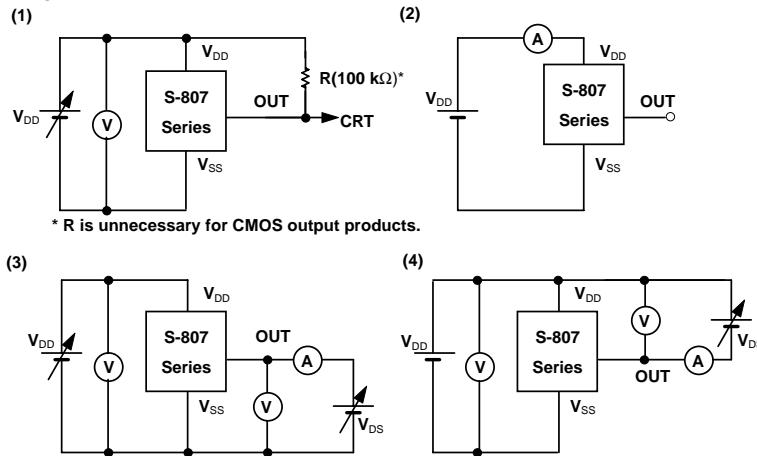

Figure 8

■ **Technical Terms**

1. Detection voltage ($-V_{DET}$)

Detection voltage $-V_{DET}$ is the voltage at which the detector's output goes active. In products with "Nch open-drain" and "CMOS active low output" configurations the output goes low on detection. It goes high in products with CMOS active high output configurations. This detection voltage varies slightly among products of the same type. The variation of voltages between the specified minimum [$(-V_{DET})_{min.}$] and maximum [$(-V_{DET})_{max.}$] values is called the detection voltage range. (See Figure 9.)

Example : For the S-80745AN, detection voltage lies in the range $4.392 \leq (-V_{DET}) \leq 4.608$.

2. Release voltage ($+V_{DET}$)

Release voltage $+V_{DET}$ is the voltage at which a unit's output returns (is "released") to its inactive state (high for Nch and CMOS active low output configurations, and low for CMOS active high output configurations). The value of this voltage for any single unit lies in a range determined from the value of that unit's detection voltage (see Figure 10):

$$(-V_{DET}) \times 1.02 \leq (+V_{DET}) \leq (-V_{DET}) \times 1.08.$$

Example : For an S-80745AN with $-V_{DET}=4.608$, release voltage lies in the range $4.700 \leq (+V_{DET}) \leq 4.997$.
 For an S-80745AN with $-V_{DET}=4.392$, release voltage lies in the range $4.480 \leq (+V_{DET}) \leq 4.743$.

When calculating the overall release voltage range for S-807 Series products, care must be taken to consider the variation in the series' detection voltage values. The minimum and maximum values for release voltage [$(+V_{DET})_{min.}$ and $(+V_{DET})_{max.}$] must be determined using $(-V_{DET})_{min.}$ and $(-V_{DET})_{max.}$:

$$(+V_{DET})_{min.} = [(-V_{DET})_{min.}] \times 1.02;$$

$$(+V_{DET})_{max.} = [(-V_{DET})_{max.}] \times 1.08.$$

Example : For S-80745AN voltage detectors, release voltage lies in the range $4.480 \leq (+V_{DET}) \leq 4.977$.

Note : Detection voltage ($-V_{DET}$) and Release voltage ($+V_{DET}$) range equally from 4.480V to 4.608V, however, $(+V_{DET}) > (-V_{DET})$.

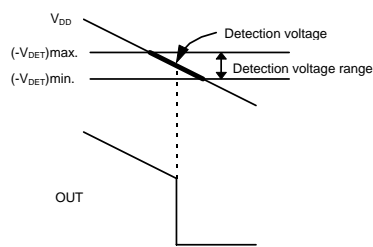

Figure 9

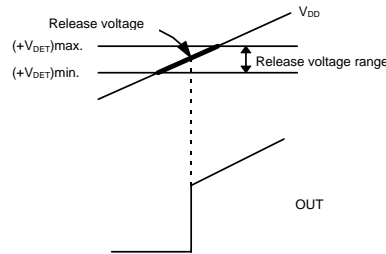

Figure 10

3. Hysteresis width (V_{HYS})

Hysteresis width is the voltage difference between a device's detection voltage and its release voltage (see Figure 14. $V_{HYS}=B-A$). By giving a device hysteresis, erroneous toggling of the output due to noise at the input is avoided.

4. Through-type current

Through-type current refers to the instantaneous current flow which occurs at the moment a voltage detector output toggles. This current is quite large in devices with CMOS configured outputs, and also occurs to some extent in Nch open-drain configured devices. S-807 Series voltage detectors are specially designed to limit through-type currents and are superior to S-805 Series devices in this respect. (See current consumption characteristics.)

5. Oscillation

In applications where a resistor is connected to the voltage detector input (Figure 11 and 12), the through-type current generated when the output goes from low to high (release) causes a voltage drop equal to [through-type current]×[input resistance] across the resistor. When the input voltage resultantly drops below the detection voltage $-V_{DET}$, the output voltage returns to its low level. In this state, the through-type current -- and its resultant voltage drop -- have disappeared, and the output goes back from low to high. Again, a through-type current is generated, a voltage drop appears, and the process repeats. Oscillation refers to this unstable condition.

- Power reset mis-implementation
- Mis-implementation with input voltage divider

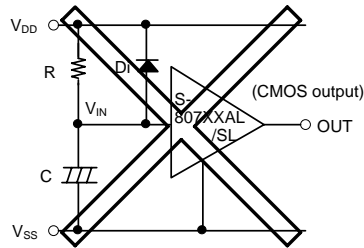

Figure 11

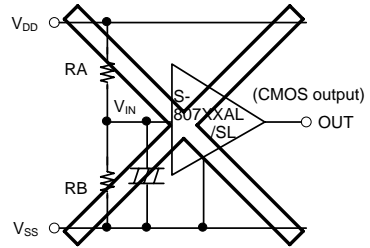

Figure 12

HIGH-PRECISION VOLTAGE DETECTOR

S-807 Series

■ Operation

1. Basic operation

- (1) When power supply voltage V_{DD} is greater than the release voltage $+V_{DET}$, the Nch transistor is OFF and the Pch transistor ON, causing V_{DD} (high) to appear at the output. With the Nch transistor of Figure 13 (a) off, the comparator input voltage is $(RB+RC)/(RA+RB+RC) \times V_{DD}$.
- (2) When power supply voltage V_{DD} goes below $+V_{DET}$, the output continues to maintain the power supply voltage level, as long as V_{DD} remains above the detection voltage $-V_{DET}$. When V_{DD} does fall below $-V_{DET}$ (A in Figure 14), the Nch transistor goes ON, the Pch transistor goes OFF, and V_{SS} appears at the output. With the Nch transistor of Figure 13 (a) ON, the comparator input voltage is $RB/(RA+RB) \times V_{DD}$.
- (3) When V_{DD} falls below the minimum operating voltage, the output becomes undefined. However, output will revert to V_{DD} if a pull-up has been employed.
- (4) V_{SS} will again be output when V_{DD} rises above the minimum operating voltage. V_{SS} will continue to be output even when V_{DD} surpasses $-V_{DET}$, as long as it does not exceed the release voltage $+V_{DET}$.
- (5) When V_{DD} rises above $+V_{DET}$ (B in Figure 14), the Nch transistor goes OFF, the Pch transistor goes ON, and V_{DD} appears at the output.

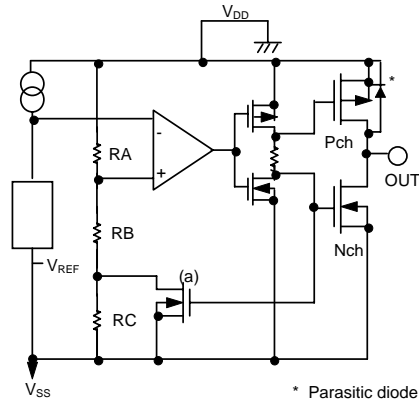

Figure 13

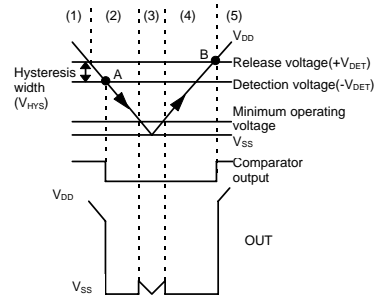

Figure 14

2. Reference voltage circuit

The S-807 Series has 0.8 V typical reference voltage circuit as V_{REF} (a high-stable reference voltage source) .

It features:

- Low power consumption
- Good temperature characteristic

3. Comparator

The comparator drives a differential amplifier with a current consumption of only 0.5 μ A as shown in Figure 15.

It features:

- Good matching characteristics
- Wide operating voltage range
- Low offset voltage

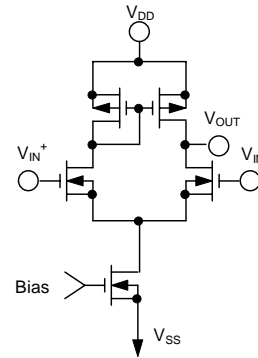

Figure 15 Comparator

4. Other characteristics

(1) Temperature characteristic of detection voltage

Because of the excellent temperature characteristic of the reference voltage circuit, the temperature characteristics of the detection voltage are expressed by the following formula in the range of -30°C to +80°C.

$$\frac{-V_{DET}}{-V_{REF}} \times (\pm 0.1) \text{ mV}/^\circ\text{C} \quad \text{typ.}$$

* $-V_{REF}$ is 0.65 V min., 0.8 V typ., 0.95 V max.

(2) Temperature characteristic of release voltage

$$\frac{-V_{DET} + V_{HYS}}{-V_{REF}} \times (\pm 0.1) \text{ mV}/^\circ\text{C}$$

HIGH-PRECISION VOLTAGE DETECTOR
S-807 Series

■ **Dimensions**

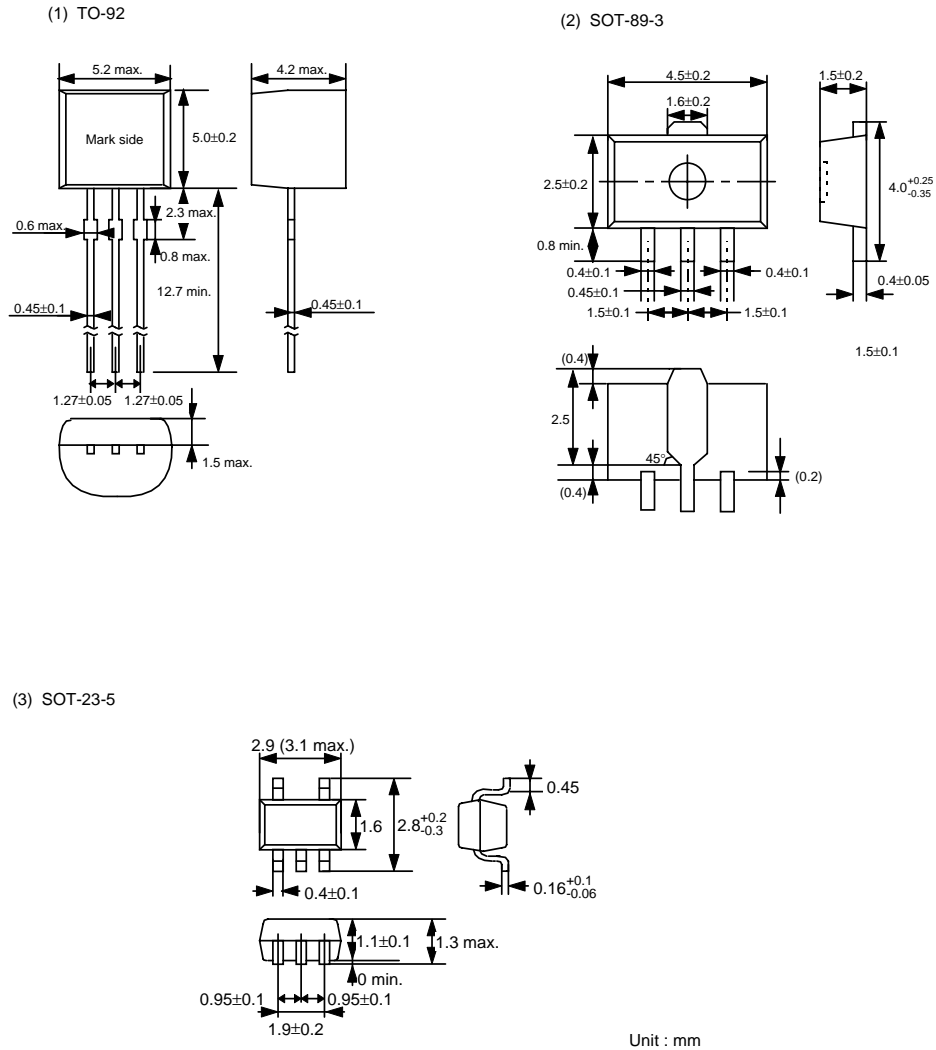

Figure 16 Dimensions

■ Taping

1. SOT-89-3

1.1 Tape specifications

T1 and T2 types are available depending upon the direction of ICs on the tape.

(1) White label (without a hole in the center of embossed area)

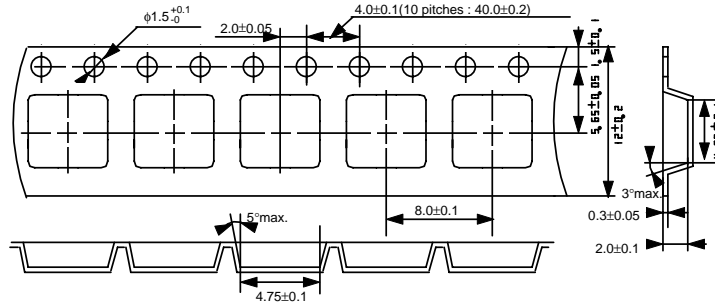

(2) Blue label (with a hole in the center of embossed area)

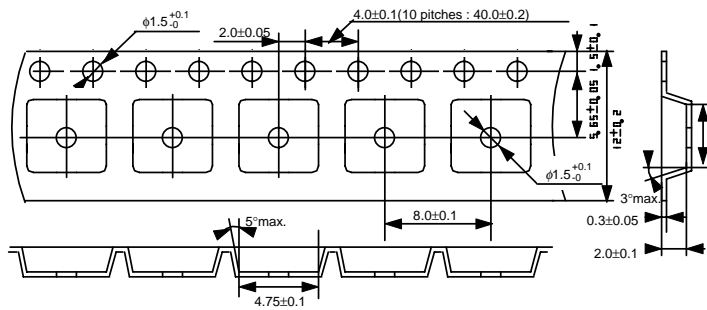

Unit : mm

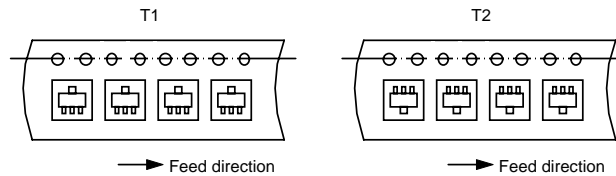

Figure 17

2.2. Reel specifications
1 reel holds 3000 detectors.

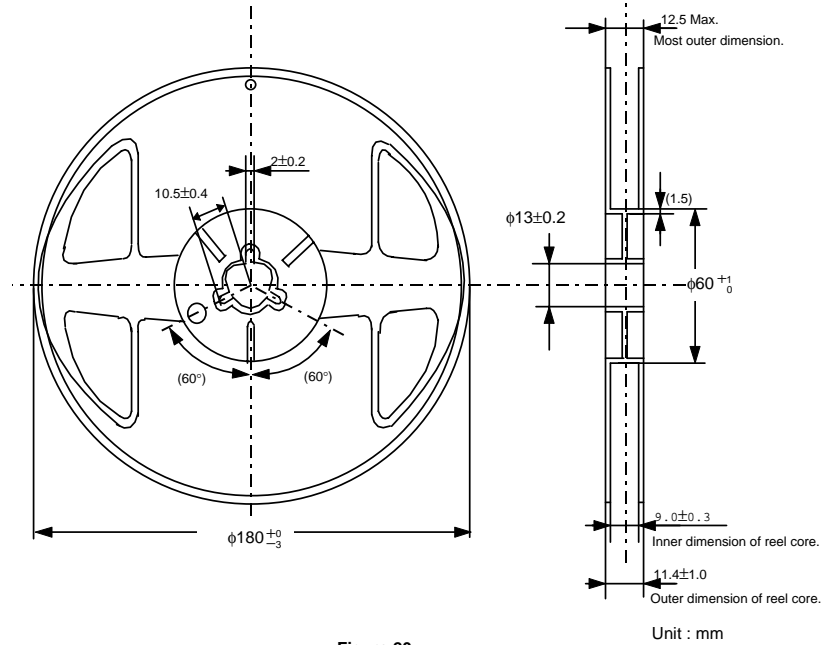

Figure 20

■ Magazine Dimensions
1 stick holds 25 detectors.

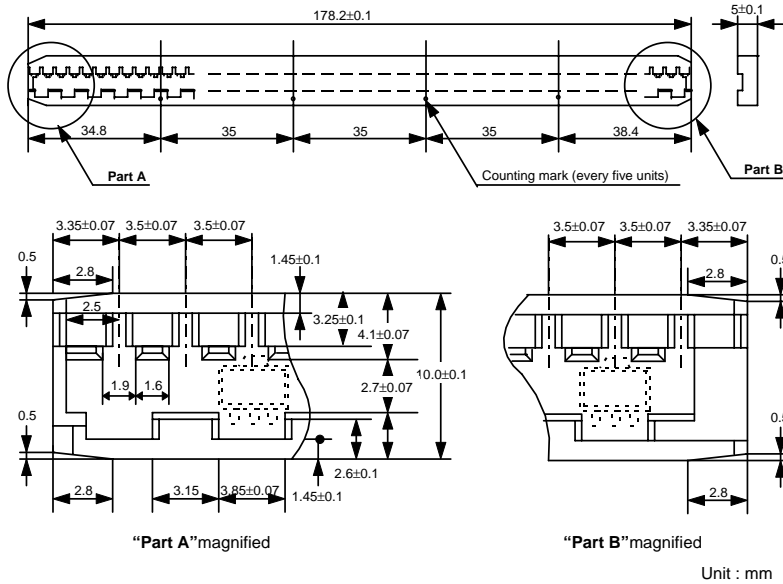
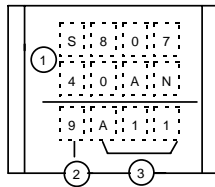

Figure 21

HIGH-PRECISION VOLTAGE DETECTOR
S-807 Series

■ **Markings**

1. TO-92



- ① Product name
- ② Last digit of the year
- ③ Lot No.

2. SOT-89-3

(1) White label

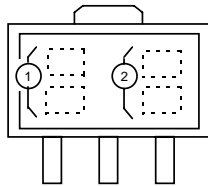

- ① Product name (abbreviation)
- ② Lot No.

(2) Blue label

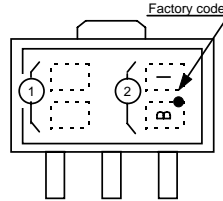

- ① Product name (abbreviation)
- ② Lot No.

3. SOT-23-5

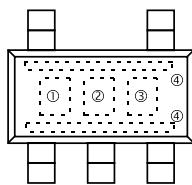

- ①&② Product name (abbreviation)
- ③&④ Lot No.
- ③: Alphabet
- ④: Dot on one side

Figure 22

■ Characteristics

1. Detection voltage (V_{DET}) - Temperature (T_a)

1.1 S-80730AL

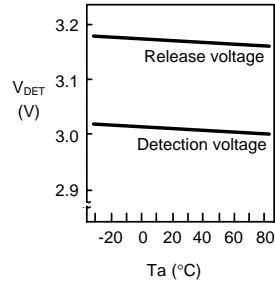

1.2 S-80740AH

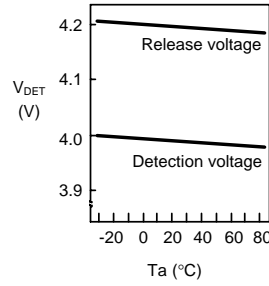

2. Current consumption (I_{SS}) - Input voltage (V_{IN})

2.1 S-80730AL

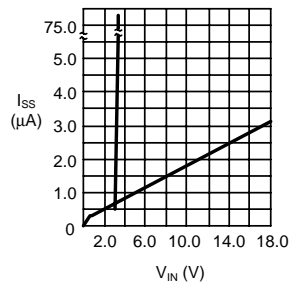

2.2 S-80740AH

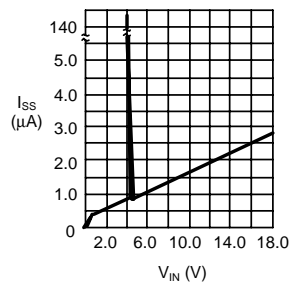

3. Current consumption (I_{SS}) - Temperature (T_a)

3.1 S-80730AL

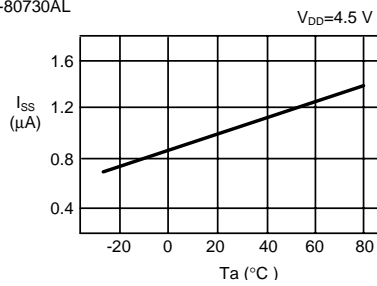

3.2 S-80740AH

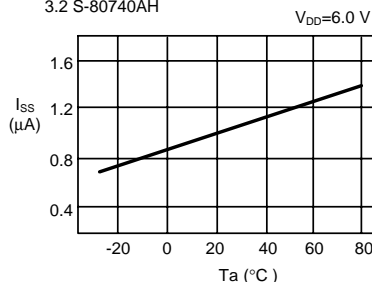

HIGH-PRECISION VOLTAGE DETECTOR
S-807 Series

4. Output transistor current (I_{OUT})

4.1 Nch transistor current

(i) V_{DS} - I_{OUT}

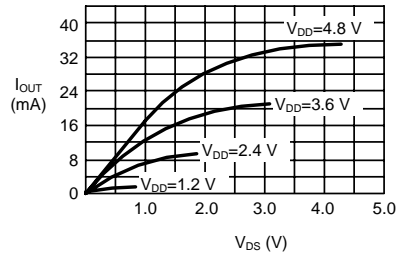

(ii) V_{DD} - I_{OUT}

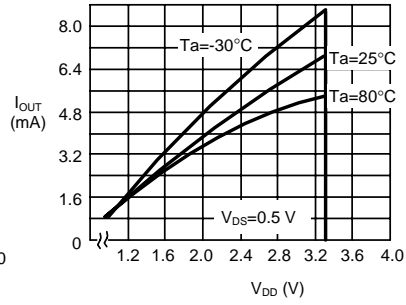

4.2 Pch transistor current

V_{DS} - I_{OUT}

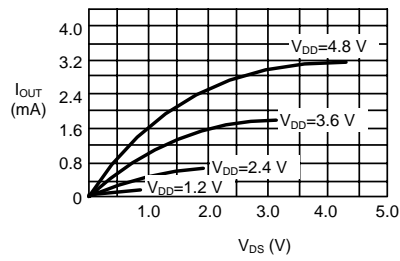

5. Minimum operating voltage

5.1 CMOS active low output

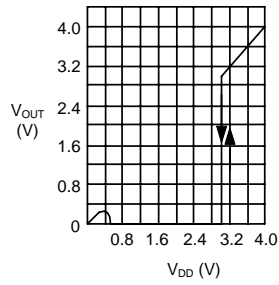

5.2 CMOS active high output

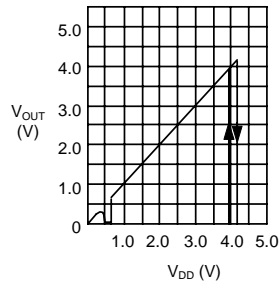

6. Dynamic response

6.1 Nch open-drain output products

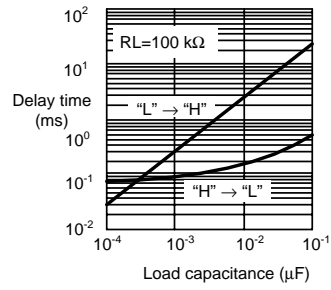

6.2 CMOS active low output products

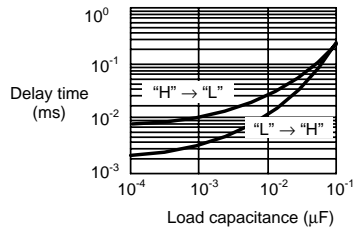

6.3 CMOS active high output products

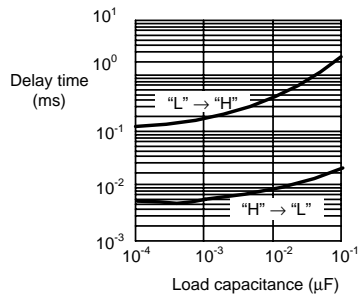

HIGH-PRECISION VOLTAGE DETECTOR

S-807 Series

Measuring Circuits

(1) Detection voltage

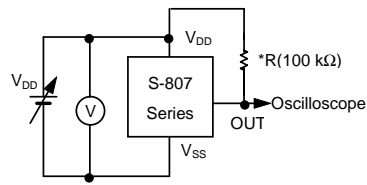

* R is unnecessary for CMOS output products.

(2) Current consumption

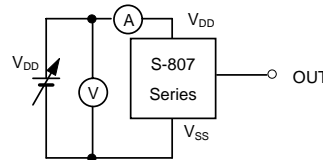

(3) Output transistor current

(a) Nch transistor current

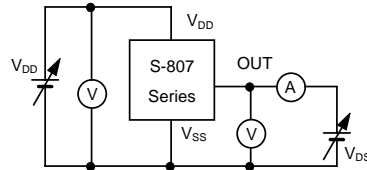

(b) Pch transistor current

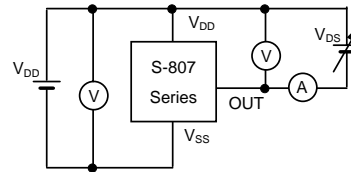

(4) Min. operating voltage

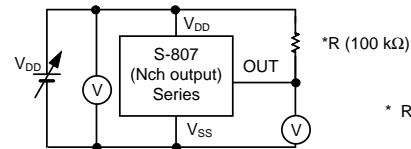

* R is unnecessary for CMOS output products.

(5) Dynamic response

(a) Nch open-drain output products

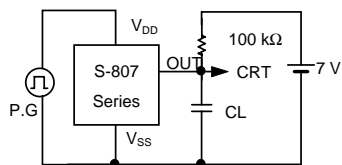

(b) CMOS output products

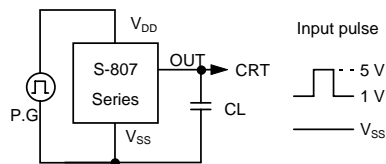

Figure 23

■ **Application Circuit Examples**

1. Reset circuits of microcomputers

If the power supply voltage to a microcomputer falls below the specified level, unspecified operation may be performed or the contents of the memory register may be lost. When power supply voltage returns to normal, the microcomputer may need to be initialized before normal operations can be done.

Reset circuits protect microcomputers, in the event of current being momentarily switched off or lowered. With the S-807 Series, the reset circuits shown in Figures 24 to 26 can be easily constructed.

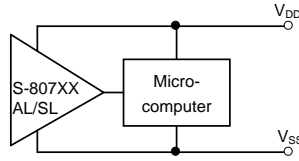
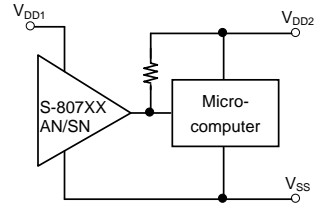

Figure 24



(Nch open-drain output products only)

Figure 25

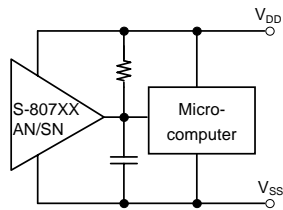
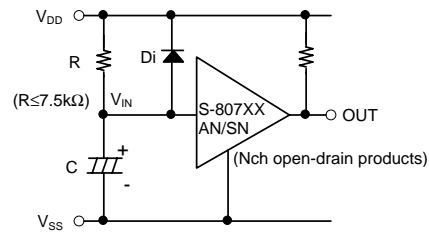

Figure 26

HIGH-PRECISION VOLTAGE DETECTOR S-807 Series

2. Power-on reset circuit

The Nch open-drain output products of the S-807 Series can be used to construct a power-on reset circuit. Following is an example.



Note 1: R should be 7.5kΩ or less for purpose of protection against oscillation.

Note 2: "Di" momentarily discharges the charge received via "C" at the falling edge of power off. There is no need to insert a diode, when there is no conflict with application circuit even if there is a delay in the falling edge of OUT at the falling edge of power off.

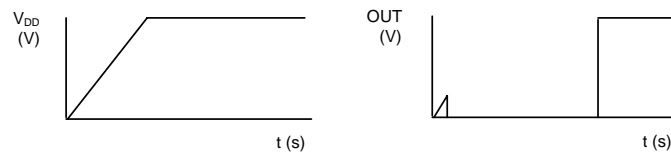

Figure 27

Note 3: When there is a sharp rise in power, the output voltage may go "H" momentarily in unstable range of the output voltage (the output voltage is unstable below the minimum operating voltage) .

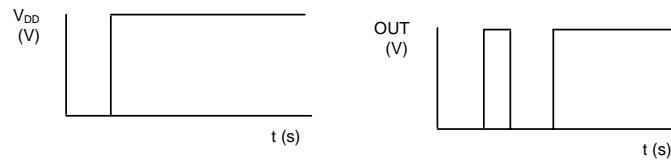
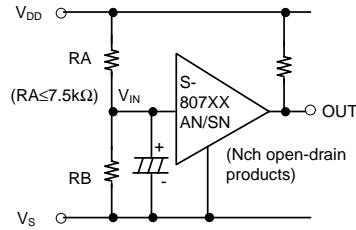

Figure 28

3. Change of detection voltage

In Nch open-drain output products of the S-807 Series, detection voltage can be changed with resistance dividers or diodes as shown in Figures 29 and 30. In Figure 29, hysteresis width is also changed.



$$\text{Detection voltage} = \frac{RA+RB}{RB} \bullet V_{DET}$$

$$\text{Hysteresis width} = \frac{RA+RB}{RB} \bullet V_{HYS}$$

Note 1: The hysteresis width will be a little wider than the value of the formula above, because of the through current, if RA and RB are larger.

Note 2: RA should be 7.5kΩ or less for purpose of protection against oscillation.

Figure 29

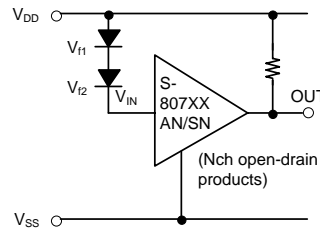

$$\text{Detection voltage} = V_{11} + V_{12} + V_{DET}$$

Figure 30

■ Notes

- In CMOS output products of S-807 Series, high through current flows when detecting or releasing. If a high impedance is connected to the input, oscillation may be caused by the through current when lowering the voltage during releasing.
- In TO-92 products, since there are projections and resin burrs on the roots of the lead terminals formed at the Tiebar-cut, do not solder to them.
- When designing for mass production using an application circuit described here, take into account the deviation of components and temperature characteristics.
- Seiko Instruments Inc. cannot take any responsibility for the patents on the circuits described here.

Collection of Product FAQs

Author: Hamaguchi Masanao

Date: 98/11/12 (Thursday) 10:17 (Modified: 98/12/14 (Monday) 16:42)

<Information level>

A: Public (Printing O.K.)

Index: B: Technical

<Product>

Division name: 01 IC

Category 1: 11 Power Supply

Category 2: 1. Voltage Detectors

Cal No.: S-807

Related Documents:

Question:

What is the method for calculating delay-time of the power-on clear circuit?

Answer:

The delay time (power-on clear time) produced in a power-on clear circuit using the S-807xxAN can be found by substituting constants in the following formula:

$$T_{\text{delay}} = 1 \times C \times R \times \ln\left(1 - \frac{V_{\text{det+}}}{V_{\text{dd}}}\right)$$

Tdelay: Delay time [sec]

C: External capacitance value [F]

R: Resistance value [Ω]

V det+: S-807xxAN Series release voltage [V]

Vdd: Supply voltage [V]

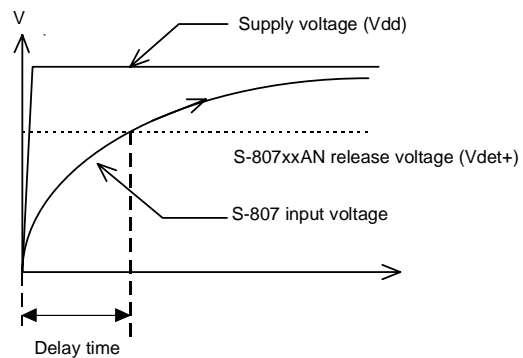
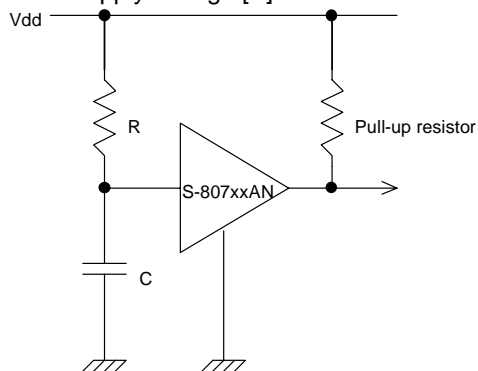

Note: Set R to less than 7.5 k Ω to prevent oscillation.

<Remarks>

FAQ No.: 11S807001