

# LMH6642/LMH6643/LMH6644

## Low Power, 130MHz, 75mA Rail-to-Rail Output Amplifiers

### General Description

The LMH664X family true single supply voltage feedback amplifiers offer high speed (130MHz), low distortion (-62dBc), and exceptionally high output current (approximately 75mA) at low cost and with reduced power consumption when compared against existing devices with similar performance.

Input common mode voltage range extends to 0.5V below  $V^-$  and 1V from  $V^+$ . Output voltage range extends to within 40mV of either supply rail, allowing wide dynamic range especially desirable in low voltage applications. The output stage is capable of approximately 75mA in order to drive heavy loads. Fast output Slew Rate (130V/ $\mu$ s) ensures large peak-to-peak output swings can be maintained even at higher speeds, resulting in exceptional full power bandwidth of 40MHz with a 3V supply. These characteristics, along with low cost, are ideal features for a multitude of industrial and commercial applications.

Careful attention has been paid to ensure device stability under all operating voltages and modes. The result is a very well behaved frequency response characteristic (0.1dB gain flatness up the 12MHz under 150 $\Omega$  load and  $A_V = +2$ ) with minimal peaking (typically 2dB maximum) for any gain setting and under both heavy and light loads. This along with fast settling time (68ns) and low distortion allows the device to operate well in ADC buffer, and high frequency filter applications as well as other applications.

This device family offers professional quality video performance with low DG (0.01%) and DP (0.01 $^\circ$ ) characteristics. Differential Gain and Differential Phase characteristics are also well maintained under heavy loads (150 $\Omega$ ) and throughout the output voltage range. The LMH664X family is offered

in single (LMH6642), dual (LMH6643), and quad (LMH6644) options. See ordering information for packages offered.

### Features

( $V_S = \pm 5V$ ,  $T_A = 25^\circ C$ ,  $R_L = 2k\Omega$ ,  $A_V = +1$ . Typical values unless specified).

- -3dB BW ( $A_V = +1$ ) 130MHz
- Supply voltage range 2.7V to 12.8V
- Slew rate (Note 8), ( $A_V = -1$ ) 130V/ $\mu$ s
- Supply current (no load) 2.7mA/amp
- Output short circuit current +115mA/-145mA
- Linear output current  $\pm 75$ mA
- Input common mode volt. 0.5V beyond  $V^-$ , 1V from  $V^+$
- Output voltage swing 40mV from rails
- Input voltage noise (100kHz) 17nV/ $\sqrt{Hz}$
- Input current noise (100kHz) 0.9pA/ $\sqrt{Hz}$
- THD (5MHz,  $R_L = 2k\Omega$ ,  $V_O = 2V_{PP}$ ,  $A_V = +2$ ) -62dBc
- Settling time 68ns
- Fully characterized for 3V, 5V, and  $\pm 5V$
- Overdrive recovery 100ns
- Output short circuit protected (Note 11)
- No output phase reversal with CMVR exceeded

### Applications

- Active filters
- CD/DVD ROM
- ADC buffer amp
- Portable video
- Current sense buffer

Closed Loop Gain vs. Frequency for Various Gain

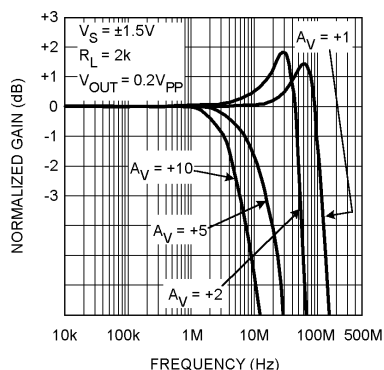

20018535

Large Signal Frequency Response

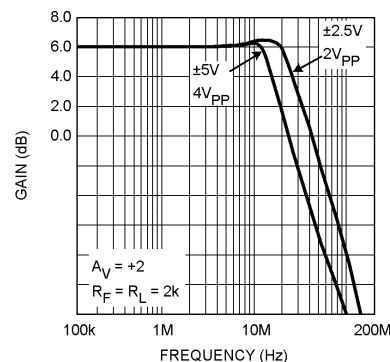

20018547

**Absolute Maximum Ratings** (Note 1)

If Military/Aerospace specified devices are required, please contact the National Semiconductor Sales Office/Distributors for availability and specifications.

ESD Tolerance	2KV (Note 2)
	200V (Note 9)
$V_{IN}$ Differential	$\pm 2.5V$
Output Short Circuit Duration	(Note 3), (Note 11)
Supply Voltage ( $V^+ - V^-$ )	13.5V
Voltage at Input/Output pins	$V^+ +0.8V, V^- -0.8V$
Input Current	$\pm 10mA$
Storage Temperature Range	$-65^\circ C$ to $+150^\circ C$
Junction Temperature (Note 4)	$+150^\circ C$
Soldering Information	

Infrared or Convection Reflow(20 sec) 235°C

Wave Soldering Lead Temp.(10 sec) 260°C

**Operating Ratings** (Note 1)

Supply Voltage ( $V^+ - V^-$ )	2.7V to 12.8V
Junction Temperature Range (Note 4)	$-40^\circ C$ to $+85^\circ C$
Package Thermal Resistance (Note 4) ( $\theta_{JA}$ )	
SOT23-5	265°C/W
SOIC-8	190°C/W
MSOP-8	235°C/W
SOIC-14	145°C/W
TSSOP-14	155°C/W

**3V Electrical Characteristics**

Unless otherwise specified, all limits guaranteed for at  $T_J = 25^\circ C$ ,  $V^+ = 3V$ ,  $V^- = 0V$ ,  $V_{CM} = V_O = V^+/2$ , and  $R_L = 2k\Omega$  to  $V^+/2$ . **Boldface** limits apply at the temperature extremes.

Symbol	Parameter	Conditions	Min (Note 6)	Typ (Note 5)	Max (Note 6)	Units
BW	-3dB BW	$A_V = +1, V_{OUT} = 200mV_{PP}$	80	115		MHz
		$A_V = +2, -1, V_{OUT} = 200mV_{PP}$		46		
$BW_{0.1dB}$	0.1dB Gain Flatness	$A_V = +2, R_L = 150\Omega$ to $V^+/2$ , $R_L = 402\Omega, V_{OUT} = 200mV_{PP}$		19		MHz
PBW	Full Power Bandwidth	$A_V = +1, -1dB, V_{OUT} = 1V_{PP}$		40		MHz
$e_n$	Input-Referred Voltage Noise	$f = 100kHz$		17		$nV/\sqrt{Hz}$
		$f = 1kHz$		48		
$i_n$	Input-Referred Current Noise	$f = 100kHz$		0.90		$pA/\sqrt{Hz}$
		$f = 1kHz$		3.3		
THD	Total Harmonic Distortion	$f = 5MHz, V_O = 2V_{PP}, A_V = -1,$ $R_L = 100\Omega$ to $V^+/2$		-48		dBc
DG	Differential Gain	$V_{CM} = 1V, NTSC, A_V = +2$ $R_L = 150\Omega$ to $V^+/2$		0.17		%
		$R_L = 1k\Omega$ to $V^+/2$		0.03		
DP	Differential Phase	$V_{CM} = 1V, NTSC, A_V = +2$ $R_L = 150\Omega$ to $V^+/2$		0.05		deg
		$R_L = 1k\Omega$ to $V^+/2$		0.03		
CT Rej.	Cross-Talk Rejection	$f = 5MHz, \text{Receiver:}$ $R_f = R_g = 510\Omega, A_V = +2$		47		dB
$T_S$	Settling Time	$V_O = 2V_{PP}, \pm 0.1\%, 8pF$ Load, $V_S = 5V$		68		ns
SR	Slew Rate (Note 8)	$A_V = -1, V_I = 2V_{PP}$	90	120		V/ $\mu s$
$V_{OS}$	Input Offset Voltage			$\pm 1$	$\pm 5$ <b><math>\pm 7</math></b>	mV
TC $V_{OS}$	Input Offset Average Drift	(Note 12)		$\pm 5$		$\mu V/^\circ C$
$I_B$	Input Bias Current	(Note 7)		-1.50	-2.60 <b>-3.25</b>	$\mu A$
$I_{OS}$	Input Offset Current			20	800 <b>1000</b>	nA
$R_{IN}$	Common Mode Input Resistance			3		M $\Omega$
$C_{IN}$	Common Mode Input Capacitance			2		pF

### 3V Electrical Characteristics (Continued)

Unless otherwise specified, all limits guaranteed for at  $T_J = 25^\circ\text{C}$ ,  $V^+ = 3\text{V}$ ,  $V^- = 0\text{V}$ ,  $V_{\text{CM}} = V_O = V^+/2$ , and  $R_L = 2\text{k}\Omega$  to  $V^+/2$ .

**Boldface** limits apply at the temperature extremes.

Symbol	Parameter	Conditions	Min (Note 6)	Typ (Note 5)	Max (Note 6)	Units
CMVR	Input Common-Mode Voltage Range	CMRR $\geq 50\text{dB}$		-0.5	-0.2	V
			1.8 <b>1.6</b>	2.0	<b>-0.1</b>	
CMRR	Common Mode Rejection Ratio	$V_{\text{CM}}$ Stepped from 0V to 1.5V	72	95		dB
$A_{\text{VOL}}$	Large Signal Voltage Gain	$V_O = 0.5\text{V}$ to 2.5V $R_L = 2\text{k}\Omega$ to $V^+/2$	80 <b>75</b>	96		dB
		$V_O = 0.5\text{V}$ to 2.5V $R_L = 150\Omega$ to $V^+/2$	74 <b>70</b>	82		
$V_O$	Output Swing High	$R_L = 2\text{k}\Omega$ to $V^+/2$ , $V_{\text{ID}} = 200\text{mV}$	2.90	2.98		V
		$R_L = 150\Omega$ to $V^+/2$ , $V_{\text{ID}} = 200\text{mV}$	2.80	2.93		
	Output Swing Low	$R_L = 2\text{k}\Omega$ to $V^+/2$ , $V_{\text{ID}} = -200\text{mV}$		25	75	mV
		$R_L = 150\Omega$ to $V^+/2$ , $V_{\text{ID}} = -200\text{mV}$		75	150	
$I_{\text{SC}}$	Output Short Circuit Current	Sourcing to $V^+/2$ $V_{\text{ID}} = 200\text{mV}$ (Note 10)	50 <b>35</b>	95		mA
		Sinking to $V^+/2$ $V_{\text{ID}} = -200\text{mV}$ (Note 10)	55 <b>40</b>	110		
$I_{\text{OUT}}$	Output Current	$V_{\text{OUT}} = 0.5\text{V}$ from either supply		$\pm 65$		mA
+PSRR	Positive Power Supply Rejection Ratio	$V^+ = 3.0\text{V}$ to 3.5V, $V_{\text{CM}} = 1.5\text{V}$	75	85		dB
$I_S$	Supply Current (per channel)	No Load		2.70	4.00 <b>4.50</b>	mA

### 5V Electrical Characteristics

Unless otherwise specified, all limits guaranteed for at  $T_J = 25^\circ\text{C}$ ,  $V^+ = 5\text{V}$ ,  $V^- = 0\text{V}$ ,  $V_{\text{CM}} = V_O = V^+/2$ , and  $R_L = 2\text{k}\Omega$  to  $V^+/2$ .

**Boldface** limits apply at the temperature extremes.

Symbol	Parameter	Conditions	Min (Note 6)	Typ (Note 5)	Max (Note 6)	Units
BW	-3dB BW	$A_V = +1$ , $V_{\text{OUT}} = 200\text{mV}_{\text{PP}}$	90	120		MHz
		$A_V = +2, -1$ , $V_{\text{OUT}} = 200\text{mV}_{\text{PP}}$		46		
$BW_{0.1\text{dB}}$	0.1dB Gain Flatness	$A_V = +2$ , $R_L = 150\Omega$ to $V^+/2$ , $R_f = 402\Omega$ , $V_{\text{OUT}} = 200\text{mV}_{\text{PP}}$		15		MHz
PBW	Full Power Bandwidth	$A_V = +1$ , -1dB, $V_{\text{OUT}} = 2V_{\text{PP}}$		22		MHz
$e_n$	Input-Referred Voltage Noise	$f = 100\text{kHz}$		17		$\text{nV}/\sqrt{\text{Hz}}$
		$f = 1\text{kHz}$		48		
$i_n$	Input-Referred Current Noise	$f = 100\text{kHz}$		0.90		$\text{pA}/\sqrt{\text{Hz}}$
		$f = 1\text{kHz}$		3.3		
THD	Total Harmonic Distortion	$f = 5\text{MHz}$ , $V_O = 2V_{\text{PP}}$ , $A_V = +2$		-60		dBc
DG	Differential Gain	NTSC, $A_V = +2$ $R_L = 150\Omega$ to $V^+/2$		0.16		%
		$R_L = 1\text{k}\Omega$ to $V^+/2$		0.05		
DP	Differential Phase	NTSC, $A_V = +2$ $R_L = 150\Omega$ to $V^+/2$		0.05		deg
		$R_L = 1\text{k}\Omega$ to $V^+/2$		0.01		
CT Rej.	Cross-Talk Rejection	$f = 5\text{MHz}$ , Receiver: $R_f = R_g = 510\Omega$ , $A_V = +2$		47		dB
$T_S$	Settling Time	$V_O = 2V_{\text{PP}}$ , $\pm 0.1\%$ , 8pF Load		68		ns

**5V Electrical Characteristics** (Continued)

Unless otherwise specified, all limits guaranteed for at  $T_J = 25^\circ\text{C}$ ,  $V^+ = 5\text{V}$ ,  $V^- = 0\text{V}$ ,  $V_{\text{CM}} = V_O = V^+/2$ , and  $R_L = 2\text{k}\Omega$  to  $V^+/2$ . **Boldface** limits apply at the temperature extremes.

Symbol	Parameter	Conditions	Min (Note 6)	Typ (Note 5)	Max (Note 6)	Units
SR	Slew Rate (Note 8)	$A_V = -1$ , $V_I = 2V_{\text{PP}}$	95	125		V/ $\mu\text{s}$
$V_{\text{OS}}$	Input Offset Voltage			$\pm 1$	$\pm 5$ <b><math>\pm 7</math></b>	mV
TC $V_{\text{OS}}$	Input Offset Average Drift	(Note 12)		$\pm 5$		$\mu\text{V}/^\circ\text{C}$
$I_{\text{B}}$	Input Bias Current	(Note 7)		-1.70	-2.60 <b>-3.25</b>	$\mu\text{A}$
$I_{\text{OS}}$	Input Offset Current			20	800 <b>1000</b>	nA
$R_{\text{IN}}$	Common Mode Input Resistance			3		$\text{M}\Omega$
$C_{\text{IN}}$	Common Mode Input Capacitance			2		pF
CMVR	Input Common-Mode Voltage Range	CMRR $\geq 50\text{dB}$		-0.5	-0.2 <b>-0.1</b>	V
			3.8 <b>3.6</b>	4.0		
CMRR	Common Mode Rejection Ratio	$V_{\text{CM}}$ Stepped from 0V to 3.5V	72	95		dB
$A_{\text{VOL}}$	Large Signal Voltage Gain	$V_O = 0.5\text{V}$ to 4.50V $R_L = 2\text{k}\Omega$ to $V^+/2$	86 <b>82</b>	98		dB
		$V_O = 0.5\text{V}$ to 4.25V $R_L = 150\Omega$ to $V^+/2$	76 <b>72</b>	82		
$V_O$	Output Swing High	$R_L = 2\text{k}\Omega$ to $V^+/2$ , $V_{\text{ID}} = 200\text{mV}$	4.90	4.98		V
		$R_L = 150\Omega$ to $V^+/2$ , $V_{\text{ID}} = 200\text{mV}$	4.65	4.90		
$V_O$	Output Swing Low	$R_L = 2\text{k}\Omega$ to $V^+/2$ , $V_{\text{ID}} = -200\text{mV}$		25	100	mV
		$R_L = 150\Omega$ to $V^+/2$ , $V_{\text{ID}} = -200\text{mV}$		100	150	
$I_{\text{SC}}$	Output Short Circuit Current	Sourcing to $V^+/2$ $V_{\text{ID}} = 200\text{mV}$ (Note 10)	55 <b>40</b>	115		mA
		Sinking to $V^+/2$ $V_{\text{ID}} = -200\text{mV}$ (Note 10)	70 <b>55</b>	140		
$I_{\text{OUT}}$	Output Current	$V_O = 0.5\text{V}$ from either supply		$\pm 70$		mA
+PSRR	Positive Power Supply Rejection Ratio	$V^+ = 4.0\text{V}$ to 6V	79	90		dB
$I_{\text{S}}$	Supply Current (per channel)	No Load		2.70	4.25 <b>5.00</b>	mA

 **$\pm 5\text{V}$  Electrical Characteristics**

Unless otherwise specified, all limits guaranteed for at  $T_J = 25^\circ\text{C}$ ,  $V^+ = 5\text{V}$ ,  $V^- = -5\text{V}$ ,  $V_{\text{CM}} = V_O = 0\text{V}$  and  $R_L = 2\text{k}\Omega$  to ground. **Boldface** limits apply at the temperature extremes.

Symbol	Parameter	Conditions	Min (Note 6)	Typ (Note 5)	Max (Note 6)	Units
BW	-3dB BW	$A_V = +1$ , $V_{\text{OUT}} = 200\text{mV}_{\text{PP}}$	95	130		MHz
		$A_V = +2$ , -1, $V_{\text{OUT}} = 200\text{mV}_{\text{PP}}$		46		
$\text{BW}_{0.1\text{dB}}$	0.1dB Gain Flatness	$A_V = +2$ , $R_L = 150\Omega$ to $V^+/2$ , $R_f = 806\Omega$ , $V_{\text{OUT}} = 200\text{mV}_{\text{PP}}$		12		MHz
PBW	Full Power Bandwidth	$A_V = +1$ , -1dB, $V_{\text{OUT}} = 2V_{\text{PP}}$		24		MHz
$e_n$	Input-Referred Voltage Noise	$f = 100\text{kHz}$		17		nV/ $\sqrt{\text{Hz}}$
		$f = 1\text{kHz}$		48		

**±5V Electrical Characteristics** (Continued)

Unless otherwise specified, all limits guaranteed for at  $T_J = 25^\circ\text{C}$ ,  $V^+ = 5\text{V}$ ,  $V^- = -5\text{V}$ ,  $V_{CM} = V_O = 0\text{V}$  and  $R_L = 2\text{k}\Omega$  to ground. **Boldface** limits apply at the temperature extremes.

Symbol	Parameter	Conditions	Min (Note 6)	Typ (Note 5)	Max (Note 6)	Units
$i_n$	Input-Referred Current Noise	$f = 100\text{kHz}$		0.90		$\text{pA}/\sqrt{\text{Hz}}$
		$f = 1\text{kHz}$		3.3		
THD	Total Harmonic Distortion	$f = 5\text{MHz}$ , $V_O = 2V_{PP}$ , $A_V = +2$		-62		dBc
DG	Differential Gain	NTSC, $A_V = +2$ $R_L = 150\Omega$ to $V^+/2$		0.15		%
		$R_L = 1\text{k}\Omega$ to $V^+/2$		0.01		
DP	Differential Phase	NTSC, $A_V = +2$ $R_L = 150\Omega$ to $V^+/2$		0.04		deg
		$R_L = 1\text{k}\Omega$ to $V^+/2$		0.01		
CT Rej.	Cross-Talk Rejection	$f = 5\text{MHz}$ , Receiver: $R_f = R_g = 510\Omega$ , $A_V = +2$		47		dB
$T_S$	Settling Time	$V_O = 2V_{PP}$ , $\pm 0.1\%$ , 8pF Load, $V_S = 5\text{V}$		68		ns
SR	Slew Rate (Note 8)	$A_V = -1$ , $V_I = 2V_{PP}$	100	135		$\text{V}/\mu\text{s}$
$V_{OS}$	Input Offset Voltage			$\pm 1$	$\pm 5$ <b><math>\pm 7</math></b>	mV
TC $V_{OS}$	Input Offset Average Drift	(Note 12)		$\pm 5$		$\mu\text{V}/^\circ\text{C}$
$I_B$	Input Bias Current	(Note 7)		-1.60	-2.60 <b>-3.25</b>	$\mu\text{A}$
$I_{OS}$	Input Offset Current			20	800 <b>1000</b>	nA
$R_{IN}$	Common Mode Input Resistance			3		$\text{M}\Omega$
$C_{IN}$	Common Mode Input Capacitance			2		pF
CMVR	Input Common-Mode Voltage Range	CMRR $\geq 50\text{dB}$		-5.5	-5.2 <b>-5.1</b>	V
			3.8 <b>3.6</b>	4.0		
CMRR	Common Mode Rejection Ratio	$V_{CM}$ Stepped from $-5\text{V}$ to $3.5\text{V}$	74	95		dB
$A_{VOL}$	Large Signal Voltage Gain	$V_O = -4.5\text{V}$ to $4.5\text{V}$ , $R_L = 2\text{k}\Omega$	88 <b>84</b>	96		dB
		$V_O = -4.0\text{V}$ to $4.0\text{V}$ , $R_L = 150\Omega$	78 <b>74</b>	82		
$V_O$	Output Swing High	$R_L = 2\text{k}\Omega$ , $V_{ID} = 200\text{mV}$	4.90	4.96		V
		$R_L = 150\Omega$ , $V_{ID} = 200\text{mV}$	4.65	4.80		
	Output Swing Low	$R_L = 2\text{k}\Omega$ , $V_{ID} = -200\text{mV}$		-4.96	-4.90	V
		$R_L = 150\Omega$ , $V_{ID} = -200\text{mV}$		-4.80	-4.65	
$I_{SC}$	Output Short Circuit Current	Sourcing to Ground $V_{ID} = 200\text{mV}$ (Note 10)	60 <b>35</b>	115		mA
		Sinking to Ground $V_{ID} = -200\text{mV}$ (Note 10)	85 <b>65</b>	145		
$I_{OUT}$	Output Current	$V_O = 0.5\text{V}$ from either supply	$\pm 75$			mA
PSRR	Power Supply Rejection Ratio	$(V^+, V^-) = (4.5\text{V}, -4.5\text{V})$ to $(5.5\text{V}, -5.5\text{V})$	78	90		dB
$I_S$	Supply Current (per channel)	No Load		2.70	4.50 <b>5.50</b>	mA

## ±5V Electrical Characteristics (Continued)

**Note 1:** Absolute Maximum Ratings indicate limits beyond which damage to the device may occur. Operating Ratings indicate conditions for which the device is intended to be functional, but specific performance is not guaranteed. For guaranteed specifications and the test conditions, see the Electrical Characteristics.

**Note 2:** Human body model, 1.5kΩ in series with 100pF.

**Note 3:** Applies to both single-supply and split-supply operation. Continuous short circuit operation at elevated ambient temperature can result in exceeding the maximum allowed junction temperature of 150°C.

**Note 4:** The maximum power dissipation is a function of  $T_{J(MAX)}$ ,  $\theta_{JA}$ , and  $T_A$ . The maximum allowable power dissipation at any ambient temperature is  $P_D = (T_{J(MAX)} - T_A) / \theta_{JA}$ . All numbers apply for packages soldered directly onto a PC board.

**Note 5:** Typical values represent the most likely parametric norm.

**Note 6:** All limits are guaranteed by testing or statistical analysis.

**Note 7:** Positive current corresponds to current flowing into the device.

**Note 8:** Slew rate is the average of the rising and falling slew rates.

**Note 9:** Machine Model, 0Ω in series with 200pF.

**Note 10:** Short circuit test is a momentary test. See Note 11.

**Note 11:** Output short circuit duration is infinite for  $V_S < 6V$  at room temperature and below. For  $V_S > 6V$ , allowable short circuit duration is 1.5ms.

**Note 12:** Offset voltage average drift determined by dividing the change in  $V_{OS}$  at temperature extremes by the total temperature change.

## Connection Diagrams

SOT23-5 (LMH6642)

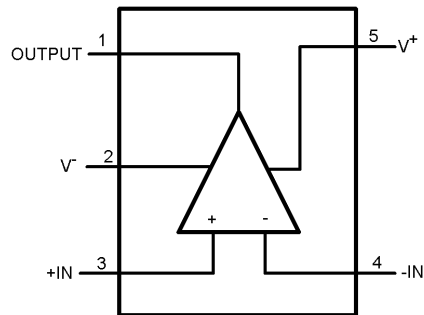

Top View

20018561

SOIC-8 (LMH6642)

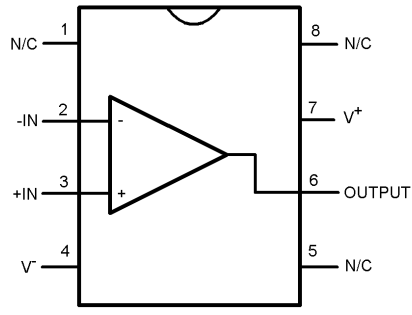

Top View

20018562

SOIC-8 and MSOP-8 (LMH6643)

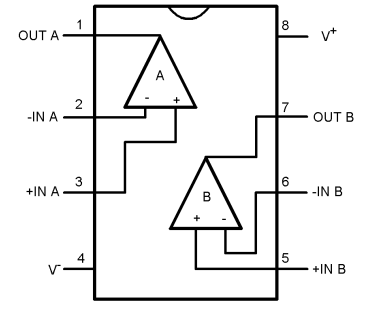

Top View

20018563

SOIC-14 and TSSOP-14 (LMH6644)

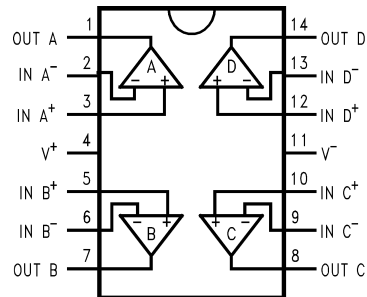

Top View

20018568

# Typical Performance Characteristics

At  $T_J = 25^\circ\text{C}$ ,  $V^+ = +5$ ,  $V^- = -5\text{V}$ ,  $R_F = R_L = 2\text{k}\Omega$ . Unless otherwise specified.

At  $T_J = 25^\circ\text{C}$ ,  $V^+ = +5$ ,  $V^- = -5\text{V}$ ,  $R_F = R_L = 2\text{k}\Omega$ . Unless otherwise specified.

Closed Loop Frequency Response for Various Supplies

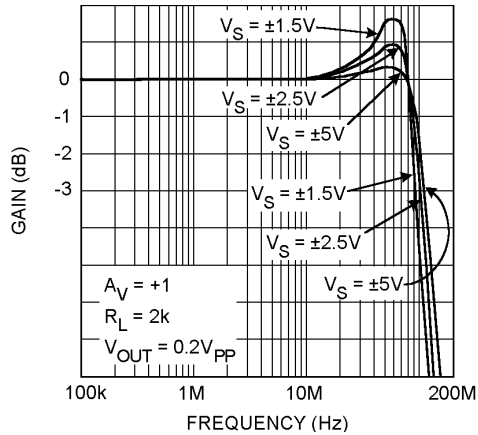

20018557

Closed Loop Gain vs. Frequency for Various Gain

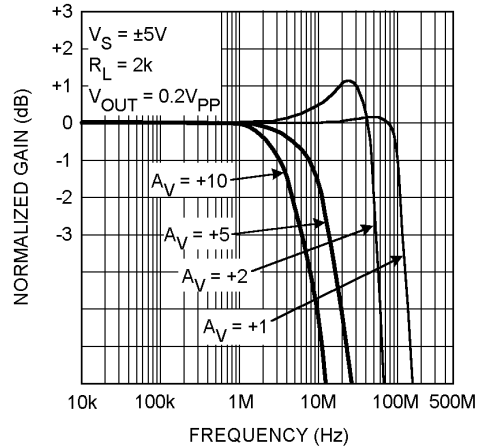

20018551

Closed Loop Gain vs. Frequency for Various Gain

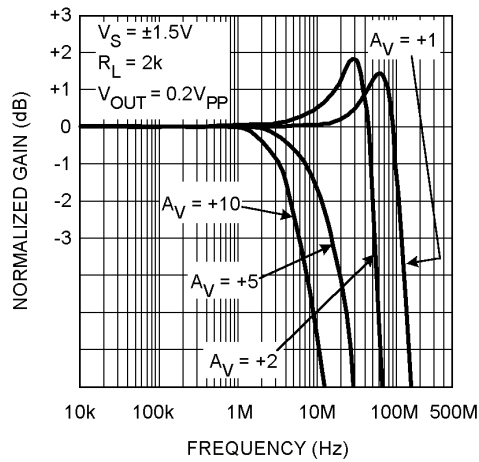

20018535

Closed Loop Frequency Response for Various Temperature

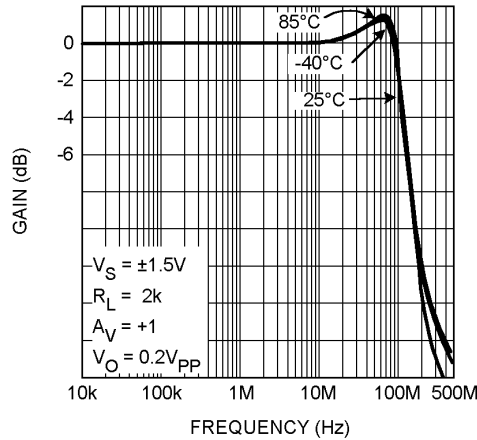

20018550

Closed Loop Gain vs. Frequency for Various Supplies

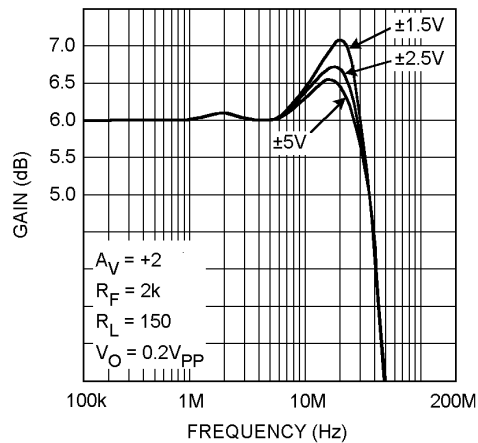

20018548

Closed Loop Frequency Response for Various Temperature

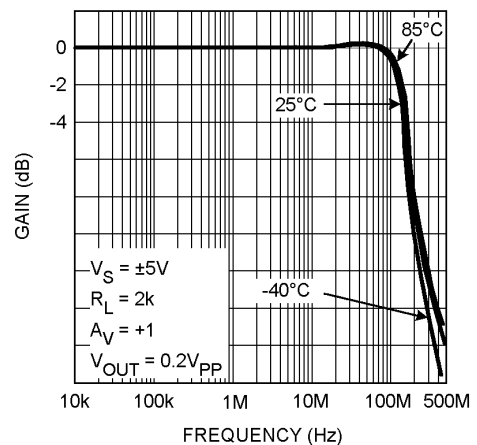

20018534

**Typical Performance Characteristics** At  $T_J = 25^\circ\text{C}$ ,  $V^+ = +5$ ,  $V^- = -5$ ,  $R_F = R_L = 2\text{k}\Omega$ . Unless otherwise specified. (Continued)

**Large Signal Frequency Response**

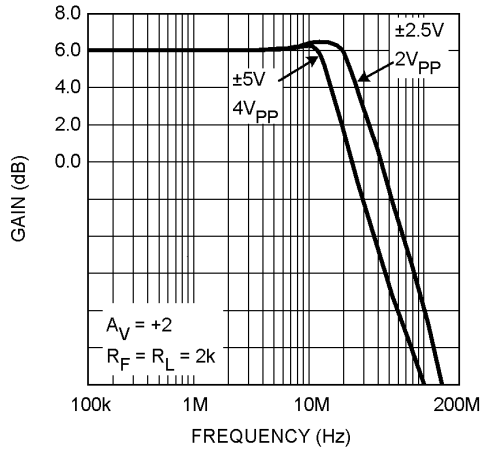

**Closed Loop Small Signal Frequency Response for Various Supplies**

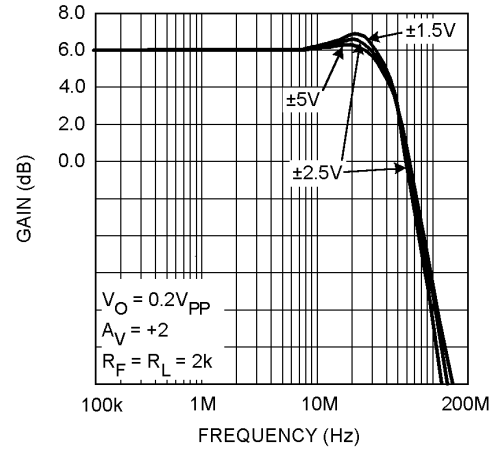

**Closed Loop Frequency Response for Various Supplies**

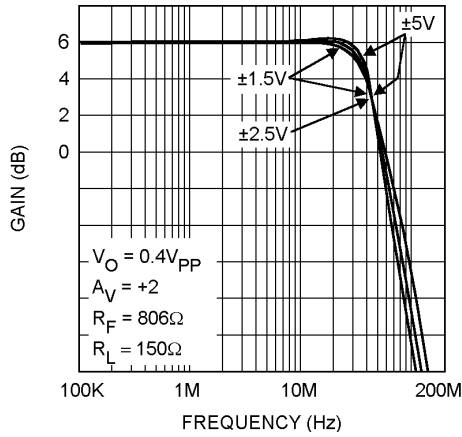

**±0.1dB Gain Flatness for Various Supplies**

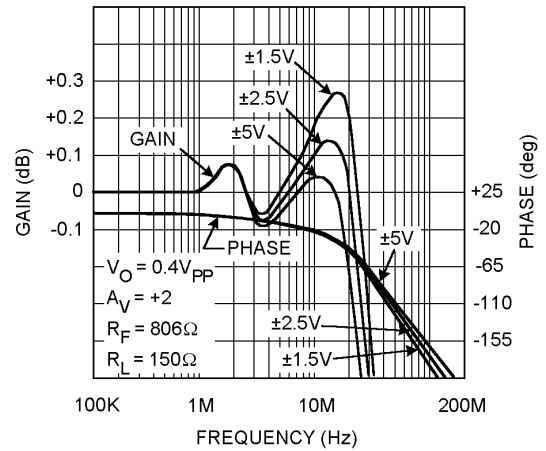

**$V_{OUT} (V_{PP})$  for THD < 0.5%**

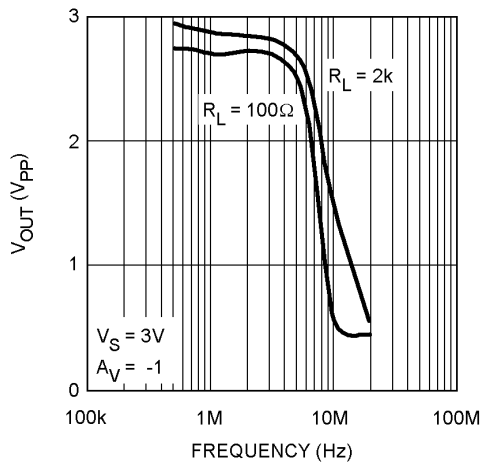

**$V_{OUT} (V_{PP})$  for THD < 0.5%**

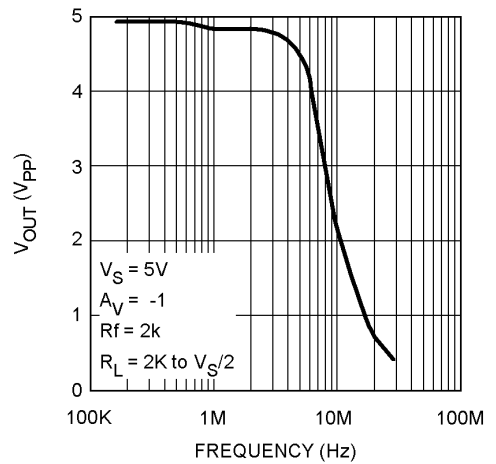



**Typical Performance Characteristics** At  $T_J = 25^\circ\text{C}$ ,  $V^+ = +5$ ,  $V^- = -5$ ,  $R_F = R_L = 2\text{k}\Omega$ . Unless otherwise specified. (Continued)

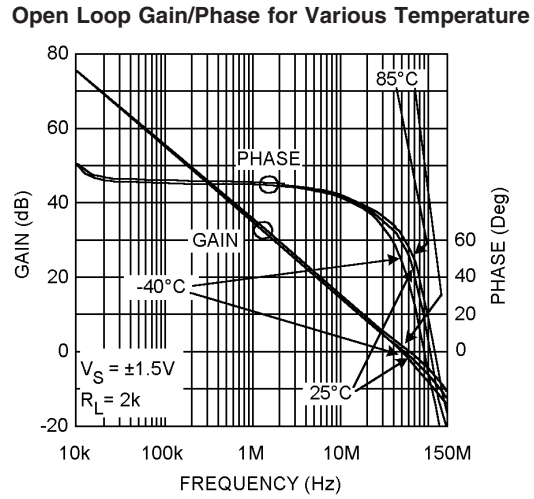
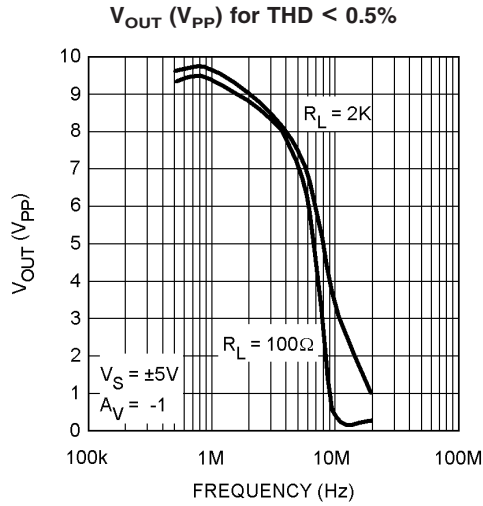

**Open Loop Gain/Phase for Various Temperature**

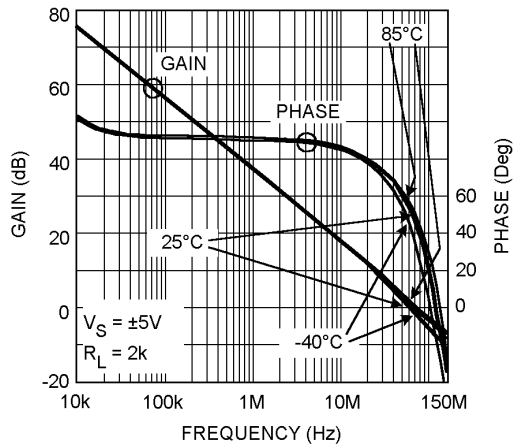

**HD2 (dBc) vs. Output Swing**

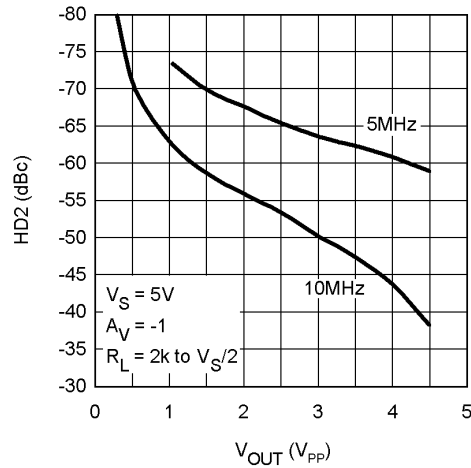

**HD3 (dBc) vs. Output Swing**

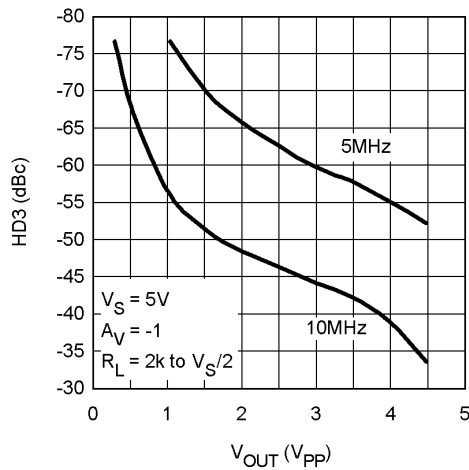

**HD2 vs. Output Swing**

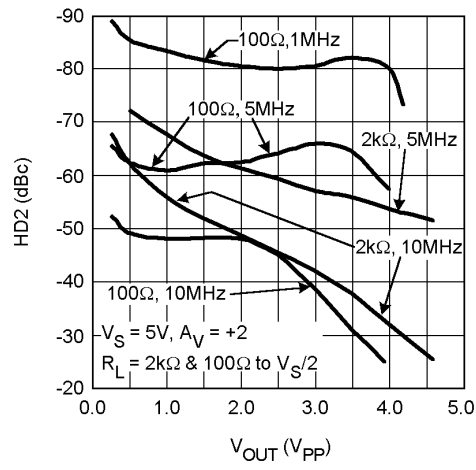

**Typical Performance Characteristics** At  $T_J = 25^\circ\text{C}$ ,  $V^+ = +5$ ,  $V^- = -5$ ,  $R_F = R_L = 2\text{k}\Omega$ . Unless otherwise specified. (Continued)

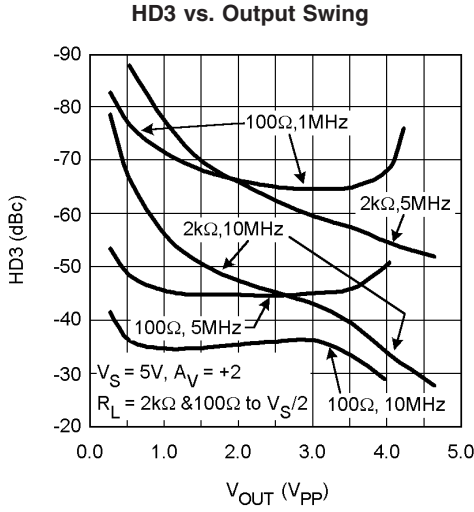

20018505

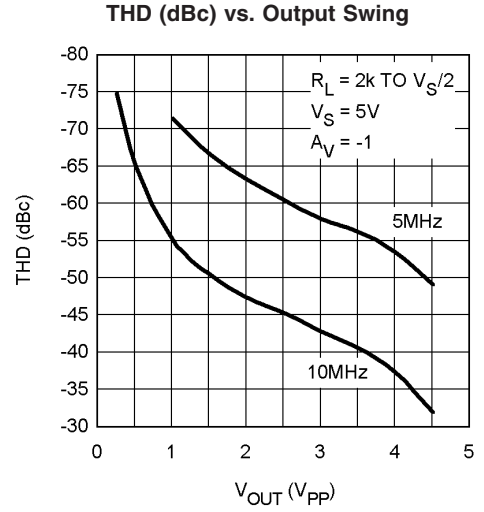

20018506

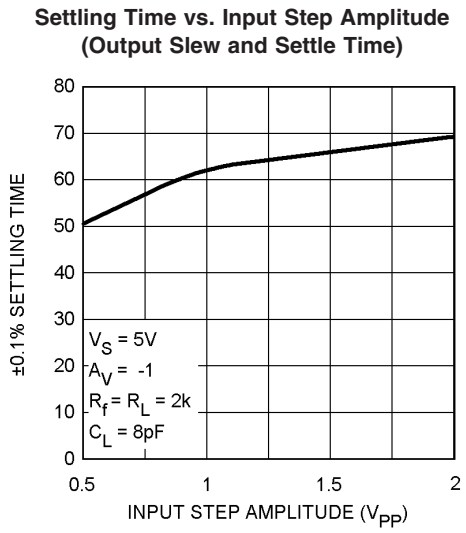

20018513

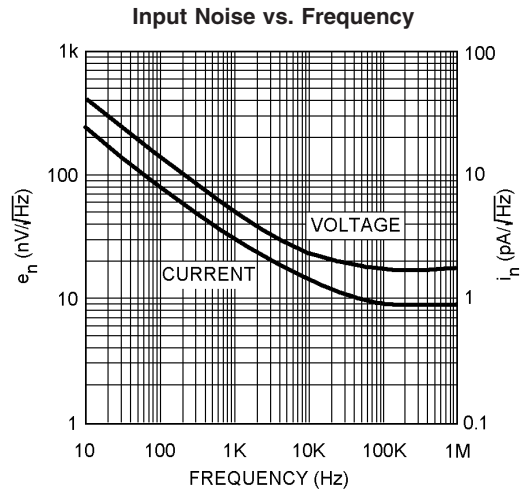

20018512

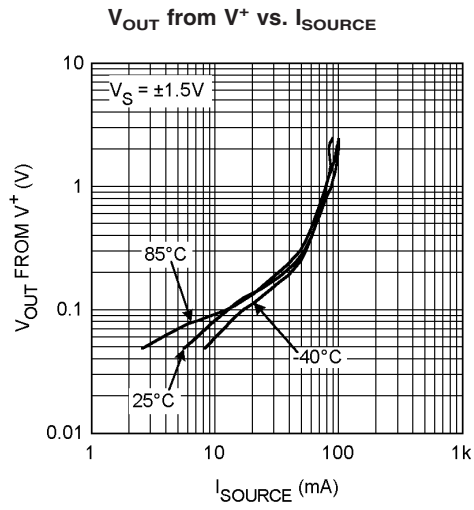

20018518

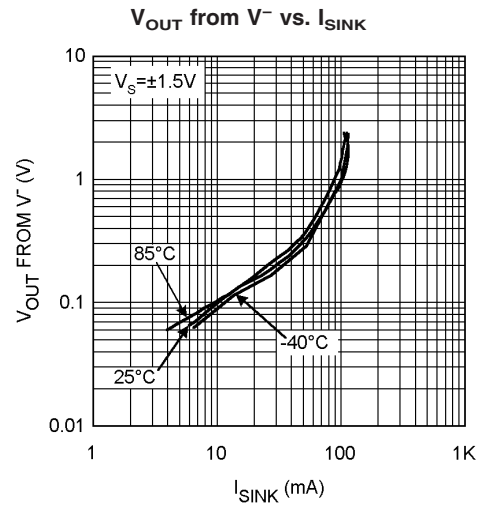

20018519

**Typical Performance Characteristics** At  $T_J = 25^\circ\text{C}$ ,  $V^+ = +5\text{V}$ ,  $V^- = -5\text{V}$ ,  $R_F = R_L = 2\text{k}\Omega$ . Unless otherwise specified. (Continued)

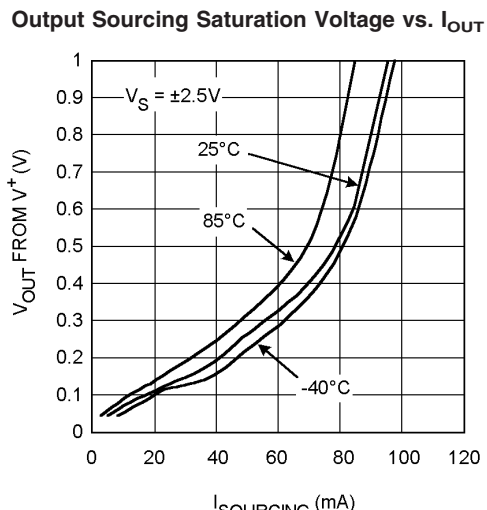
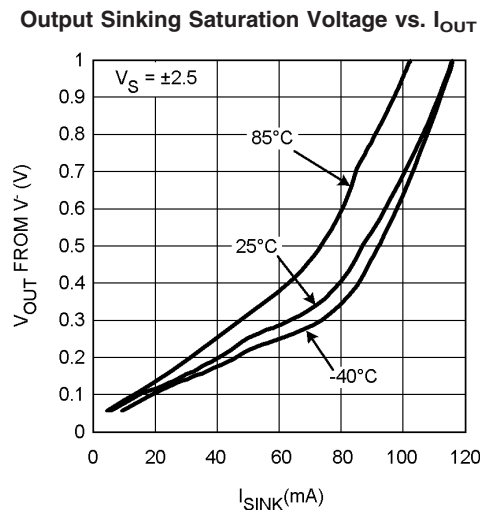
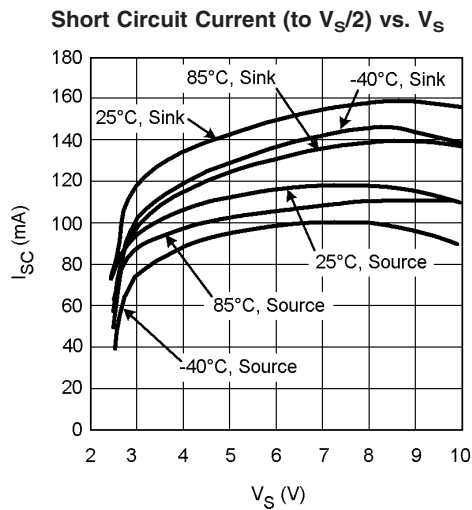
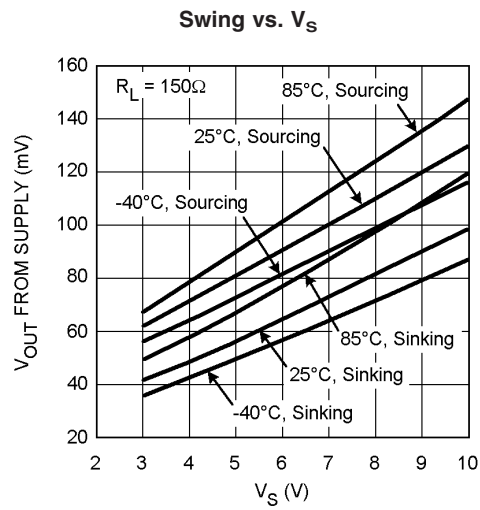
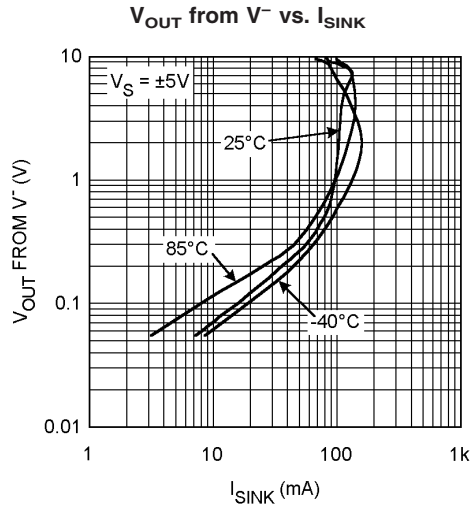
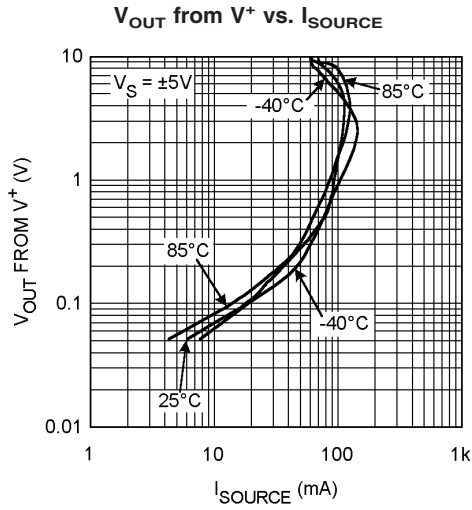

**Typical Performance Characteristics** At  $T_J = 25^\circ\text{C}$ ,  $V^+ = +5$ ,  $V^- = -5$ ,  $R_F = R_L = 2\text{k}\Omega$ . Unless otherwise specified. (Continued)

**Closed Loop Output Impedance vs. Frequency  $A_V = +1$**

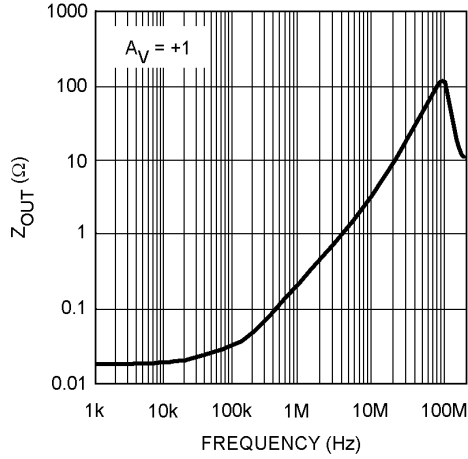

20018502

**PSRR vs. Frequency**

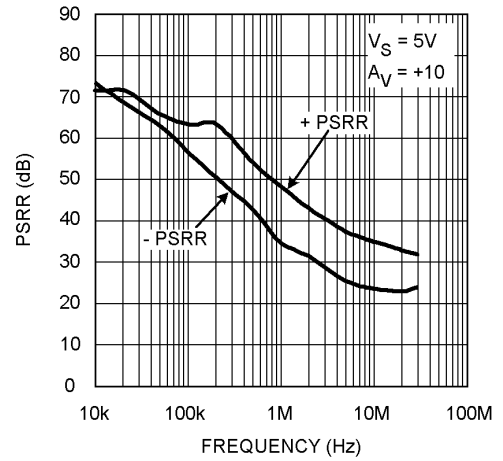

20018503

**CMRR vs. Frequency**

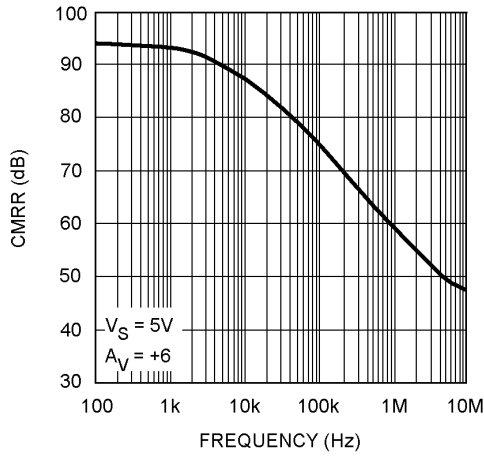

20018507

**Crosstalk Rejection vs. Frequency (Output to Output)**

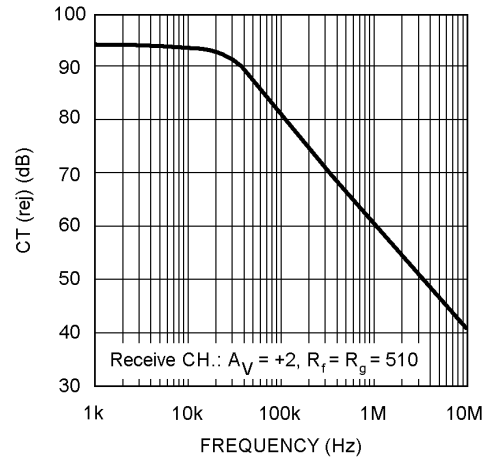

20018511

**$V_{OS}$  vs.  $V_{OUT}$  (Typical Unit)**

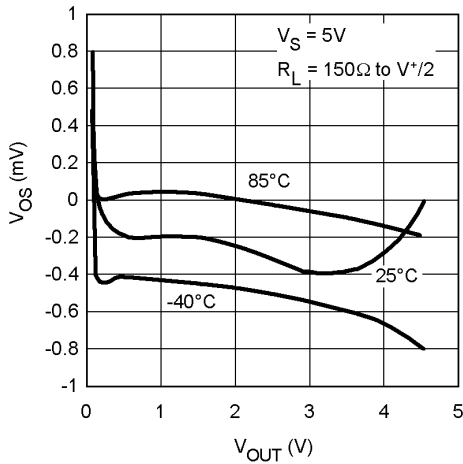

20018530

**$V_{OS}$  vs.  $V_{CM}$  (Typical Unit)**

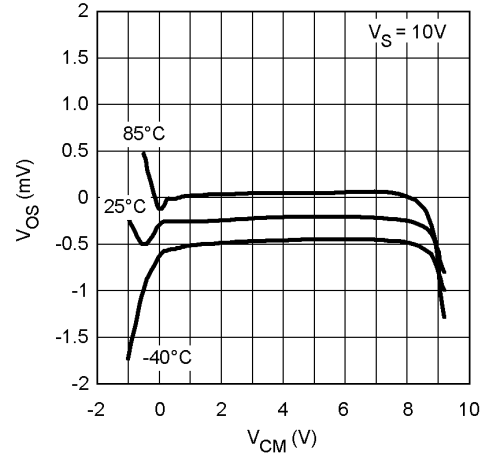

20018527

**Typical Performance Characteristics** At  $T_J = 25^\circ\text{C}$ ,  $V^+ = +5\text{V}$ ,  $V^- = -5\text{V}$ ,  $R_F = R_L = 2\text{k}\Omega$ . Unless otherwise specified. (Continued)

**$V_{OS}$  vs.  $V_S$  (for 3 Representative Units)**

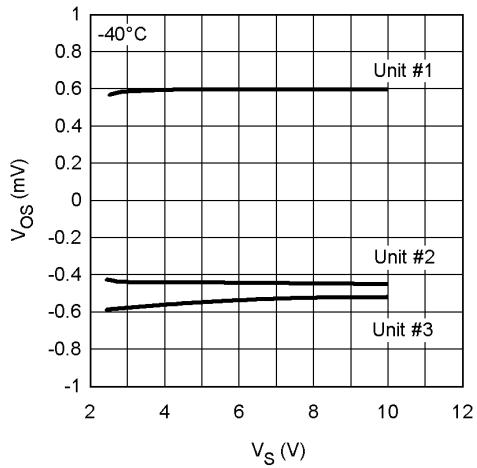

**$V_{OS}$  vs.  $V_S$  (for 3 Representative Units)**

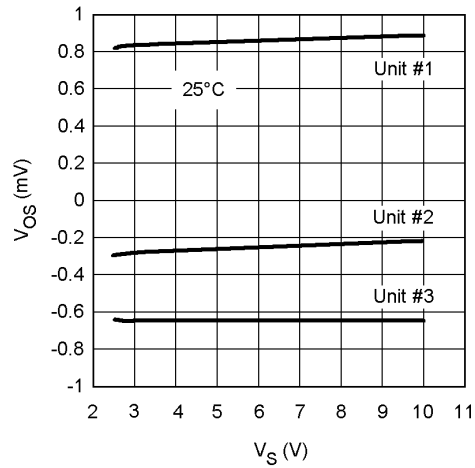

**$V_{OS}$  vs.  $V_S$  (for 3 Representative Units)**

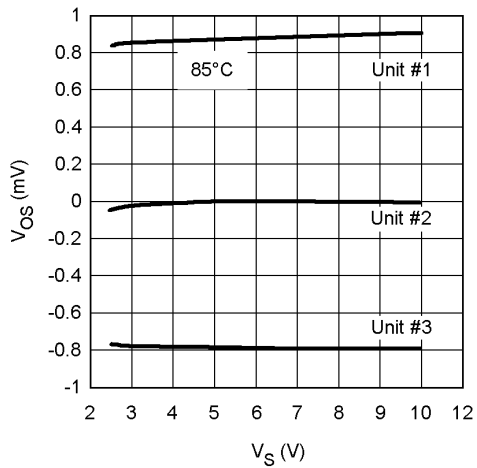

**$I_B$  vs.  $V_S$**

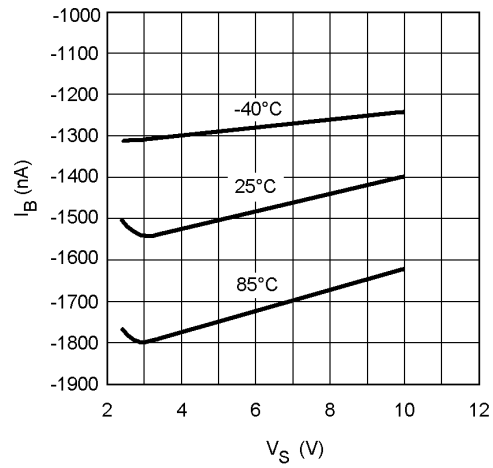

**$I_{OS}$  vs.  $V_S$**

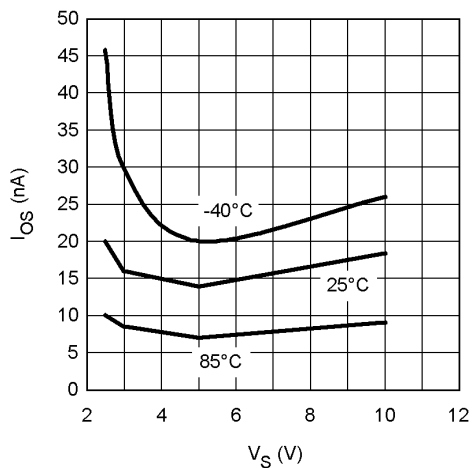

**$I_S$  vs.  $V_{CM}$**

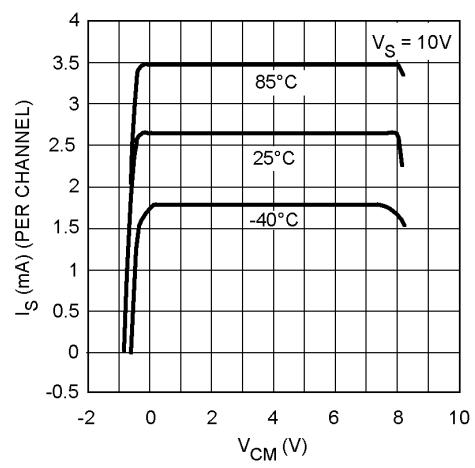

**Typical Performance Characteristics** At  $T_J = 25^\circ\text{C}$ ,  $V^+ = +5$ ,  $V^- = -5$ ,  $R_F = R_L = 2\text{k}\Omega$ . Unless otherwise specified. (Continued)

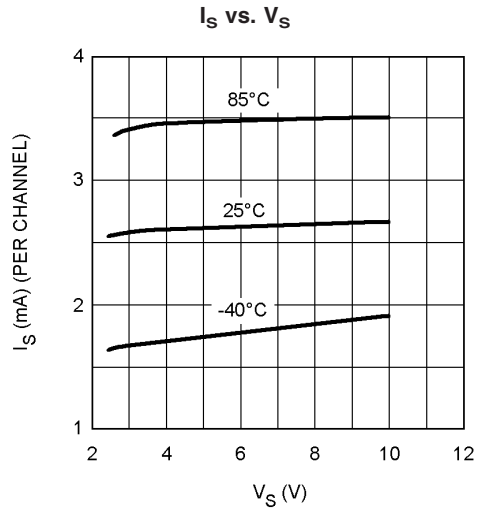

20018521

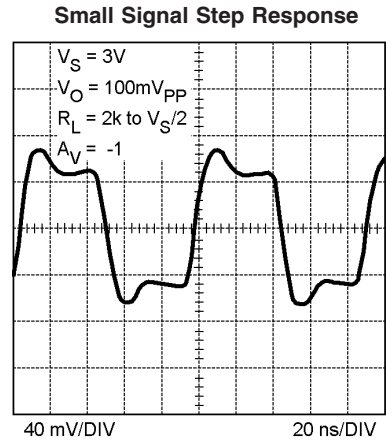

20018553

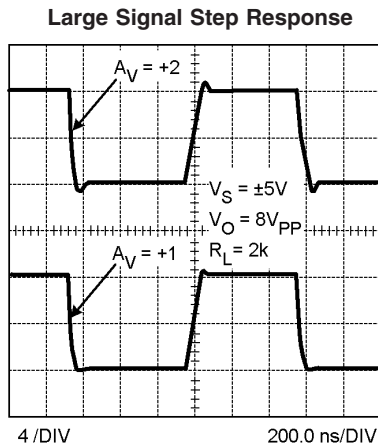

20018541

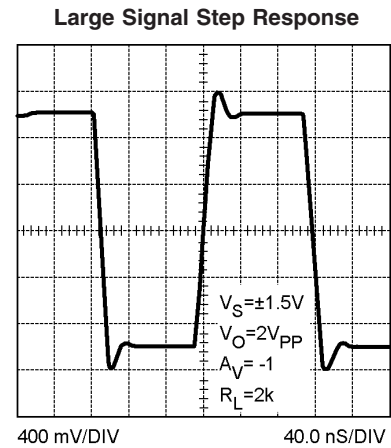

20018539

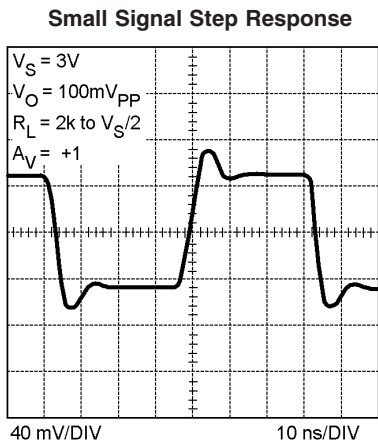

20018556

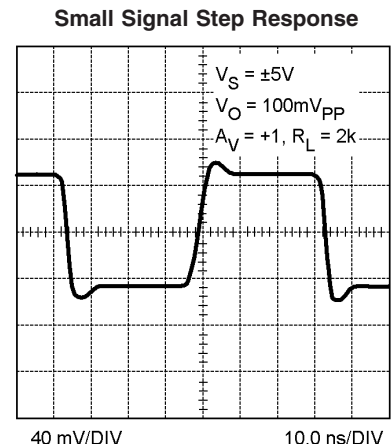

20018536

**Typical Performance Characteristics** At  $T_J = 25^\circ\text{C}$ ,  $V^+ = +5$ ,  $V^- = -5$ ,  $R_F = R_L = 2\text{k}\Omega$ . Unless otherwise specified. (Continued)

**Small Signal Step Response**

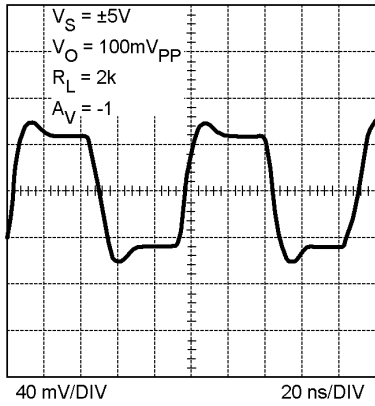

20018552

**Small Signal Step Response**

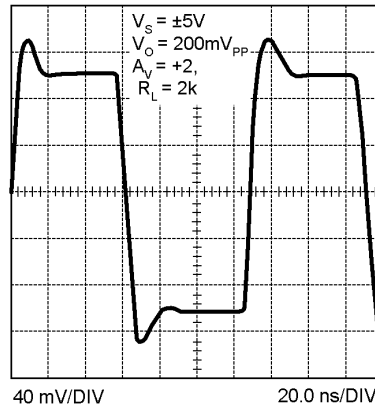

20018538

**Large Signal Step Response**

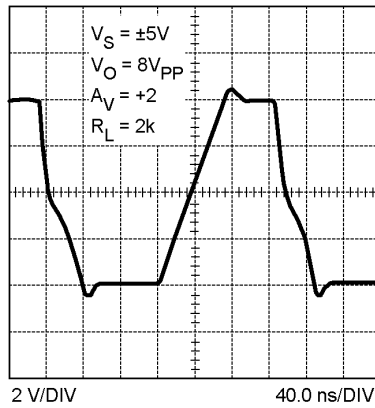

20018537

**Large Signal Step Response**

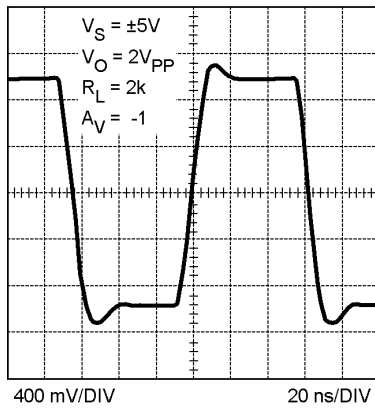

20018554

**Large Signal Step Response**

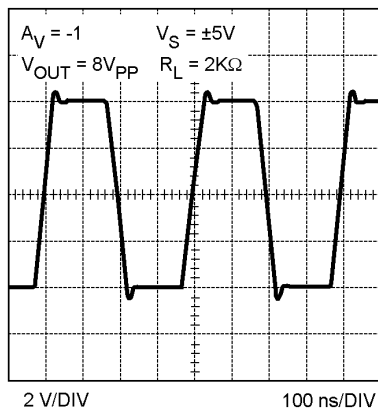

20018560

## Application Notes

### CIRCUIT DESCRIPTION

The LMH664X family is based on National Semiconductor's proprietary VIP10 dielectrically isolated bipolar process.

This device family architecture features the following:

- Complimentary bipolar devices with exceptionally high  $f_t$  (~8GHz) even under low supply voltage (2.7V) and low bias current.
- A class A-B "turn-around" stage with improved noise, offset, and reduced power dissipation compared to similar speed devices (patent pending).
- Common Emitter push-push output stage capable of 75mA output current (at 0.5V from the supply rails) while consuming only 2.7mA of total supply current per channel. This architecture allows output to reach within millivolts of either supply rail.
- Consistent performance from any supply voltage (3V-10V) with little variation with supply voltage for the most important specifications (e.g. BW, SR,  $I_{OUT}$ , etc.)
- Significant power saving (~40%) compared to competitive devices on the market with similar performance.

### Application Hints

This Op Amp family is a drop-in replacement for the AD805X family of high speed Op Amps in most applications. In addition, the LMH664X will typically save about 40% on power dissipation, due to lower supply current, when compared to competition. All AD805X family's guaranteed parameters are included in the list of LMH664X guaranteed specifications in order to ensure equal or better level of performance. However, as in most high performance parts, due to subtleties of applications, it is strongly recommended that the performance of the part to be evaluated is tested under actual operating conditions to ensure full compliance to all specifications.

With 3V supplies and a common mode input voltage range that extends 0.5V below  $V^-$ , the LMH664X find applications in low voltage/low power applications. Even with 3V supplies, the -3dB BW (@  $A_V = +1$ ) is typically 115MHz with a tested limit of 80MHz. Production testing guarantees that process variations will not compromise speed. High frequency response is exceptionally stable confining the typical -3dB BW over the industrial temperature range to  $\pm 2.5\%$ .

As can be seen from the typical performance plots, the LMH664X output current capability (~75mA) is enhanced compared to AD805X. This enhancement, increases the output load range, adding to the LMH664X's versatility.

Because of the LMH664X's high output current capability attention should be given to device junction temperature in order not to exceed the Absolute Maximum Rating.

This device family was designed to avoid output phase reversal. With input overdrive, the output is kept near supply rail (or as closed to it as mandated by the closed loop gain setting and the input voltage). See *Figure 1*:

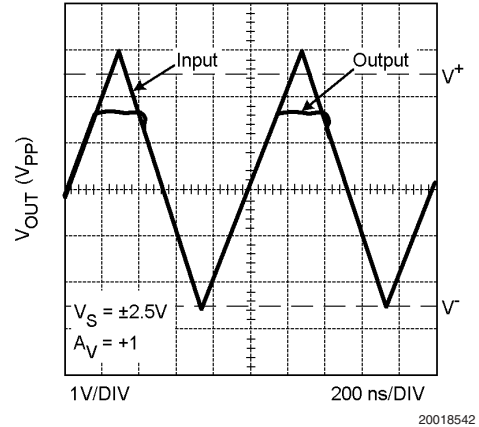

**FIGURE 1. Input and Output Shown with CMVR Exceeded**

However, if the input voltage range of  $-0.5V$  to  $1V$  from  $V^+$  is exceeded by more than a diode drop, the internal ESD protection diodes will start to conduct. The current in the diodes should be kept at or below 10mA.

Output overdrive recovery time is less than 100ns as can be seen from *Figure 2* plot:

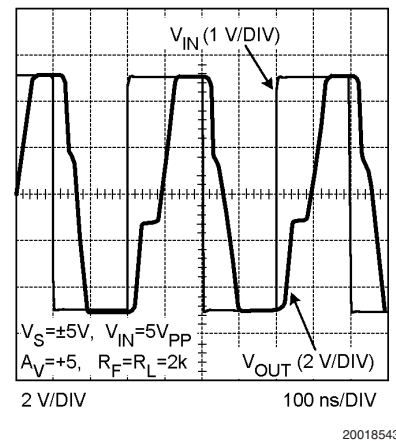

**FIGURE 2. Overload Recovery Waveform**



## Application Notes (Continued)

### SINGLE SUPPLY, LOW POWER PHOTODIODE AMPLIFIER

The circuit shown in *Figure 3* is used to amplify the current from a photo-diode into a voltage output. In this circuit, the emphasis is on achieving high bandwidth and the transimpedance gain setting is kept relatively low. Because of its high slew rate limit and high speed, the LMH664X family lends itself well to such an application.

This circuit achieves approximately 1V/mA of transimpedance gain and capable of handling up to 1mA<sub>pp</sub> from the photodiode. Q1, in a common base configuration, isolates the high capacitance of the photodiode ( $C_d$ ) from the Op Amp input in order to maximize speed. Input is AC coupled through C1 to ease biasing and allow single supply operation. With 5V single supply, the device input/output is shifted to near half supply using a voltage divider from  $V_{CC}$ . Note that Q1 collector does not have any voltage swing and the Miller effect is minimized. D1, tied to Q1 base, is for temperature compensation of Q1's bias point. Q1 collector current was set to be large enough to handle the peak-to-peak photodiode excitation and not too large to shift the U1 output too far from mid-supply.

No matter how low an  $R_f$  is selected, there is a need for  $C_f$  in order to stabilize the circuit. The reason for this is that the Op

Amp input capacitance and Q1 equivalent collector capacitance together ( $C_{IN}$ ) will cause additional phase shift to the signal fed back to the inverting node.  $C_f$  will function as a zero in the feedback path counter-acting the effect of the  $C_{IN}$  and acting to stabilize the circuit. By proper selection of  $C_f$  such that the Op Amp open loop gain is equal to the inverse of the feedback factor at that frequency, the response is optimized with a theoretical 45° phase margin.

$$C_f = \sim \text{SQRT} \left[ \frac{C_{IN}}{2\pi \cdot \text{GBWP} \cdot R_f} \right] \quad (1)$$

where GBWP is the Gain Bandwidth Product of the Op Amp. Optimized as such, the I-V converter will have a theoretical pole,  $f_p$ , at:

$$f_p = \text{SQRT} \left[ \frac{\text{GBWP}}{2\pi R_f \cdot C_{IN}} \right] \quad (2)$$

With Op Amp input capacitance of 3pF and an estimate for Q1 output capacitance of about 3pF as well,  $C_{IN} = 6\text{pF}$ . From the typical performance plots, LMH6642/6643 family GBWP is approximately 57MHz. Therefore, with  $R_f = 1\text{k}$ , from Equation 1 and 2 above.

$C_f = \sim 4.1\text{pF}$ , and  $f_p = 39\text{MHz}$

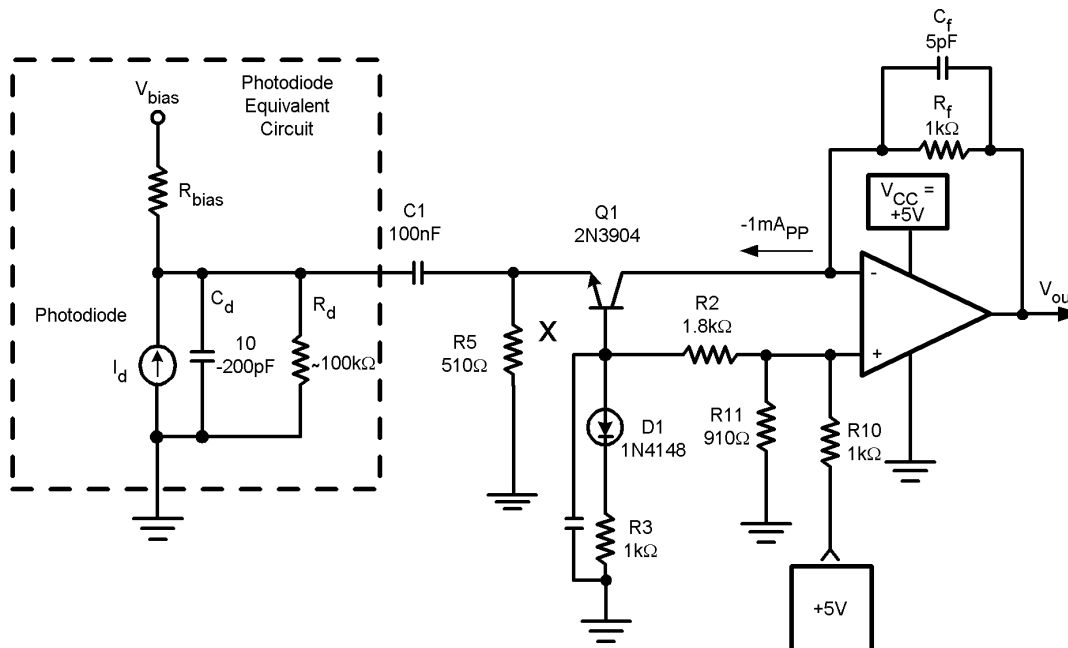

20018564

FIGURE 3. Single Supply Photodiode I-V Converter

## Application Notes (Continued)

For this example, optimum  $C_f$  was empirically determined to be around 5pF. This time domain response is shown in *Figure 4* below showing about 9ns rise/fall times, corresponding to about 39MHz for  $f_p$ . The overall supply current from the +5V supply is around 5mA with no load.

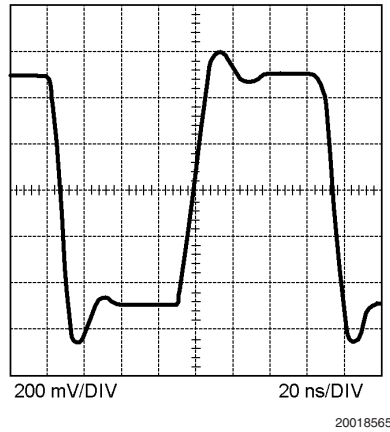

**FIGURE 4. Converter Step Response (1V<sub>PP</sub>, 20 ns/DIV)**

## PRINTED CIRCUIT BOARD LAYOUT AND COMPONENT VALUES SECTION

Generally, a good high frequency layout will keep power supply and ground traces away from the inverting input and output pins. Parasitic capacitances on these nodes to ground will cause frequency response peaking and possible circuit oscillations (see Application Note OA-15 for more information). National Semiconductor suggests the following evaluation boards as a guide for high frequency layout and as an aid in device testing and characterization:

Device	Package	Evaluation Board PN
LMH6642MF	SOT23-5	CLC730216
LMH6642MA	8-Pin SOIC	CLC730227
LMH6643MA	8-Pin SOIC	CLC730036
LMH6643MM	8-Pin MSOP	CLC730123
LMH6644MA	14-Pin SOIC	CLC730231
LMH6644MT	14-Pin TSSOP	CLC730131

These free evaluation boards are shipped when a device sample request is placed with National Semiconductor.

Another important parameter in working with high speed/high performance amplifiers, is the component values selection. Choosing external resistors that are large in value will effect the closed loop behavior of the stage because of the interaction of these resistors with parasitic capacitances. These capacitors could be inherent to the device or a by-product of the board layout and component placement. Either way, keeping the resistor values lower, will diminish this interaction to a large extent. On the other hand, choosing very low value resistors could load down nodes and will contribute to higher overall power dissipation.

## Ordering Information

Package	Part Number	Package Marking	Transport Media	NSC Drawing
5-Pin SOT23	LMH6642MF	A64A	1k Units Tape and Reel	MF05A
	LMH6642MFX		3k Units Tape and Reel	
8-Pin SOIC	LMH6642MA	LMH6642MA	95 Units/Rail	M08A
	LMH6642MAX		2.5k Units Tape and Reel	
	LMH6643MA	LMH6643MA	95 Units/Rail	
	LMH6643MAX		2.5k Units Tape and Reel	
8-Pin MSOP	LMH6643MM	A65A	1k Units Tape and Reel	MUA08A
	LMH6643MMX		3.5k Units Tape and Reel	
14-Pin SOIC	LMH6644MA	LMH6644MA	55 units/Rail	M14A
	LMH6644MAX		2.5k Units Tape and Reel	
14-Pin TSSO	LMH6644MT	LMH6644MT	94 Units/Rail	MTC14
	LMH6644MTX		2.5k Units Tape and Reel	

**Physical Dimensions** inches (millimeters) unless otherwise noted

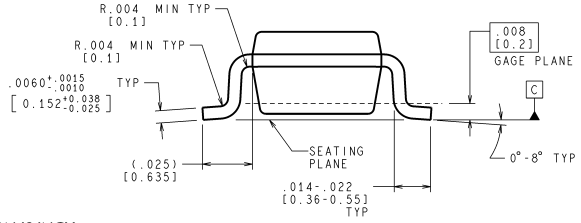
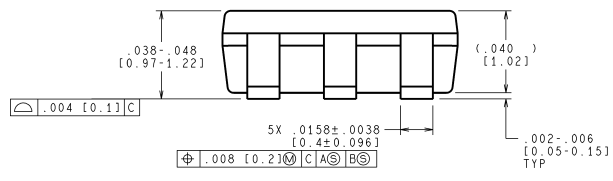
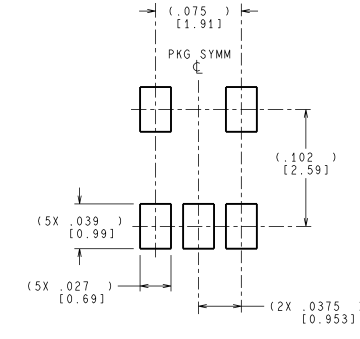
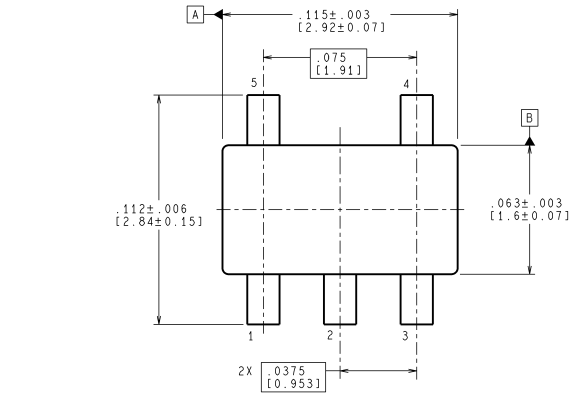

CONTROLLING DIMENSION IS INCH  
 VALUES IN [ ] ARE MILLIMETERS  
 DIMENSIONS IN ( ) FOR REFERENCE ONLY

MF05A (Rev C)

**5-Pin SOT23**  
**NS Package Number MF05A**

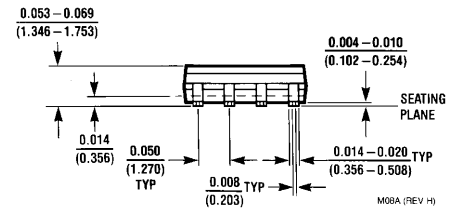
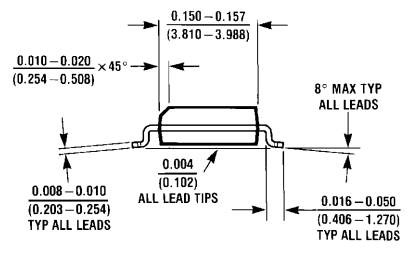
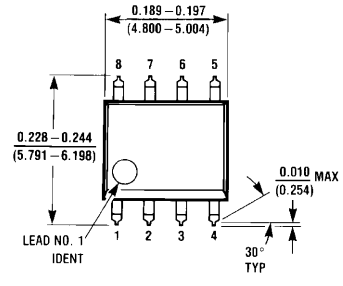

**8-Pin SOIC**  
**NS Package Number M08A**

M08A (REV H)

**Physical Dimensions** inches (millimeters) unless otherwise noted (Continued)

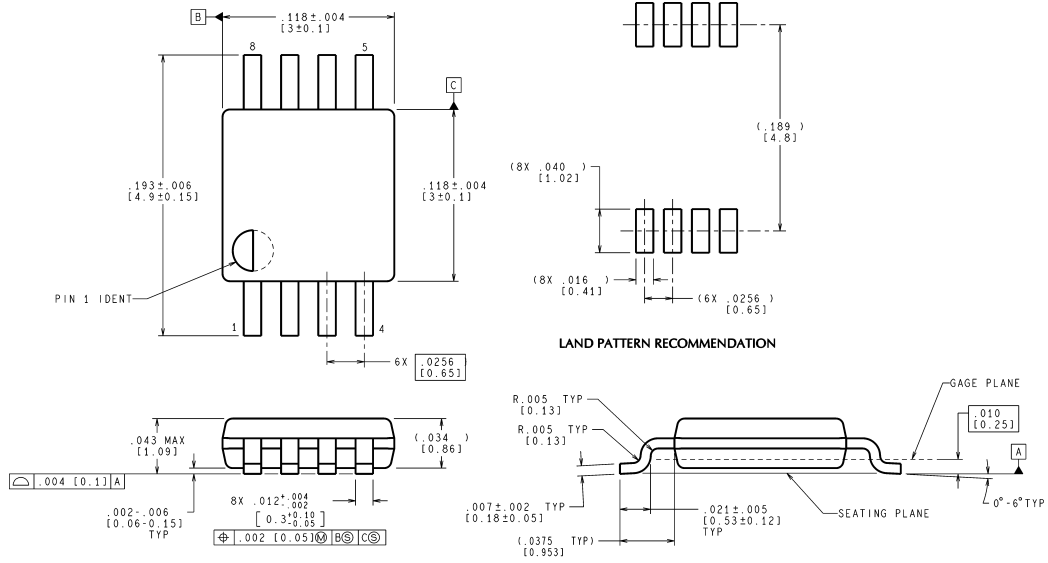

CONTROLLING DIMENSION IS INCH  
VALUES IN [ ] ARE MILLIMETERS

MUA08A (Rev E)

**8-Pin MSOP**  
**NS Package Number MUA08A**

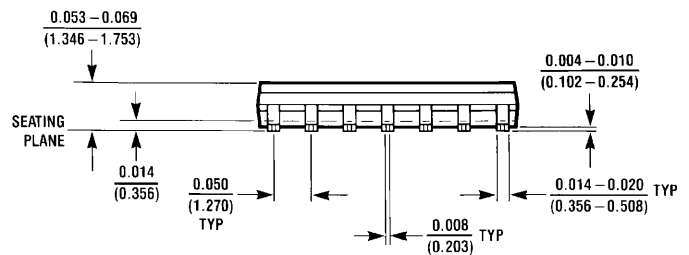
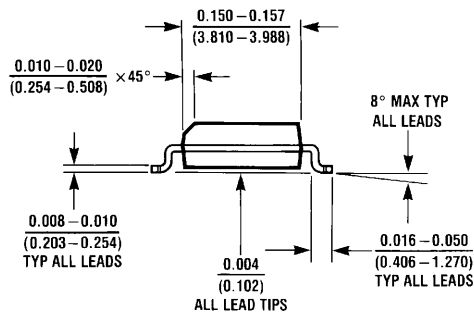
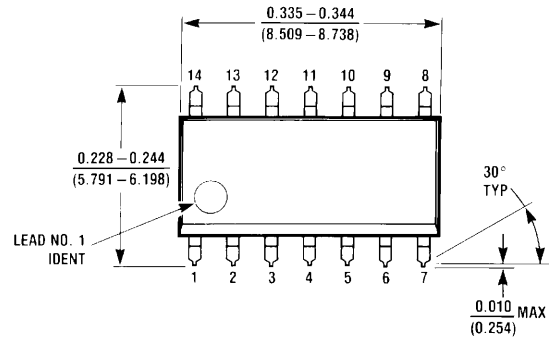

M14A (REV H)

**14-Pin SOIC**  
**NS Package Number M14A**

**Physical Dimensions** inches (millimeters) unless otherwise noted (Continued)

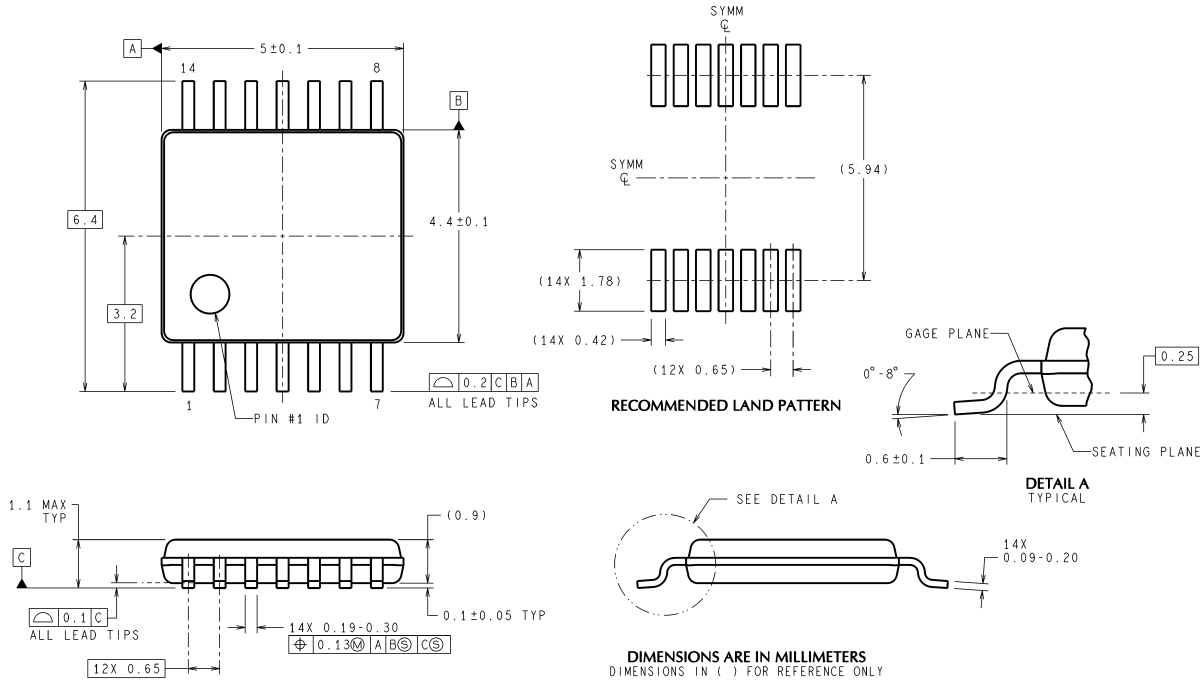

MTC14 (Rev D)

**14-Pin TSSOP  
NS Package Number MTC14**

National does not assume any responsibility for use of any circuitry described, no circuit patent licenses are implied and National reserves the right at any time without notice to change said circuitry and specifications.  
For the most current product information visit us at [www.national.com](http://www.national.com).

**LIFE SUPPORT POLICY**

NATIONAL'S PRODUCTS ARE NOT AUTHORIZED FOR USE AS CRITICAL COMPONENTS IN LIFE SUPPORT DEVICES OR SYSTEMS WITHOUT THE EXPRESS WRITTEN APPROVAL OF THE PRESIDENT AND GENERAL COUNSEL OF NATIONAL SEMICONDUCTOR CORPORATION. As used herein:

1. Life support devices or systems are devices or systems which, (a) are intended for surgical implant into the body, or (b) support or sustain life, and whose failure to perform when properly used in accordance with instructions for use provided in the labeling, can be reasonably expected to result in a significant injury to the user.
2. A critical component is any component of a life support device or system whose failure to perform can be reasonably expected to cause the failure of the life support device or system, or to affect its safety or effectiveness.

**BANNED SUBSTANCE COMPLIANCE**

National Semiconductor follows the provisions of the Product Stewardship Guide for Customers (CSP-9-111C2) and Banned Substances and Materials of Interest Specification (CSP-9-111S2) for regulatory environmental compliance. Details may be found at: [www.national.com/quality/green](http://www.national.com/quality/green).

Lead free products are RoHS compliant.



**National Semiconductor**  
Americas Customer  
Support Center  
Email: [new.feedback@nsc.com](mailto:new.feedback@nsc.com)  
Tel: 1-800-272-9959

**National Semiconductor**  
Europe Customer Support Center  
Fax: +49 (0) 180-530 85 86  
Email: [europe.support@nsc.com](mailto:europe.support@nsc.com)  
Deutsch Tel: +49 (0) 69 9508 6208  
English Tel: +44 (0) 870 24 0 2171  
Français Tel: +33 (0) 1 41 91 8790

**National Semiconductor**  
Asia Pacific Customer  
Support Center  
Email: [ap.support@nsc.com](mailto:ap.support@nsc.com)

**National Semiconductor**  
Japan Customer Support Center  
Fax: 81-3-5639-7507  
Email: [jpn.feedback@nsc.com](mailto:jpn.feedback@nsc.com)  
Tel: 81-3-5639-7560

[www.national.com](http://www.national.com)