

FEATURES

- *Guaranteed* 1.0mV Max. Input Offset Voltage
- *Guaranteed* 100,000 Min. Gain
- *Guaranteed* 50V/ μ s Slew Rate
- *Guaranteed* 20nA Max. Input Offset Current
- 15MHz Bandwidth
- Unity Gain Stable

APPLICATIONS

- Wideband Amplifiers
- High Frequency Absolute Value Circuits
- D/A Converter Amplifiers
- Fast Integrators

DESCRIPTION

The LT118A is an improved version of the industry standard LM118. The LT118A features lower input offset voltage, lower input offset currents, higher gain and higher common mode and power supply rejection. Because of these enhancements, the LT118A will improve the accuracy of most applications. Unlike many wideband amplifiers, the LT118A is unity gain stable and has a slew rate of 50V/ μ s. When used in inverting amplifier applications, feedforward compensation can be used to achieve slew rates in excess of 150V/ μ s. Linear Technology Corporation's advanced processing techniques make the LT118A an ideal choice for high speed applications.

2

Voltage Follower

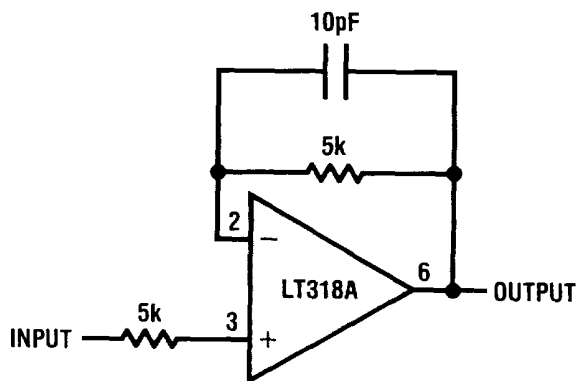

Voltage Follower Pulse Response

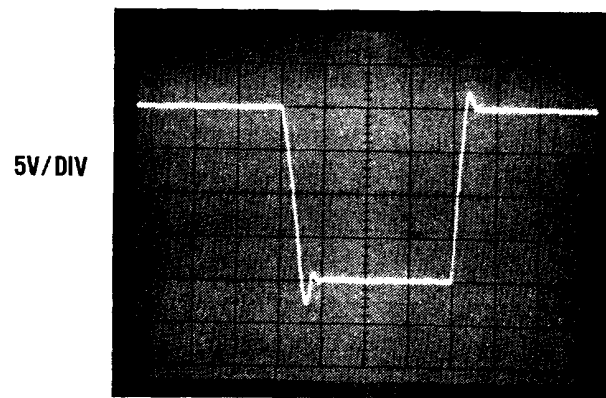

TIME \rightarrow 0.5 μ s/DIV.

ABSOLUTE MAXIMUM RATINGS

Supply Voltage	± 20V
Differential Input Current (Note 1)	± 10mA
Input Voltage (Note 2)	± 20V
Output Short Circuit Duration	Indefinite
Operating Temperature Range	
LT118A/LM118	− 55°C to 125°C
LT318A/LM318	0°C to 70°C
Storage Temperature Range	
All Devices	− 65°C to 150°C
Lead Temperature (Soldering, 10 sec.)	300°C

PACKAGE/ORDER INFORMATION

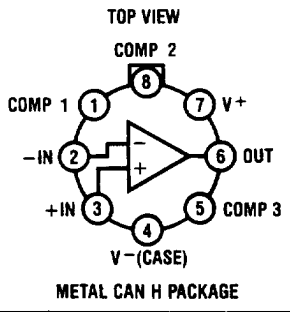
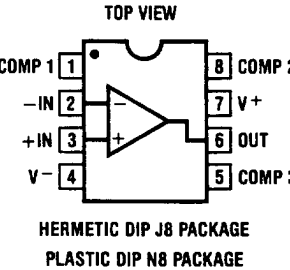
TOP VIEW	ORDER PART NUMBER
 <p>TOP VIEW COMP 2 COMP 1 (1) (8) (7) V+ -IN (2) (6) OUT +IN (3) (5) COMP 3 V-(CASE) (4)</p> <p>METAL CAN H PACKAGE</p>	<p>LT118AH LM118H LT318AH LM318H</p>
 <p>TOP VIEW COMP 1 (1) (8) COMP 2 -IN (2) (7) V+ +IN (3) (6) OUT V- (4) (5) COMP 3</p> <p>HERMETIC DIP J8 PACKAGE PLASTIC DIP N8 PACKAGE</p>	<p>LT118AJ8 LM118J8 LT318AJ8 LM318J8 LT318AN8 LM318N8</p>

ELECTRICAL CHARACTERISTICS (Note 3)

SYMBOL	PARAMETER	CONDITIONS	LT118A			LM118			UNITS
			MIN	TYP	MAX	MIN	TYP	MAX	
V _{OS}	Input Offset Voltage		0.5	1		2	4		mV
			1	2		6			mV
I _{OS}	Input Offset Current		6	20		6	50		nA
			10	30		100			nA
I _B	Input Bias Current		120	250		120	250		nA
				500		500			nA
R _{IN}	Input Resistance		1	3		1	3		MΩ
A _V	Large Signal Voltage Gain	V _S = ± 15V, V _{OUT} = ± 10V, R _L ≥ 2kΩ	100	500		50	200		V/mV
			100			25			V/mV
SR	Slew Rate	V _S = ± 15V, A _V = 1	50	70		50	70		V/μs
GBW	Gain Bandwidth Product	V _S = ± 15V		15			15		MHz
	Output Voltage Swing	V _S = ± 15V, R _L = 2kΩ	± 12	± 13		± 12	± 13		V
	Input Voltage Range	V _S = ± 15V	± 11.5			± 11.5			V
I _S	Supply Current	T _A = 125°C	5	8		5	8		mA
			4.5	7		4.5	7		mA
CMRR	Common Mode Rejection Ratio		86	100		80	100		dB
PSRR	Power Supply Rejection Ratio		86	100		70	80		dB

ELECTRICAL CHARACTERISTICS (Note 3)

SYMBOL	PARAMETER	CONDITIONS	LT318A			LM318			UNITS
			MIN	TYP	MAX	MIN	TYP	MAX	
V_{OS}	Input Offset Voltage			0.5	1	4	10	15	mV mV
I_{OS}	Input Offset Current			10	20	30	200	750	nA nA
I_B	Input Bias Current			150	250	150	500	750	nA nA
R_{IN}	Input Resistance		0.5	3		0.5	3		MΩ
A_V	Large Signal Voltage Gain	$V_S = \pm 15V, V_{OUT} = \pm 10V, R_L \geq 2k\Omega$	● 100	500		25	200		V/mV V/mV
SR	Slew Rate	$V_S = \pm 15V, A_V = 1$		50	70	50	70		V/ μ s
GBW	Gain Bandwidth Product	$V_S = \pm 15V$		15		15			MHz
	Output Voltage Swing	$V_S = \pm 15V, R_L = 2k\Omega$	● ± 12	± 13		± 12	± 13		V
	Input Voltage Range	$V_S = \pm 15V$	● ± 11.5			± 11.5			V
I_S	Supply Current			5	10	5	10		mA
CMRR	Common Mode Rejection Ratio		● 86	100		70	100		dB
PSRR	Power Supply Rejection Ratio		● 86	100		65	80		dB

The ● denotes those specifications which apply over the full operating temperature range.

The shaded electrical specifications indicate those parameters which have been improved or guaranteed test limits provided for the first time.

Note 1: The inputs are shunted with back-to-back zeners for overvoltage protection. Excessive current will flow if a differential voltage greater than 5V is applied to the inputs.

Note 2: For supply voltages less than $\pm 15V$, the maximum input voltage is equal to the supply voltage.

Note 3: These specifications apply for $\pm 5V \leq V_S \leq \pm 20V$. The power supplies must be bypassed with a 0.1 μ F or greater disc capacitor within 4 inches of the device.

2

TYPICAL PERFORMANCE CHARACTERISTICS

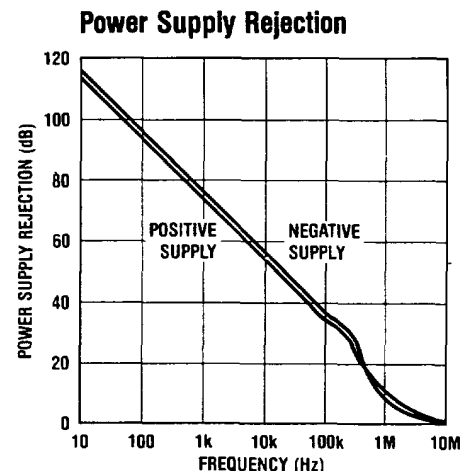
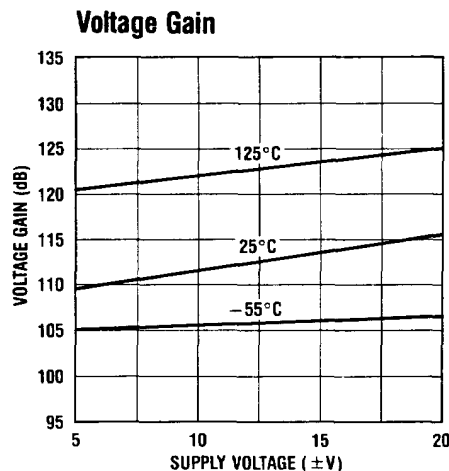
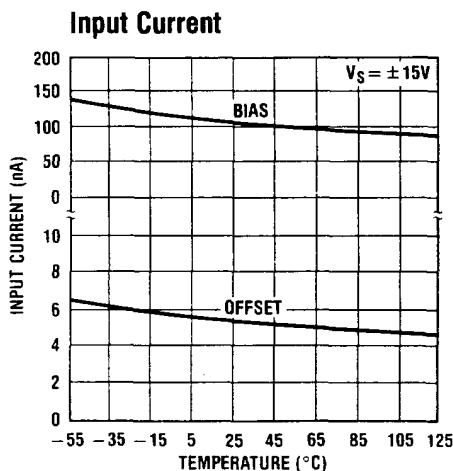

TYPICAL PERFORMANCE CHARACTERISTICS

Large Signal Frequency Response

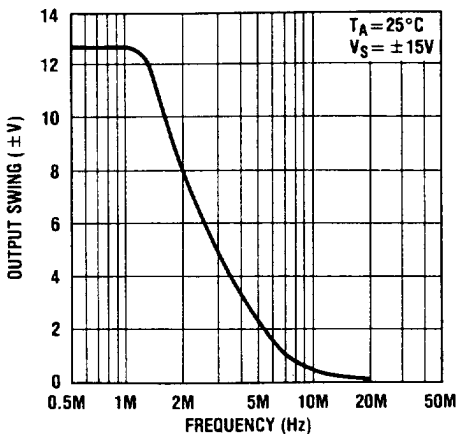

Open Loop Frequency Response

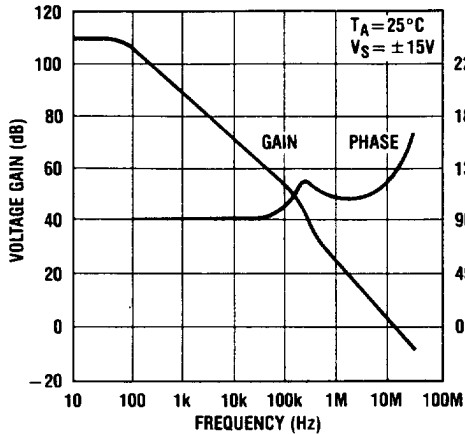

Unity Gain Bandwidth

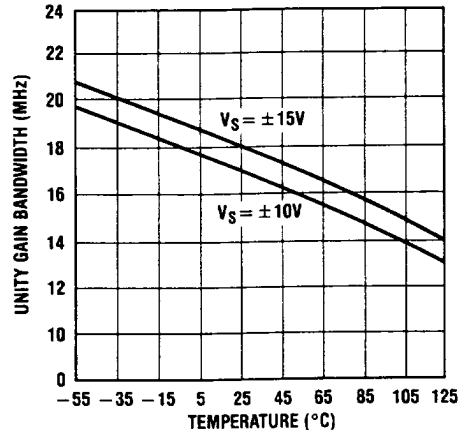

Large Signal Frequency Response

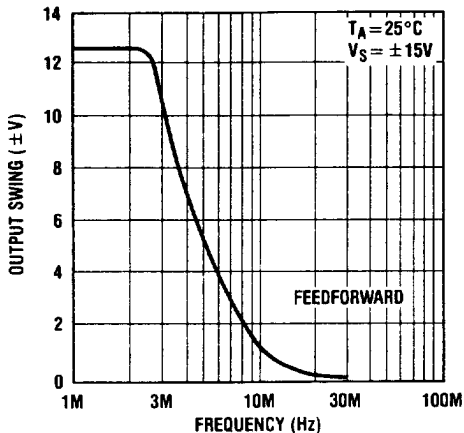

Open Loop Frequency Response

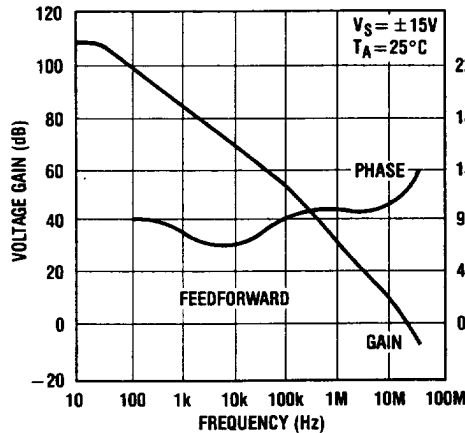

Voltage Follower Slew Rate

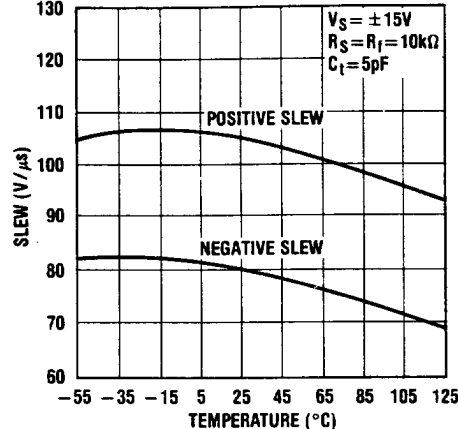

Feedforward Compensation for Slew Rates of 150V/μs

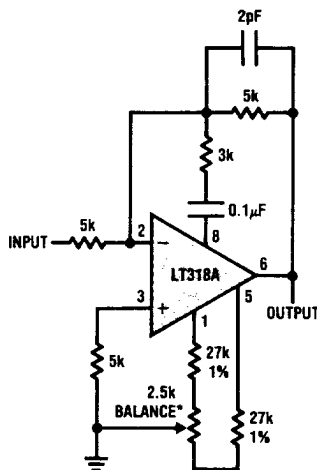

*BALANCE CIRCUIT NECESSARY FOR INCREASED SLEW RATE

Pulse Response of Feedforward Inverter

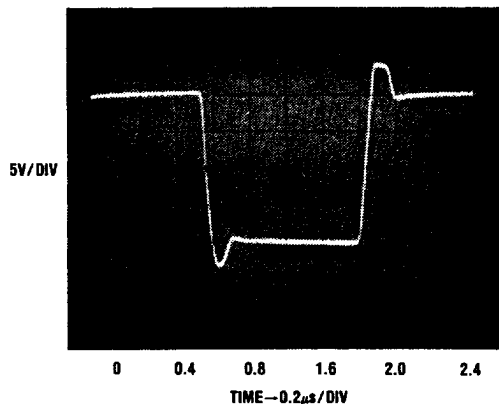

TYPICAL PERFORMANCE CHARACTERISTICS

Input Noise Voltage

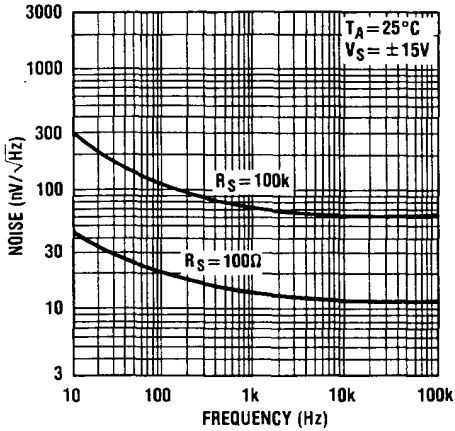

Common Mode Rejection

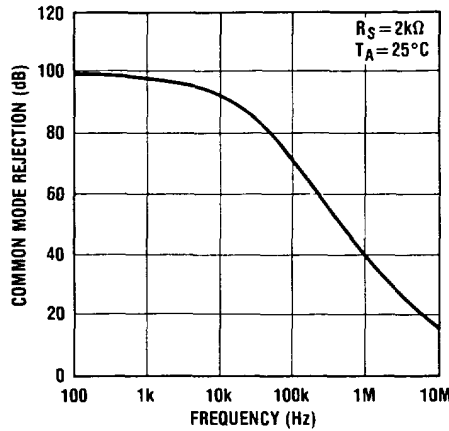

Supply Current

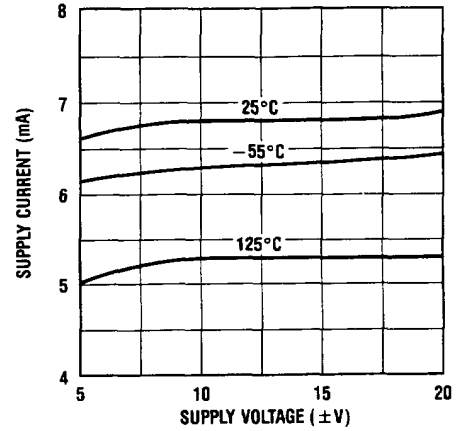

Closed Loop Output Impedance

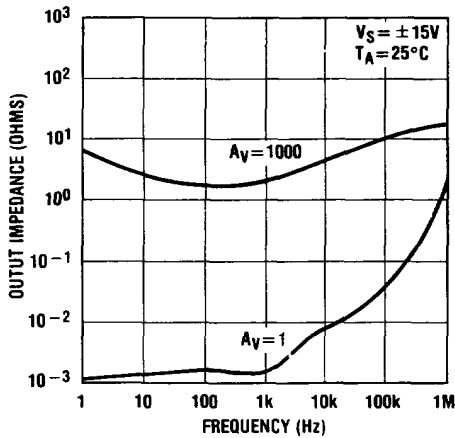

Current Limiting

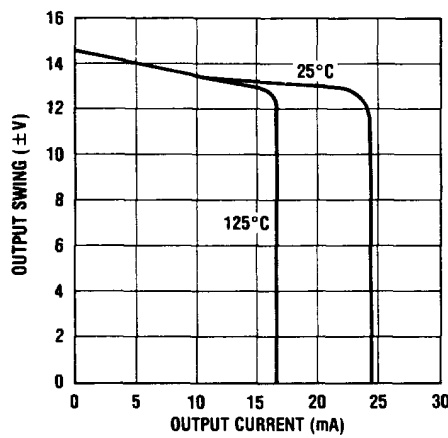

LT118A Input Current

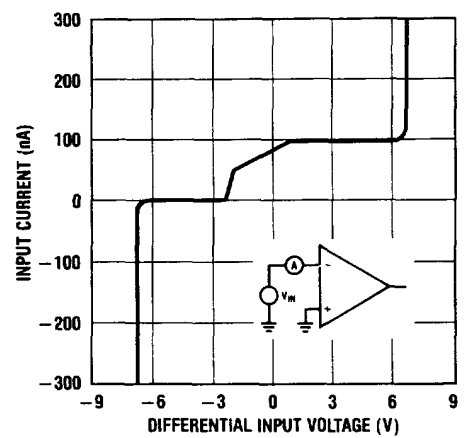

Offset Balancing

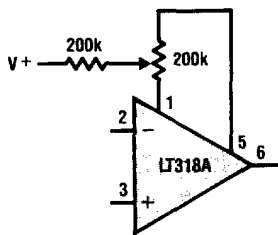

Isolating Large Capacitive Loads

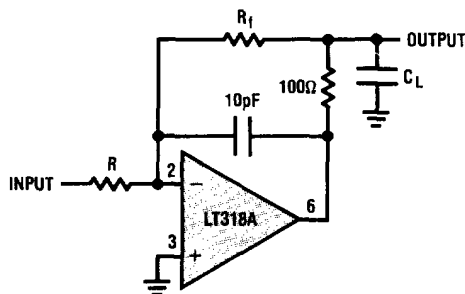

Overcompensation for Increased Stability

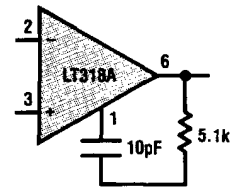

2

SETTLING TIME CIRCUITS

Settling Time Test Circuit

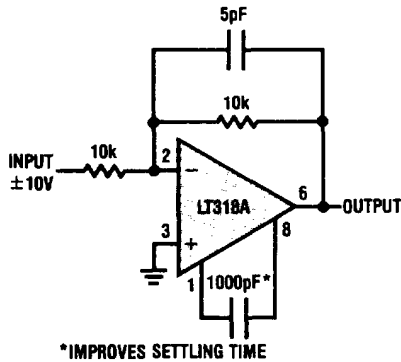

Settling Time

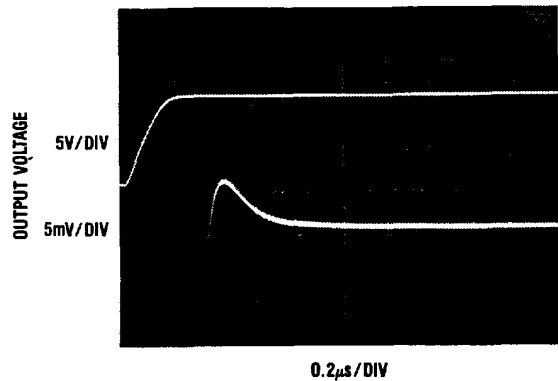

Alternate Compensation for Improved Settling Time

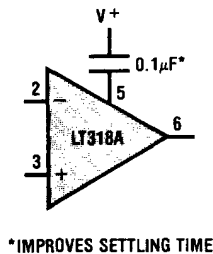

Settling Time

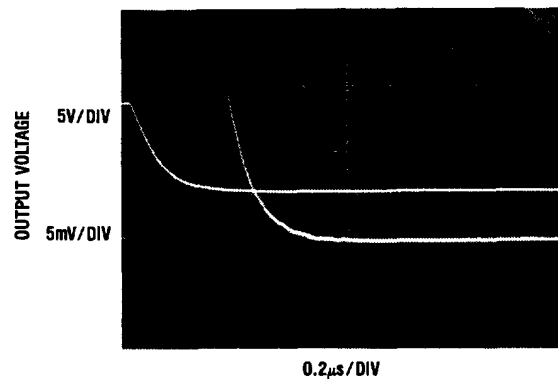

APPLICATIONS INFORMATION

Because of their wider bandwidth, the LT118A and LM118 operational amplifiers require more application care than most general purpose low frequency amplifiers. One of the most critical requirements is that power supplies should be bypassed with a 0.1 μF (or larger) disc ceramic capacitor within an inch of the device. Also, stray capacitance at either the input or output can cause oscillation. While input capacitance can be compensated by placing a capacitor across the feedback resistor, load capacitance must be minimized or isolated as shown. Even the 50pF input capacitance of a 1X scope probe can alter the response of the device.

Settling time, an important parameter in many high speed amplifier applications, is difficult to measure and optimize. Settling time is very "application dependent" and is influenced by external components, layout and the amplifier. In general, the settling time to 0.01% can be minimized by using a circuit similar to that shown. In addition to the compensation network shown, a capacitor is needed across the feedback resistor to minimize ringing.

Power supply bypassing can also affect settling time. The amplifier has low power supply rejection ratio at high frequencies, so transients and ringing on the supply leads can appear at the output. Large (22 μF) solid tantalum capacitors are preferred to minimize supply aberrations.

Precision Inverting Amplifier

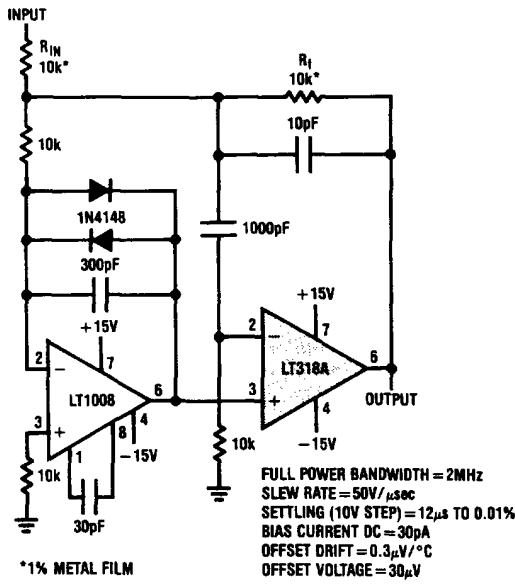

2

SCHEMATIC DIAGRAM

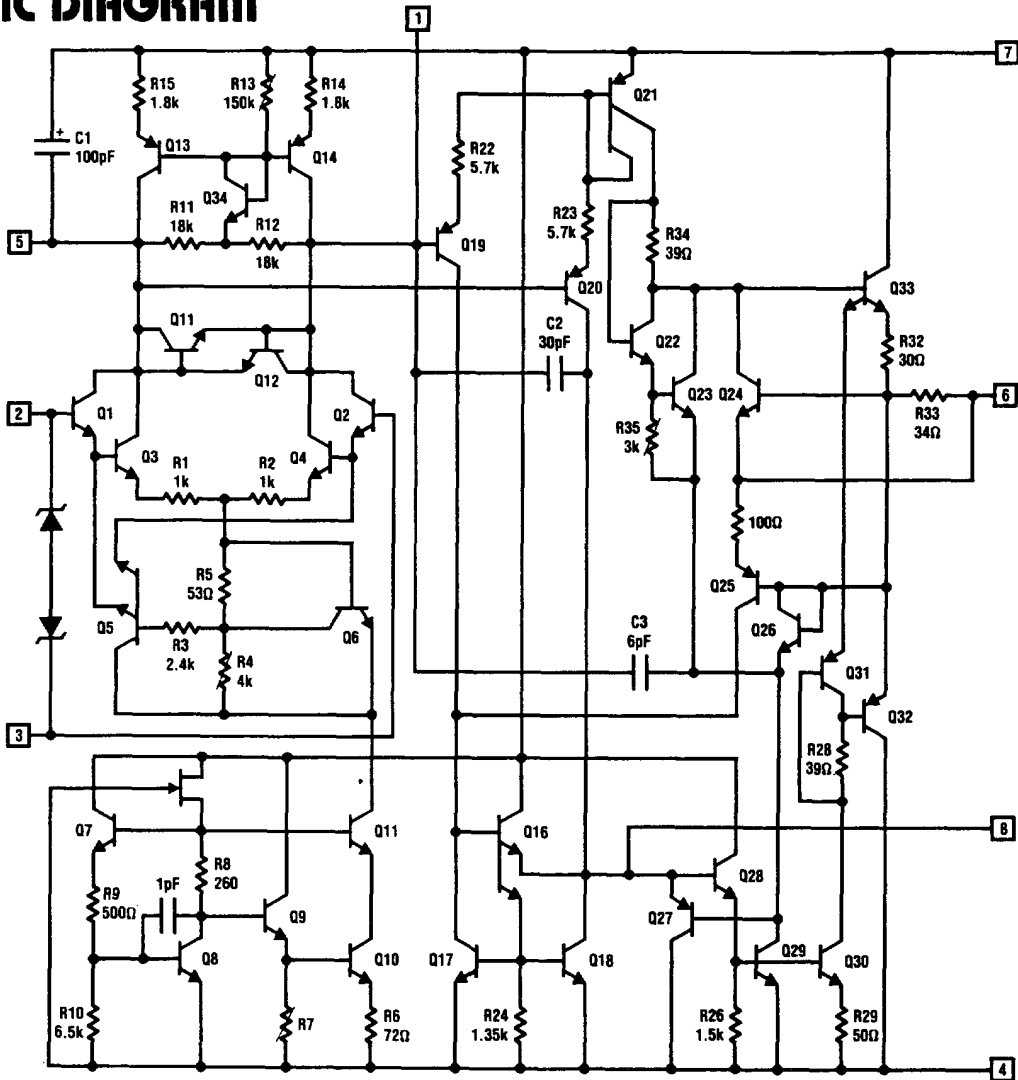

PACKAGE DESCRIPTION

**H Package
Metal Can**

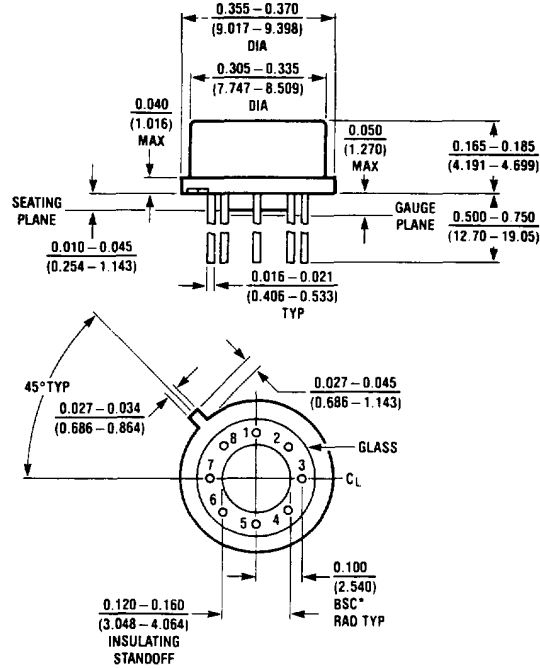

NOTE: DIMENSIONS IN INCHES

T_{jmax}	θ_{ja}	θ_{jc}
150°C	150°C/W	45°C/W

**J8 Package
8 Lead Hermetic DIP**

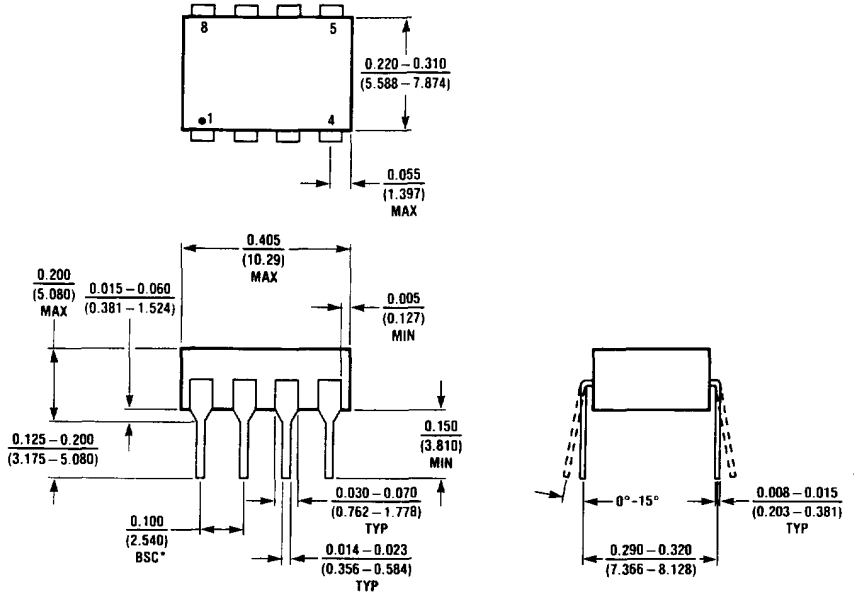

NOTE: DIMENSIONS IN INCHES UNLESS OTHERWISE NOTED
*LEADS WITHIN 0.007 OF TRUE POSITION (TP) AT GAUGE PLANE

T_{jmax}	θ_{ja}
150°C	100°C/W

**N8 Package
8 Lead Plastic**

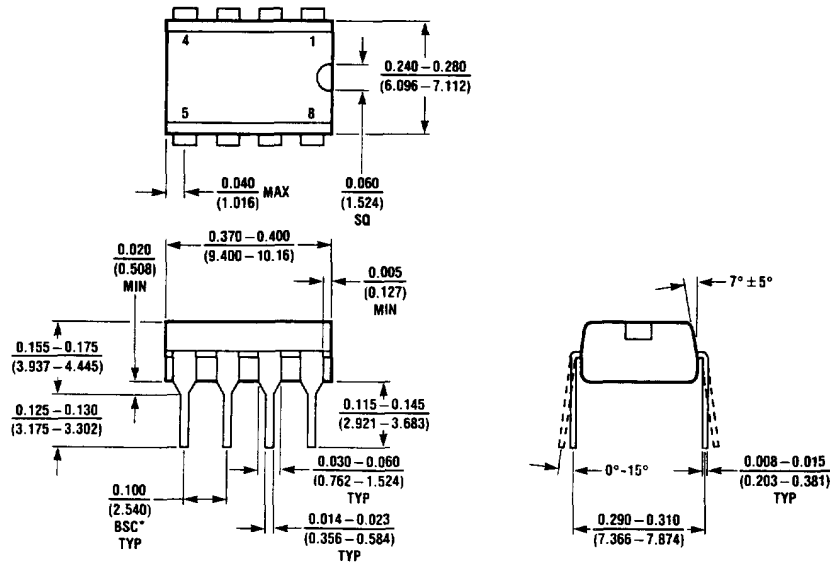

NOTE: DIMENSIONS IN INCHES UNLESS OTHERWISE NOTED
*LEADS WITHIN 0.007 OF TRUE POSITION (TP) AT GAUGE PLANE

T_{jmax}	θ_{ja}
100°C	130°C/W