

Extremely Accurate I²C RTC with Integrated Crystal and SRAM

DS3232

General Description

The DS3232 is a low-cost temperature-compensated crystal oscillator (TCXO) with a very accurate, temperature-compensated, integrated real-time clock (RTC) and 236 bytes of battery-backed SRAM. Additionally, the DS3232 incorporates a battery input and maintains accurate timekeeping when main power to the device is interrupted. The integration of the crystal resonator enhances the long-term accuracy of the device as well as reduces the piece-part count in a manufacturing line. The DS3232 is available in commercial and industrial temperature ranges, and is offered in an industry-standard 20-pin, 300-mil SO package.

The RTC maintains seconds, minutes, hours, day, date, month, and year information. The date at the end of the month is automatically adjusted for months with fewer than 31 days, including corrections for leap year. The clock operates in either the 24-hour or 12-hour format with an AM/PM indicator. Two programmable time-of-day alarms and a programmable square-wave output are provided. Address and data are transferred serially through an I²C bidirectional bus.

A precision temperature-compensated voltage reference and comparator circuit monitors the status of V_{CC} to detect power failures, to provide a reset output, and to automatically switch to the backup supply when necessary. Additionally, the RST pin is monitored as a pushbutton input for generating a reset externally.

Applications

Servers	Utility Power Meters
Telematics	GPS

Typical Operating Circuit

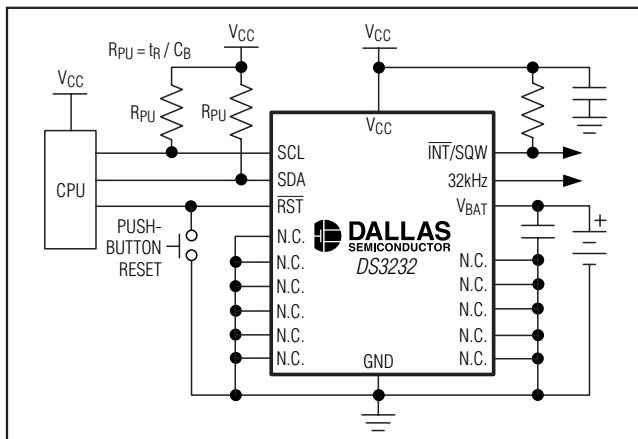

UL is a registered trademark of Underwriters Laboratories, Inc.

Features

- ◆ Accuracy ±2ppm from 0°C to +40°C
- ◆ Accuracy ±3.5ppm from -40°C to +85°C
- ◆ Battery Backup Input for Continuous Timekeeping
- ◆ Operating Temperature Ranges
Commercial: 0°C to +70°C
Industrial: -40°C to +85°C
- ◆ 236 Bytes of Battery-Backed SRAM
- ◆ Low-Power Consumption
- ◆ Real-Time Clock Counts Seconds, Minutes, Hours, Day, Date, Month, and Year with Leap Year Compensation Valid Up to 2099
- ◆ Two Time-of-Day Alarms
- ◆ Programmable Square-Wave Output
- ◆ Fast (400kHz) I²C Interface
- ◆ 3.3V Operation
- ◆ Digital Temp Sensor Output: ±3°C Accuracy
- ◆ Register for Aging Trim
- ◆ RST Input/Output
- ◆ 300-Mil, 20-Pin SO Package
- ◆ Underwriters Laboratories (UL®) Recognized

Ordering Information

PART	TEMP RANGE	PIN-PACKAGE	TOP MARK
DS3232S#	0°C to +70°C	20 SO	DS3232
DS3232SN#	-40°C to +85°C	20 SO	DS3232N

Denotes a RoHS-compliant device that may include lead that is exempt under the RoHS requirements. Lead finish is JESD97 Category e3, and is compatible with both lead-based and lead-free soldering processes. A "#" anywhere on the top mark denotes a RoHS-compliant device.

Pin Configuration

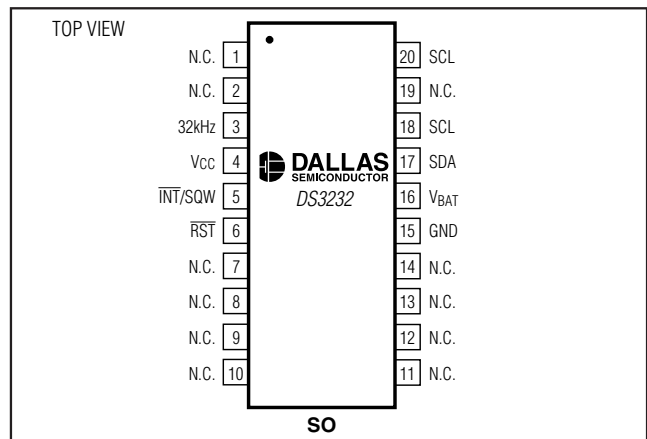

Extremely Accurate I²C RTC with Integrated Crystal and SRAM

ABSOLUTE MAXIMUM RATINGS

Voltage Range on V_{CC}, V_{BAT}, 32kHz, SCL, SDA, $\overline{\text{RST}}$,
 $\overline{\text{INT}}$ /SQW Relative to Ground-0.3V to +6.0V
 Operating Temperature Range
 (noncondensing)-40°C to +85°C
 Junction Temperature+125°C

Storage Temperature Range-40°C to +85°C
 Lead Temperature
 (soldering, 10s)+260°C/10s
 Soldering Temperature (reflow, 2 times max)See IPC/JEDEC
 J-STD-020 Specification

Stresses beyond those listed under "Absolute Maximum Ratings" may cause permanent damage to the device. These are stress ratings only, and functional operation of the device at these or any other conditions beyond those indicated in the operational sections of the specifications is not implied. Exposure to absolute maximum rating conditions for extended periods may affect device reliability.

RECOMMENDED DC OPERATING CONDITIONS

(T_A = -40°C to +85°C, unless otherwise noted.) (Notes 1, 2)

PARAMETER	SYMBOL	CONDITIONS	MIN	TYP	MAX	UNITS
Supply Voltage	V _{CC}		2.3	3.3	5.5	V
	V _{BAT}		2.3	3.0	5.5	
Logic 1 Input SDA, SCL	V _{IH}		0.7 x V _{CC}		V _{CC} + 0.3	V
Logic 0 Input SDA, SCL	V _{IL}		-0.3		+0.3 x V _{CC}	V
Pullup Voltage (SDA, SCL, $\overline{\text{INT}}$ /SQW)	V _{PU}	V _{CC} = 0V			5.5V	V

ELECTRICAL CHARACTERISTICS

(V_{CC} = 2.3V to 5.5V, V_{CC} = active supply (see Table 1), T_A = -40°C to +85°C, unless otherwise noted.) (Typical values are at V_{CC} = 3.3V, V_{BAT} = 3.0V, and T_A = +25°C, unless otherwise noted.) (Notes 1, 2)

PARAMETER	SYMBOL	CONDITIONS	MIN	TYP	MAX	UNITS
Active Supply Current	I _{CCA}	32kHz output off (Notes 3, 4)	V _{CC} = 3.3V		200	μA
			V _{CC} = 5.5V		325	
Standby Supply Current	I _{CCS}	I ² C bus inactive, 32kHz output off, SQW output off (Note 4)	V _{CC} = 3.3V		120	μA
			V _{CC} = 5.5V		160	
Temperature Conversion Current	I _{CCSCONV}	I ² C bus inactive, 32kHz output off, SQW output off	V _{CC} = 3.3V		500	μA
			V _{CC} = 5.5V		600	
Power-Fail Voltage	V _{PF}		2.45	2.575	2.70	V
ACTIVE SUPPLY (Table 1) (2.3V to 5.5V, T_A = -40°C to +85°C, unless otherwise noted) (Note 1)						
Logic 1 Output, 32kHz I _{OH} = -1mA I _{OH} = -0.75mA I _{OH} = -0.14mA	V _{OH}	Active supply > 3.3V, 3.3V > active supply > 2.7V, 2.7V > active supply > 2.3V	2.0			V

Extremely Accurate I²C RTC with Integrated Crystal and SRAM

ELECTRICAL CHARACTERISTICS (continued)

(V_{CC} = 2.3V to 5.5V, V_{CC} = active supply (see Table 1), T_A = -40°C to +85°C, unless otherwise noted.) (Typical values are at V_{CC} = 3.3V, V_{BAT} = 3.0V, and T_A = +25°C, unless otherwise noted.) (Notes 1, 2)

PARAMETER	SYMBOL	CONDITIONS		MIN	TYP	MAX	UNITS
Logic 0 Output, $\overline{\text{INT}}/\text{SQW}$, SDA	V _{OL}	I _{OL} = 3mA				0.4	V
Logic 0 Output, $\overline{\text{RST}}$, 32kHz	V _{OL}	I _{OL} = 1mA				0.4	V
Output Leakage Current 32kHz, $\overline{\text{INT}}/\text{SQW}$, SDA	I _{LO}	Output high impedance		-1	0	+1	μA
Input Leakage SCL	I _{LI}			-1		+1	μA
$\overline{\text{RST}}$ Pin I/O Leakage	I _{OL}	$\overline{\text{RST}}$ high impedance (Note 5)		-200		+10	μA
TCXO							
Output Frequency	f _{OUT}	V _{CC} = 3.3V or V _{BAT} = 3.3V			32.768		kHz
Duty Cycle (Revision A3 Devices)		2.97V ≤ V _{CC} < 3.63		31		69	%
Frequency Stability vs. Temperature	Δf/f _{OUT}	V _{CC} = 3.3V or V _{BAT} = 3.3V	0°C to +40°C	-2		+2	ppm
			-40°C to 0°C and +40°C to +85°C	-3.5		+3.5	
Frequency Stability vs. Voltage	Δf/V	V _{CC} = 3.3V or V _{BAT} = 3.3V			1		ppm/V
Trim Register Frequency Sensitivity per LSB	Δf/LSB	Specified at:	-40°C		0.7		ppm
			+25°C		0.1		
			+70°C		0.4		
			+85°C		0.8		
Temperature Accuracy	Temp	V _{CC} = 3.3V or V _{BAT} = 3.3V		-3		+3	°C
Crystal Aging	Δf/f ₀	After reflow, not production tested	First year		±1.0		ppm
			0–10 years		±5.0		

ELECTRICAL CHARACTERISTICS

(V_{CC} = 0V, V_{BAT} = 2.3V to 5.5V, T_A = -40°C to +85°C, unless otherwise noted.) (Note 1)

PARAMETER	SYMBOL	CONDITIONS		MIN	TYP	MAX	UNITS
Active Battery Current (Note 4)	I _{BATA}	$\overline{\text{EOSC}} = 0$, BBSQW = 0, SCL = 400kHz, BB32kHz = 0	V _{BAT} = 3.3V			80	μA
			V _{BAT} = 5.5V			200	
Timekeeping Battery Current (Note 4)	I _{BAT}	$\overline{\text{EOSC}} = 0$, BBSQW = 0, SCL = SDA = 0V, BB32kHz = 0, CRATE0 = CRATE1 = 0	V _{BAT} = 3.4V		1.5	2.5	μA
			V _{BAT} = 5.5V		1.5	3.0	
Temperature Conversion Current	I _{TC}	$\overline{\text{EOSC}} = 0$, BBSQW = 0, SCL = SDA = 0V				600	μA
Data-Retention Current	I _{BATTC}	$\overline{\text{EOSC}} = 1$, SCL = SDA = 0V, +25°C				100	nA

Extremely Accurate I²C RTC with Integrated Crystal and SRAM

AC ELECTRICAL CHARACTERISTICS

(Active supply (see Table 1) = 2.3V to 5.5V, T_A = -40°C to +85°C, unless otherwise noted.) (Note 1)

PARAMETER	SYMBOL	CONDITIONS	MIN	TYP	MAX	UNITS
SCL Clock Frequency	f _{SCL}	Fast mode	100		400	kHz
		Standard mode	0.04		100	
Bus Free Time Between STOP and START Conditions	t _{BUF}	Fast mode	1.3			μs
		Standard mode	4.7			
Hold Time (Repeated) START Condition (Note 6)	t _{HD:STA}	Fast mode	0.6			μs
		Standard mode	4.0			
Low Period of SCL Clock	t _{LOW}	Fast mode	1.3		25,000	μs
		Standard mode	4.7		25,000	
High Period of SCL Clock	t _{HIGH}	Fast mode	0.6			μs
		Standard mode	4.0			
Data Hold Time (Notes 7, 8)	t _{HD:DAT}	Fast mode	0		0.9	μs
		Standard mode	0		0.9	
Data Setup Time (Note 9)	t _{SU:DAT}	Fast mode	100			ns
		Standard mode	250			
Start Setup Time	t _{SU:STA}	Fast mode	0.6			μs
		Standard mode	4.7			
Rise Time of Both SDA and SCL Signals (Note 10)	t _R	Fast mode	20 + _____		300	ns
		Standard mode	0.1C _B		1000	
Fall Time of Both SDA and SCL Signals (Note 10)	t _F	Fast mode	20 + _____		300	ns
		Standard mode	0.1C _B		300	
Setup Time for STOP Condition	t _{SU:STO}	Fast mode	0.6			μs
		Standard mode	4.7			
Capacitive Load for Each Bus Line (Note 10)	C _B				400	pF
Capacitance for SDA, SCL	C _{I/O}			10		pF
Pulse Width of Spikes That Must Be Suppressed by the Input Filter	t _{SP}			30		ns
Pushbutton Debounce	PB _{DB}			250		ms
Interface Timeout	t _{IF}	(Note 11)	25		35	ms
Reset Active Time	t _{RST}			250		ms
Oscillator Stop Flag (OSF) Delay	t _{OSF}	(Note 12)		100		ms
Temperature Conversion Time	t _{CONV}			125	200	ms

POWER-SWITCH CHARACTERISTICS

(T_A = -40°C to +85°C)

PARAMETER	SYMBOL	CONDITIONS	MIN	TYP	MAX	UNITS
VCC Fall Time; V _{PF} (MAX) to V _{PF} (MIN)	t _{VCCF}		300			μs
VCC Rise Time; V _{PF} (MIN) to V _{PF} (MAX)	t _{VCCR}		0			μs
Recovery at Power-Up	t _{REC}	(Note 13)		125	300	ms

Extremely Accurate I²C RTC with Integrated Crystal and SRAM

DS3232

Pushbutton Reset Timing

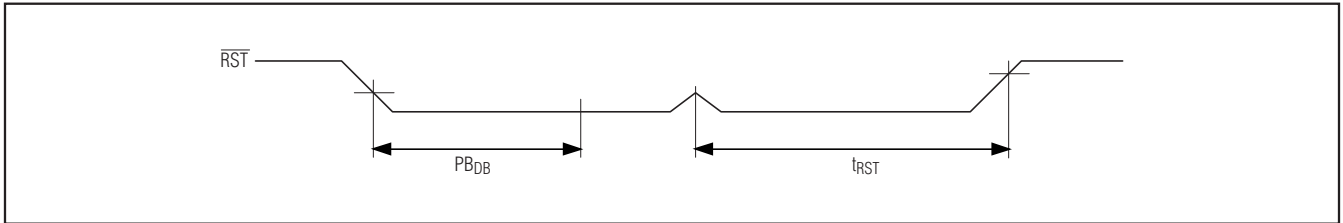

Power-Switch Timing

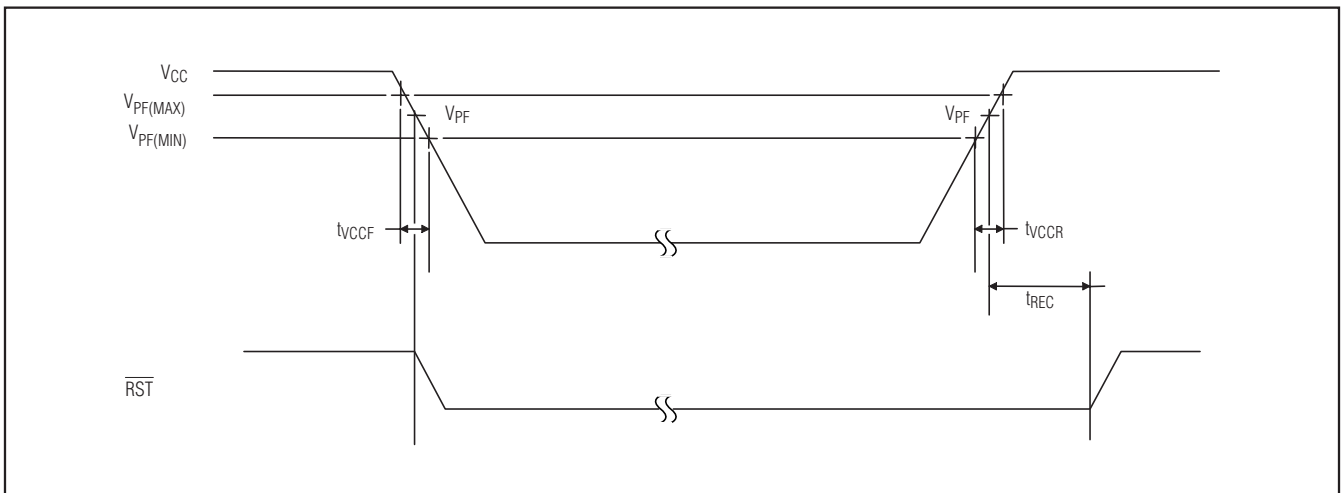

Extremely Accurate I²C RTC with Integrated Crystal and SRAM

Data Transfer on I²C Serial Bus

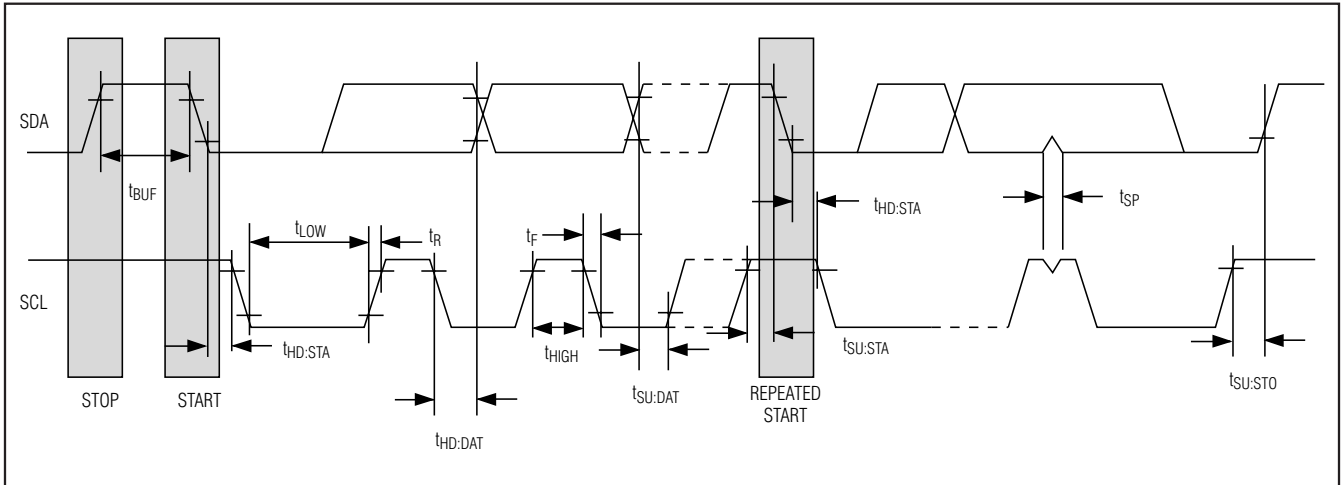

WARNING: Negative undershoots below -0.3V while the part is in battery-backed mode may cause loss of data.

Note 1: Limits at -40°C are guaranteed by design and not production tested.

Note 2: All voltages are referenced to ground.

Note 3: I_{CCA}—SCL clocking at max frequency = 400kHz.

Note 4: Current is the averaged input current, which includes the temperature conversion current.

Note 5: The $\overline{\text{RST}}$ pin has an internal 50k Ω (nominal) pullup resistor to V_{CC}.

Note 6: After this period, the first clock pulse is generated.

Note 7: A device must internally provide a hold time of at least 300ns for the SDA signal (referred to the V_{IH(MIN)} of the SCL signal) to bridge the undefined region of the falling edge of SCL.

Note 8: The maximum t_{HD:DAT} needs only to be met if the device does not stretch the low period (t_{LOW}) of the SCL signal.

Note 9: A fast-mode device can be used in a standard-mode system, but the requirement t_{SU:DAT} ≥ 250ns must then be met. This is automatically the case if the device does not stretch the low period of the SCL signal. If such a device does stretch the low period of the SCL signal, it must output the next data bit to the SDA line t_{R(MAX)} + t_{SU:DAT} = 1000 + 250 = 1250ns before the SCL line is released.

Note 10: C_B—total capacitance of one bus line in pF.

Note 11: Minimum operating frequency of the I²C interface is imposed by the timeout period.

Note 12: The parameter t_{OSF} is the period of time the oscillator must be stopped for the OSF flag to be set over the voltage range of 0V ≤ V_{CC} ≤ V_{CC(MAX)} and 2.3V ≤ V_{BAT} ≤ 3.4V.

Note 13: This delay only applies if the oscillator is enabled and running. If the $\overline{\text{EOSC}}$ bit is 1, t_{REC} is bypassed and $\overline{\text{RST}}$ immediately goes high.

Extremely Accurate I²C RTC with Integrated Crystal and SRAM

Typical Operating Characteristics

(V_{CC} = +3.3V, T_A = +25°C, unless otherwise noted.)

DS3232

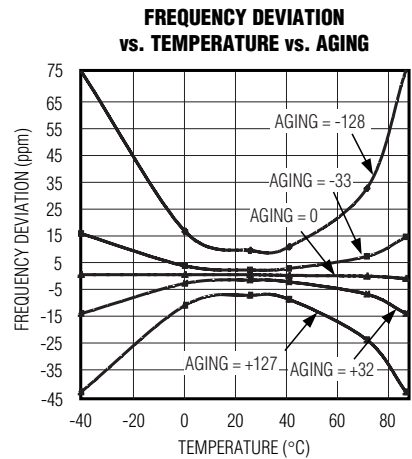
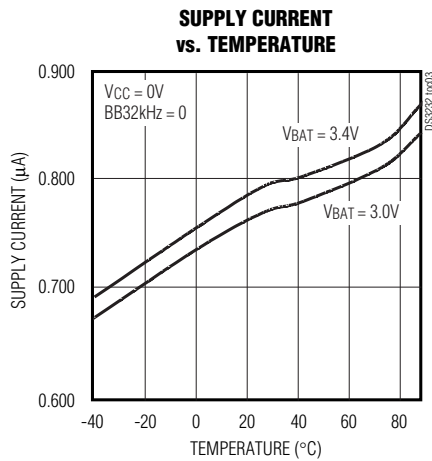
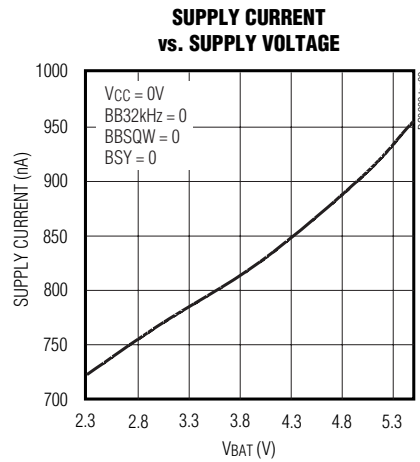
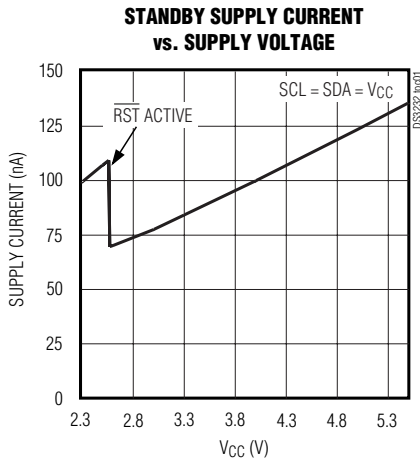

Extremely Accurate I²C RTC with Integrated Crystal and SRAM

Block Diagram

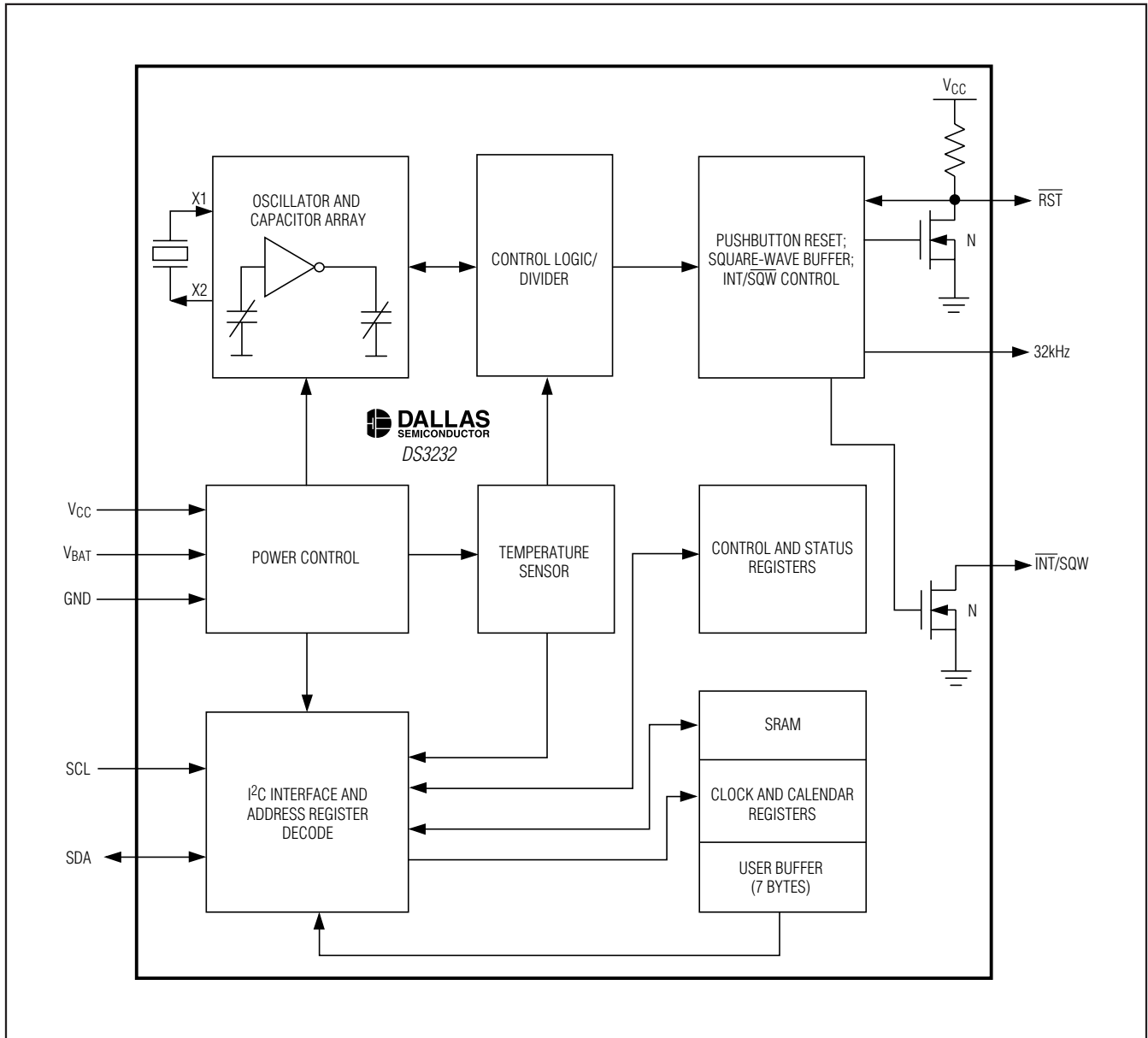

Extremely Accurate I²C RTC with Integrated Crystal and SRAM

Pin Description

DS3232

PIN	NAME	FUNCTION
1, 2, 7–14, 19	N.C.	No Connection. Not connected internally. Must be connected to ground.
3	32kHz	32kHz Push-Pull Output. If disabled with either EN32kHz = 0 or BB32kHz = 0, the state of the 32kHz pin will be low.
4	V _{CC}	DC Power Pin for Primary Power Supply. This pin should be decoupled using a 0.1μF to 1.0μF capacitor.
5	$\overline{\text{INT}}/\text{SQW}$	Active-Low Interrupt or Square-Wave Output. This open-drain pin requires an external pullup resistor. It can be left open if not used. This multifunction pin is determined by the state of the INTCN bit in the Control Register (0Eh). When INTCN is set to logic 0, this pin outputs a square wave and its frequency is determined by RS2 and RS1 bits. When INTCN is set to logic 1, then a match between the timekeeping registers and either of the alarm registers activates the $\overline{\text{INT}}/\text{SQW}$ pin (if the alarm is enabled). Because the INTCN bit is set to logic 1 when power is first applied, the pin defaults to an interrupt output with alarms disabled.
6	$\overline{\text{RST}}$	Active-Low Reset. This pin is an open-drain input/output. It indicates the status of V _{CC} relative to the V _{PF} specification. As V _{CC} falls below V _{PF} , the $\overline{\text{RST}}$ pin is driven low. When V _{CC} exceeds V _{PF} , for t _{RST} , the $\overline{\text{RST}}$ pin is driven high impedance. The active-low, open-drain output is combined with a debounced pushbutton input function. This pin can be activated by a pushbutton reset request. It has an internal 50kΩ nominal value pullup resistor to V _{CC} . No external pullup resistors should be connected. If the crystal oscillator is disabled, t _{RST} is bypassed and $\overline{\text{RST}}$ immediately goes high.
15	GND	Ground
16	V _{BAT}	Backup Power-Supply Input. This pin should be decoupled using a 0.1μF to 1.0μF low-leakage capacitor. If the I ² C interface is inactive whenever the device is powered by the V _{BAT} input, the decoupling capacitor is not required. If V _{BAT} is not used, connect to ground. Diodes placed in series between the V _{BAT} pin and the battery can cause improper operation. UL recognized to ensure against reverse charging when used with a lithium battery. Go to www.maxim-ic.com/qa/info/ul .
17	SDA	Serial-Data Input/Output. This pin is the data input/output for the I ² C serial interface. This open-drain pin requires an external pullup resistor.
18, 20	SCL	Serial-Clock Input. This pin is the clock input for the I ² C serial interface and is used to synchronize data movement on the serial interface. A connection to only one of the pins is required. The other pin must be connected to the same signal or be left floating.

Detailed Description

The DS3232 is a serial RTC driven by a temperature-compensated 32kHz crystal oscillator. The TCXO provides a stable and accurate reference clock, and maintains the RTC to within ±2 minutes per year accuracy from -40°C to +85°C. The TCXO frequency output is available at the 32kHz pin. The RTC is a low-power clock/calendar with two programmable time-of-day alarms and a programmable square-wave output. The $\overline{\text{INT}}/\text{SQW}$ provides either an interrupt signal due to alarm conditions or a square-wave output. The clock/calendar provides seconds, minutes, hours, day, date,

month, and year information. The date at the end of the month is automatically adjusted for months with fewer than 31 days, including corrections for leap year. The clock operates in either the 24-hour or 12-hour format with an AM/PM indicator. The internal registers are accessible though an I²C bus interface.

A temperature-compensated voltage reference and comparator circuit monitors the level of V_{CC} to detect power failures and to automatically switch to the backup supply when necessary. The $\overline{\text{RST}}$ pin provides an external pushbutton function and acts as an indicator of a power-fail event. Also available are 236 bytes of general-purpose battery-backed SRAM.

Extremely Accurate I²C RTC with Integrated Crystal and SRAM

Operation

The block diagram shows the main elements of the DS3232. The eight blocks can be grouped into four functional groups: TCXO, power control, pushbutton function, and RTC. Their operations are described separately in the following sections.

32kHz TCXO

The temperature sensor, oscillator, and control logic form the TCXO. The controller reads the output of the on-chip temperature sensor and uses a lookup table to determine the capacitance required, adds the aging correction in AGE register, and then sets the capacitance selection registers. New values, including changes to the AGE register, are loaded only when a change in the temperature value occurs. The temperature is read on initial application of V_{CC} and once every 64 seconds (default, see the description for CRATE1 and CRATE0 in the control/status register) afterwards.

Power Control

This function is provided by a temperature-compensated voltage reference and a comparator circuit that monitors the V_{CC} level. When V_{CC} is greater than V_{PF}, the part is powered by V_{CC}. When V_{CC} is less than V_{PF} but greater than V_{BAT}, the DS3232 is powered by V_{CC}. If V_{CC} is less than V_{PF} and is less than V_{BAT}, the device is powered by V_{BAT}. See Table 1.

Table 1. Power Control

SUPPLY CONDITION	POWERED BY
V _{CC} < V _{PF} , V _{CC} < V _{BAT}	V _{BAT}
V _{CC} < V _{PF} , V _{CC} > V _{BAT}	V _{CC}
V _{CC} > V _{PF} , V _{CC} < V _{BAT}	V _{CC}
V _{CC} > V _{PF} , V _{CC} > V _{BAT}	V _{CC}

To preserve the battery, the first time V_{BAT} is applied to the device, the oscillator does not start up and no temperature conversions take place until V_{CC} exceeds V_{PF} or until a valid I²C address is written to the part. After the first time V_{CC} is ramped up, the oscillator starts up and the V_{BAT} source powers the oscillator during power-down and keeps the oscillator running. When the DS3232 switches to V_{BAT}, the oscillator may be disabled by setting the EOSC bit.

Pushbutton Reset Function

The DS3232 provides for a pushbutton switch to be connected to the RST output pin. When the DS3232 is not in a reset cycle, it continuously monitors the RST signal for a low going edge. If an edge transition is detected, the DS3232 debounces the switch by pulling the RST low.

After the internal timer has expired (P_{BDB}), the DS3232 continues to monitor the RST line. If the line is still low, the DS3232 continuously monitors the line looking for a rising edge. Upon detecting release, the DS3232 forces the RST pin low and holds it low for t_{RST}.

The same pin, RST, is used to indicate a power-fail condition. When V_{CC} is lower than V_{PF}, an internal power-fail signal is generated, which forces the RST pin low. When V_{CC} returns to a level above V_{PF}, the RST pin is held low for t_{REC} to allow the power supply to stabilize. If the oscillator is not running (see the *Power Control* section) when V_{CC} is applied, t_{REC} is bypassed and RST immediately goes high.

Assertion of the RST output, whether by pushbutton or power-fail detection, does not affect the internal operation of the DS3232.

Real-Time Clock

With the clock source from the TCXO, the RTC provides seconds, minutes, hours, day, date, month, and year information. The date at the end of the month is automatically adjusted for months with fewer than 31 days, including corrections for leap year. The clock operates in either the 24-hour or 12-hour format with an AM/PM indicator.

The clock provides two programmable time-of-day alarms and a programmable square-wave output. The INT/SQW pin either generates an interrupt due to alarm condition or outputs a square-wave signal and the selection is controlled by the bit INTCN.

SRAM

The DS3232 provides 236 bytes of general-purpose battery-backed read/write memory. The I²C address ranges from 14h to 0FFh. The SRAM can be written or read whenever V_{CC} or V_{BAT} is greater than the minimum operating voltage.

Address Map

Figure 1 shows the address map for the DS3232 time-keeping registers. During a multibyte access, when the address pointer reaches the end of the register space (0FFh), it wraps around to location 00h. On an I²C START or address pointer incrementing to location 00h, the current time is transferred to a second set of registers. The time information is read from these secondary registers, while the clock may continue to run. This eliminates the need to reread the registers in case the main registers update during a read.

I²C Interface

The I²C interface is accessible whenever either V_{CC} or V_{BAT} is at a valid level. If a microcontroller connected to the DS3232 resets because of a loss of V_{CC} or other

Extremely Accurate I²C RTC with Integrated Crystal and SRAM

DS3232

Figure 1. Address Map for DS3232 Timekeeping Registers and SRAM

ADDRESS	BIT 7 MSB	BIT 6	BIT 5	BIT 4	BIT 3	BIT 2	BIT 1	BIT 0 LSB	FUNCTION	RANGE
00h	0	10 Seconds			Seconds				Seconds	00–59
01h	0	10 Minutes			Minutes				Minutes	00–59
02h	0	12/24	AM/PM	10 Hour	Hour				Hours	1–12 + AM/PM 00–23
03h	0	0	0	0	0	Day			Day	1–7
04h	0	0	10 Date		Date				Date	1–31
05h	Century	0	0	10 Month	Month				Month/ Century	01–12 + Century
06h	10 Year			Year				Year	00–99	
07h	A1M1	10 Seconds			Seconds				Alarm 1 Seconds	00–59
08h	A1M2	10 Minutes			Minutes				Alarm 1 Minutes	00–59
09h	A1M3	12/24	AM/PM	10 Hour	Hour				Alarm 1 Hours	1–12 + AM/PM 00–23
0Ah	A1M4	DY/DT	10 Date		Day				Alarm 1 Day	1–7
					Date				Alarm 1 Date	1–31
0Bh	A2M2	10 Minutes			Minutes				Alarm 2 Minutes	00–59
0Ch	A2M3	12/24	AM/PM	10 Hour	Hour				Alarm 2 Hours	1–12 + AM/PM 00–23
					Day				Alarm 2 Day	1–7
0Dh	A2M4	DY/DT	10 Date		Date				Alarm 2 Date	1–31
0Eh	EOSC	BBSQW	CONV	RS2	RS1	INTCN	A2IE	A1IE	Control	—
0Fh	OSF	BB32kHz	CRATE1	CRATE0	EN32kHz	BSY	A2F	A1F	Control/Status	—
10h	SIGN	DATA	DATA	DATA	DATA	DATA	DATA	DATA	Aging Offset	—
11h	SIGN	DATA	DATA	DATA	DATA	DATA	DATA	DATA	MSB of Temp	—
12h	DATA	DATA	0	0	0	0	0	0	LSB of Temp	—
13h	0	0	0	0	0	0	0	0	Not used	Reserved for test
14h–0FFh	x	x	x	x	x	x	x	x	SRAM	00h–0FFh

Note: Unless otherwise specified, the registers' state is not defined when power is first applied.

event, it is possible that the microcontroller and DS3232 I²C communications could become unsynchronized, e.g., the microcontroller resets while reading data from the DS3232. When the microcontroller resets, the DS3232 I²C interface may be placed into a known state by toggling SCL until SDA is observed to be at a high level. At that point the microcontroller should pull SDA low while SCL is high, generating a START condition.

If SCL is held low for greater than t_{IF} , the internal I²C interface is reset. This limits the minimum frequency at which the I²C interface can be operated. If data is

being written to the device when the interface timeout is exceeded, prior to the acknowledge, the incomplete byte of data is not written.

Clock and Calendar

The time and calendar information is obtained by reading the appropriate register bytes. Figure 1 illustrates the RTC registers. The time and calendar data are set or initialized by writing the appropriate register bytes. The contents of the time and calendar registers are in binary-coded decimal (BCD) format. The DS3232 can be run in either 12-hour or 24-hour mode. Bit 6 of the

Extremely Accurate I²C RTC with Integrated Crystal and SRAM

hours register is defined as the 12- or 24-hour mode select bit. When high, 12-hour mode is selected. In 12-hour mode, bit 5 is the AM/PM bit with logic-high being PM. In 24-hour mode, bit 5 is the second 10-hour bit (20–23 hours). The century bit (bit 7 of the month register) is toggled when the years register overflows from 99 to 00.

The day-of-week register increments at midnight. Values that correspond to the day of week are user-defined but must be sequential (i.e., if 1 equals Sunday, then 2 equals Monday, and so on). Illogical time and date entries result in undefined operation.

When reading or writing the time and date registers, secondary (user) buffers are used to prevent errors when the internal registers update. When reading the time and date registers, the user buffers are synchronized to the internal registers on any START and when the register pointer rolls over to zero. The time information is read from these secondary registers, while the clock continues to run. This eliminates the need to reread the registers in case the main registers update during a read.

The countdown chain is reset whenever the seconds register is written. Write transfers occur on the acknowledge from the DS3232. Once the countdown chain is reset, to avoid rollover issues the remaining time and date registers must be written within 1 second. The 1Hz square-wave output, if enabled, transitions high 500ms after the seconds data transfer, provided the oscillator is already running.

Alarms

The DS3232 contains two time-of-day/date alarms. Alarm 1 can be set by writing to registers 07h to 0Ah. Alarm 2 can be set by writing to registers 0Bh to 0Dh. The alarms can be programmed (by the alarm enable and INTCN bits of the control register) to activate the $\overline{\text{INT}}/\text{SQW}$ output on an alarm match condition. Bit 7 of each of the time-of-day/date alarm registers are mask bits (Table 2). When all the mask bits for each alarm are logic 0, an alarm only occurs when the values in the timekeeping registers match the corresponding values stored in the time-of-day/date alarm registers. The alarms can also be programmed to repeat every second, minute, hour, day, or date. Table 2 shows the possible settings. Configurations not listed in the table result in illogical operation.

The DY/ $\overline{\text{DT}}$ bits (bit 6 of the alarm day/date registers) control whether the alarm value stored in bits 0 to 5 of that register reflects the day of the week or the date of the month. If DY/ $\overline{\text{DT}}$ is written to logic 0, the alarm will be the result of a match with date of the month. If DY/ $\overline{\text{DT}}$ is written to logic 1, the alarm will be the result of a match with day of the week.

When the RTC register values match alarm register settings, the corresponding Alarm Flag 'A1F' or 'A2F' bit is set to logic 1. If the corresponding Alarm Interrupt Enable 'A1IE' or 'A2IE' is also set to logic 1 and the INTCN bit is set to logic 1, the alarm condition activates the $\overline{\text{INT}}/\text{SQW}$ signal. The match is tested on the once-per-second update of the time and date registers.

Table 2. Alarm Mask Bits

DY/ $\overline{\text{DT}}$	ALARM 1 REGISTER MASK BITS (BIT 7)				ALARM RATE
	A1M4	A1M3	A1M2	A1M1	
X	1	1	1	1	Alarm once per second
X	1	1	1	0	Alarm when seconds match
X	1	1	0	0	Alarm when minutes and seconds match
X	1	0	0	0	Alarm when hours, minutes, and seconds match
0	0	0	0	0	Alarm when date, hours, minutes, and seconds match
1	0	0	0	0	Alarm when day, hours, minutes, and seconds match
DY/ $\overline{\text{DT}}$	ALARM 2 REGISTER MASK BITS (BIT 7)			ALARM RATE	
	A2M4	A2M3	A2M2		
X	1	1	1	Alarm once per minute (00 seconds of every minute)	
X	1	1	0	Alarm when minutes match	
X	1	0	0	Alarm when hours and minutes match	
0	0	0	0	Alarm when date, hours, and minutes match	
1	0	0	0	Alarm when day, hours, and minutes match	

Extremely Accurate I²C RTC with Integrated Crystal and SRAM

DS3232

Control Register (0Eh)

	BIT 7	BIT 6	BIT 5	BIT 4	BIT 3	BIT 2	BIT 1	BIT 0
NAME:	$\overline{\text{EOSC}}$	BBSQW	CONV	RS2	RS1	INTCN	A2IE	A1IE
POR*:	0	0	0	1	1	1	0	0

*POR is defined as the first application of power to the device, either V_{BAT} or V_{CC}.

Special-Purpose Registers

The DS3232 has two additional registers (control and control/status) that control the real-time clock, alarms, and square-wave output.

Control Register (0Eh)

Bit 7: Enable Oscillator ($\overline{\text{EOSC}}$). When set to logic 0, the oscillator is started. When set to logic 1, the oscillator is stopped when the DS3232 switches to battery power. This bit is clear (logic 0) when power is first applied. When the DS3232 is powered by V_{CC}, the oscillator is always on regardless of the status of the $\overline{\text{EOSC}}$ bit.

Bit 6: Battery-Backed Square-Wave Enable (BBSQW). When set to logic 1 and the DS3232 is being powered by the V_{BAT} pin, this bit enables the square-wave output or interrupt when V_{CC} is absent. When BBSQW is logic 0, the $\overline{\text{INT/SQW}}$ pin goes high impedance when V_{CC} falls below the power-fail trip point. This bit is disabled (logic 0) when power is first applied.

Bit 5: Convert Temperature (CONV). Setting this bit to 1 forces the temperature sensor to convert the temperature into digital code and execute the TCXO algorithm to update the capacitance array to the oscillator. This can only happen when a conversion is not already in progress. The user should check the status bit BSY before forcing the controller to start a new TCXO execution. A user-initiated temperature conversion does not affect the internal 64-second (default interval) update cycle.

A user-initiated temperature conversion does not affect the BSY bit for approximately 2ms. The CONV bit remains at a 1 from the time it is written until the conversion is finished, at which time both CONV and BSY go to 0. The CONV bit should be used when monitoring the status of a user-initiated conversion.

Bits 4 and 3: Rate Select (RS2 and RS1). These bits control the frequency of the square-wave output when the square wave has been enabled. The following table shows the square-wave frequencies that can be selected with the RS bits. These bits are both set to logic 1 (8.192kHz) when power is first applied.

SQUARE-WAVE OUTPUT FREQUENCY

RS2	RS1	SQUARE-WAVE OUTPUT FREQUENCY
0	0	1Hz
0	1	1.024kHz
1	0	4.096kHz
1	1	8.192kHz

Bit 2: Interrupt Control (INTCN). This bit controls the $\overline{\text{INT/SQW}}$ signal. When the INTCN bit is set to logic 0, a square wave is output on the $\overline{\text{INT/SQW}}$ pin. When the INTCN bit is set to logic 1, a match between the time-keeping registers and either of the alarm registers activates the $\overline{\text{INT/SQW}}$ (if the alarm is also enabled). The corresponding alarm flag is always set regardless of the state of the INTCN bit. The INTCN bit is set to logic 1 when power is first applied.

Bit 1: Alarm 2 Interrupt Enable (A2IE). When set to logic 1, this bit permits the alarm 2 flag (A2F) bit in the status register to assert $\overline{\text{INT/SQW}}$ (when INTCN = 1). When the A2IE bit is set to logic 0 or INTCN is set to logic 0, the A2F bit does not initiate an interrupt signal. The A2IE bit is disabled (logic 0) when power is first applied.

Bit 0: Alarm 1 Interrupt Enable (A1IE). When set to logic 1, this bit permits the alarm 1 flag (A1F) bit in the status register to assert $\overline{\text{INT/SQW}}$ (when INTCN = 1). When the A1IE bit is set to logic 0 or INTCN is set to logic 0, the A1F bit does not initiate the $\overline{\text{INT/SQW}}$ signal. The A1IE bit is disabled (logic 0) when power is first applied.

Extremely Accurate I²C RTC with Integrated Crystal and SRAM

Control/Status Register (0Fh)

	BIT 7	BIT 6	BIT 5	BIT 4	BIT 3	BIT 2	BIT 1	BIT 0
NAME:	OSF	BB32kHz	CRATE1	CRATE0	EN32kHz	BSY	A2F	A1F
POR*:	1	1	0	0	1	0	0	0

*POR is defined as the first application of power to the device, either V_{BAT} or V_{CC}.

Control/Status Register (0Fh)

Bit 7: Oscillator Stop Flag (OSF). A logic 1 in this bit indicates that the oscillator either is stopped or was stopped for some period and may be used to judge the validity of the timekeeping data. This bit is set to logic 1 any time that the oscillator stops. The following are examples of conditions that can cause the OSF bit to be set:

- 1) The first time power is applied.
- 2) The voltages present on both V_{CC} and V_{BAT} are insufficient to support oscillation.
- 3) The $\overline{\text{EOSC}}$ bit is turned off in battery-backed mode.
- 4) External influences on the crystal (i.e., noise, leakage, etc.).

This bit remains at logic 1 until written to logic 0.

Bit 6: Battery-Backed 32kHz Output (BB32kHz). This bit enables the 32kHz output when powered from V_{BAT} (provided EN32kHz is enabled). If BB32kHz = 0, the 32kHz output is low when the part is powered by V_{BAT}.

Bits 5 and 4: Conversion Rate (CRATE1 and CRATE0). These two bits control the sample rate of the TCXO. The sample rate determines how often the temperature sensor makes a conversion and applies compensation to the oscillator. Decreasing the sample rate decreases the overall power consumption by decreasing the frequency at which the temperature sensor operates. However, significant temperature changes that occur between samples may not be completely compensated for, which reduce overall accuracy. When a new conversion rate is written to the register, it may take up to the new conversion rate time before the conversions occur at the new rate.

CRATE1	CRATE0	SAMPLE RATE (seconds)
0	0	64
0	1	128
1	0	256
1	1	512

Bit 3: Enable 32kHz Output (EN32kHz). This bit indicates the status of the 32kHz pin. When set to logic 1, the 32kHz pin is enabled and outputs a 32.768kHz square-wave signal. When set to logic 0, the 32kHz pin goes low. The initial power-up state of this bit is logic 1, and a 32.768kHz square-wave signal appears at the 32kHz pin after a power source is applied to the DS3232 (if the oscillator is running).

Bit 2: Busy (BSY). This bit indicates the device is busy executing TCXO functions. It goes to logic 1 when the conversion signal to the temperature sensor is asserted and then is cleared when the conversion is complete.

Bit 1: Alarm 2 Flag (A2F). A logic 1 in the alarm 2 flag bit indicates that the time matched the alarm 2 registers. If the A2IE bit is logic 1 and the INTCN bit is set to logic 1, the $\overline{\text{INT/SQW}}$ pin is also asserted. A2F is cleared when written to logic 0. This bit can only be written to logic 0. Attempting to write to logic 1 leaves the value unchanged.

Bit 0: Alarm 1 Flag (A1F). A logic 1 in the alarm 1 flag bit indicates that the time matched the alarm 1 registers. If the A1IE bit is logic 1 and the INTCN bit is set to logic 1, the $\overline{\text{INT/SQW}}$ pin is also asserted. A1F is cleared when written to logic 0. This bit can only be written to logic 0. Attempting to write to logic 1 leaves the value unchanged.

Extremely Accurate I²C RTC with Integrated Crystal and SRAM

DS3232

Aging Offset (10h)

	BIT 7	BIT 6	BIT 5	BIT 4	BIT 3	BIT 2	BIT 1	BIT 0
NAME:	SIGN	DATA	DATA	DATA	DATA	DATA	DATA	DATA
POR*:	0	0	0	0	0	0	0	0

Temperature Register (Upper Byte) (11h)

	BIT 7	BIT 6	BIT 5	BIT 4	BIT 3	BIT 2	BIT 1	BIT 0
NAME:	SIGN	DATA	DATA	DATA	DATA	DATA	DATA	DATA
POR*:	0	0	0	0	0	0	0	0

Temperature Register (Lower Byte) (12h)

	BIT 7	BIT 6	BIT 5	BIT 4	BIT 3	BIT 2	BIT 1	BIT 0
NAME:	DATA	DATA	0	0	0	0	0	0
POR*:	0	0	0	0	0	0	0	0

SRAM (14h–FFh)

	BIT 7	BIT 6	BIT 5	BIT 4	BIT 3	BIT 2	BIT 1	BIT 0
NAME:	D7	D6	D5	D4	D3	D2	D1	D0
POR*:	X	X	X	X	X	X	X	X

*POR is defined as the first application of power to the device, either VBAT or VCC.

Aging Offset Register

The aging offset register provides an 8-bit code to add to or subtract from the oscillator capacitor array. The data is encoded in two's complement, with bit 7 representing the sign bit. One LSB represents the smallest capacitor to be switched in or out of the capacitance array at the crystal pins. The offset register is added to the capacitance array during a normal temperature conversion, if the temperature changes from the previous conversion, or during a manual user conversion (setting the CONV bit). To see the effects of the aging register on the 32kHz output frequency immediately, a manual conversion should be started after each aging offset register change.

Positive aging values add capacitance to the array, slowing the oscillator frequency. Negative values remove capacitance from the array, increasing the oscillator frequency.

The change in ppm per LSB is different at different temperatures. The frequency vs. temperature curve is shifted by the values used in this register. At +25°C, one LSB typically provides about 0.1ppm change in frequency.

Temperature Registers (11h–12h)

Temperature is represented as a 10-bit code with a resolution of +0.25°C and is accessible at location 11h and 12h. The temperature is encoded in two's complement format, with bit 7 in the MSB representing the sign bit. The upper 8 bits are at location 11h and the lower 2 bits are in the upper nibble at location 12h. Upon power reset, the registers are set to a default temperature of 0°C and the controller starts a temperature conversion. New temperature readings are stored in this register.

I²C Serial Data Bus

The DS3232 supports a bidirectional I²C bus and data transmission protocol. A device that sends data onto the bus is defined as a transmitter and a device receiving data is defined as a receiver. The device that controls the message is called a master. The devices that are controlled by the master are slaves. The bus must be controlled by a master device that generates the serial clock (SCL), controls the bus access, and generates the START and STOP conditions. The DS3232 operates as a slave on the I²C bus. Connections to the bus are made through the SCL input and open-drain SDA I/O lines. Within the bus specifications, a standard mode (100kHz maximum clock rate) and a fast mode (400kHz maximum clock rate) are defined. The DS3232 works in both modes.

Extremely Accurate I²C RTC with Integrated Crystal and SRAM

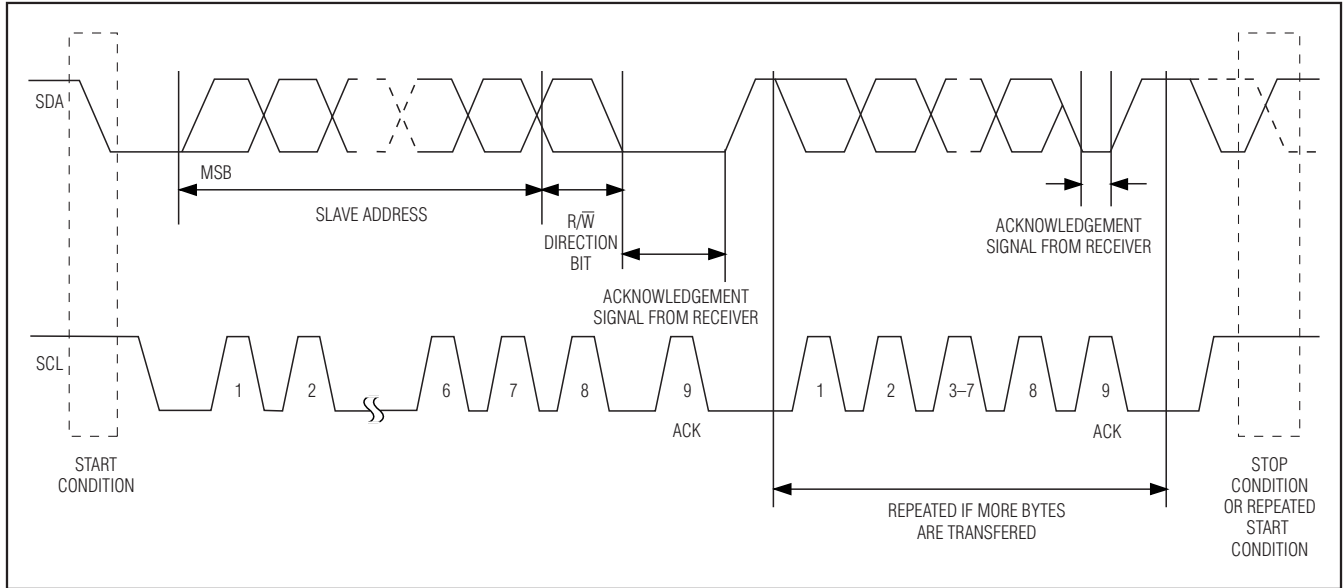

Figure 2. I²C Data Transfer Overview

The following bus protocol has been defined (Figure 2):

- Data transfer may be initiated only when the bus is not busy.
- During data transfer, the data line must remain stable whenever the clock line is high. Changes in the data line while the clock line is high are interpreted as control signals.

Accordingly, the following bus conditions have been defined:

Bus not busy: Both data and clock lines remain high.

Start data transfer: A change in the state of the data line from high to low, while the clock line is high, defines a START condition.

Stop data transfer: A change in the state of the data line from low to high, while the clock line is high, defines a STOP condition.

Data valid: The state of the data line represents valid data when, after a START condition, the data line is stable for the duration of the high period of the clock signal. The data on the line must be changed during the low period of the clock signal. There is one clock pulse per bit of data.

Each data transfer is initiated with a START condition and terminated with a STOP condition. The number of data bytes transferred between the START and

the STOP conditions is not limited, and is determined by the master device. The information is transferred byte-wise and each receiver acknowledges with a ninth bit.

Acknowledge: Each receiving device, when addressed, is obliged to generate an acknowledge after the reception of each byte. The master device must generate an extra clock pulse, which is associated with this acknowledge bit.

A device that acknowledges must pull down the SDA line during the acknowledge clock pulse in such a way that the SDA line is stable low during the high period of the acknowledge-related clock pulse. Of course, setup and hold times must be taken into account. A master must signal an end of data to the slave by not generating an acknowledge bit on the last byte that has been clocked out of the slave. In this case, the slave must leave the data line high to enable the master to generate the STOP condition.

Figures 3 and 4 detail how data transfer is accomplished on the I²C bus. Depending upon the state of the R/W bit, two types of data transfer are possible:

Data transfer from a master transmitter to a slave receiver. The first byte transmitted by the master is the slave address. Next follows a number of data bytes. The slave returns an acknowledge bit after each received byte. Data is transferred with the most significant bit (MSB) first.

Extremely Accurate I²C RTC with Integrated Crystal and SRAM

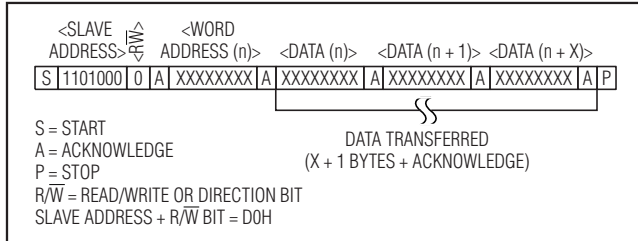

Figure 3. Slave Receiver Mode (Write Mode)

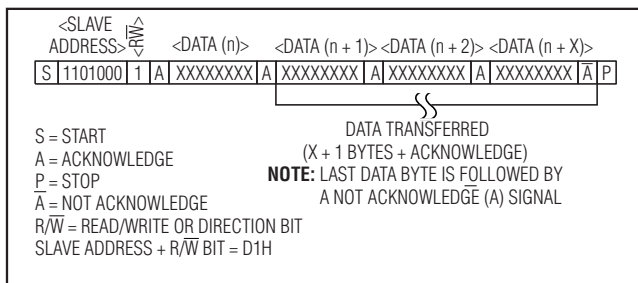

Figure 4. Slave Transmitter Mode (Read Mode)

Data transfer from a slave transmitter to a master receiver. The first byte (the slave address) is transmitted by the master. The slave then returns an acknowledge bit. Next follows a number of data bytes transmitted by the slave to the master. The master returns an acknowledge bit after all received bytes other than the last byte. At the end of the last received byte, a not acknowledge is returned.

The master device generates all the serial clock pulses and the START and STOP conditions. A transfer is ended with a STOP condition or with a repeated START condition. Since a repeated START condition is also the beginning of the next serial transfer, the bus will not be released. Data is transferred with the most significant bit (MSB) first.

The DS3232 can operate in the following two modes:

Slave receiver mode (DS3232 write mode): Serial data and clock are received through SDA and SCL. After each byte is received, an acknowledge bit is transmitted. START and STOP conditions are recognized as the beginning and end of a serial transfer. Address recognition is performed by hardware after reception of the slave address and direction bit. The slave address byte is the first byte received after the master generates the START condition. The slave address byte contains the 7-bit DS3232 address,

which is 1101000, followed by the direction bit ($\overline{R/W}$), which is 0 for a write. After receiving and decoding the slave address byte, the DS3232 outputs an acknowledge on SDA. After the DS3232 acknowledges the slave address + write bit, the master transmits a word address to the DS3232. This sets the register pointer on the DS3232, with the DS3232 acknowledging the transfer. The master may then transmit zero or more bytes of data, with the DS3232 acknowledging each byte received. The register pointer increments after each data byte is transferred. The master generates a STOP condition to terminate the data write.

Slave transmitter mode (DS3232 read mode): The first byte is received and handled as in the slave receiver mode. However, in this mode, the direction bit indicates that the transfer direction is reversed. Serial data is transmitted on SDA by the DS3232 while the serial clock is input on SCL. START and STOP conditions are recognized as the beginning and end of a serial transfer. Address recognition is performed by hardware after reception of the slave address and direction bit. The slave address byte is the first byte received after the master generates a START condition. The slave address byte contains the 7-bit DS3232 address, which is 1101000, followed by the direction bit ($\overline{R/W}$), which is 1 for a read. After receiving and decoding the slave address byte, the DS3232 outputs an acknowledge on SDA. The DS3232 then begins to transmit data starting with the register address pointed to by the register pointer. If the register pointer is not written to before the initiation of a read mode, the first address that is read is the last one stored in the register pointer. The DS3232 must receive a not acknowledge to end a read.

Handling, PC Board Layout, and Assembly

The DS3232 package contains a quartz tuning-fork crystal. Pick-and-place equipment can be used, but precautions should be taken to ensure that excessive shocks are avoided. Exposure to reflow is limited to 2 times maximum. Ultrasonic cleaning should be avoided to prevent damage to the crystal.

Avoid running signal traces under the package, unless a ground plane is placed between the package and the signal line. All N.C. (no connect) pins must be connected to ground.

Extremely Accurate I²C RTC with Integrated Crystal and SRAM

Chip Information

TRANSISTOR COUNT: 48,000
 SUBSTRATE CONNECTED TO GROUND
 PROCESS: CMOS

Thermal Information

Theta-JA: +55.1°C/W
 Theta-JC: +24°C/W

Package Information

(For the latest package outline information, go to www.maxim-ic.com/DallasPackInfo.)

PACKAGE TYPE	DOCUMENT NO.
20 SO	56-G4009-001

Revision History

Pages changed at Rev 1: 1
 Pages changed at Rev 2: 1, 4, 7, 11, 14, 17
 Pages changed at Rev 3: 1, 3, 9, 10, 11, 18

Maxim cannot assume responsibility for use of any circuitry other than circuitry entirely embodied in a Maxim product. No circuit patent licenses are implied. Maxim reserves the right to change the circuitry and specifications without notice at any time.

18 **Maxim Integrated Products, 120 San Gabriel Drive, Sunnyvale, CA 94086 408-737-7600**

© 2007 Maxim Integrated Products

MAXIM is a registered trademark of Maxim Integrated Products, Inc.

DALLAS SEMICONDUCTOR is a registered trademark of Dallas Semiconductor Corporation.