

## Positive Voltage Regulators (Output ON/OFF)

### ■ GENERAL DESCRIPTION

The XC62H series are highly precise, low power consumption, positive voltage regulators, manufactured using CMOS and laser trimming technologies. The series consists of a high precision voltage reference, an error correction circuit, and an output driver with current limitation.

By way of the CE function, with output turned off, the series enters standby. In the stand-by mode, power consumption is greatly reduced.

SOT-25 (150mW), SOT-89-5 (500mW) and USP-6B (100mW) packages are available.

In relation to the CE function, as well as the positive logic XC62HR series, a negative logic XC62HP series (custom) is also available.

### ■ APPLICATIONS

- Battery powered equipment
- Voltage supplies for cellular phones
- Cameras, Video recorders
- Palmtops

### ■ FEATURES

#### Maximum Output Current

: 165mA (within max.power  
dissipation,  $V_{OUT}=3.0V$ )

**Output Voltage Range** : 2.0V ~ 6.0V in 100mV increments  
(1.5V ~ 1.9V semi-custom)

**Highly Accurate** : Set-up Voltage  $\pm 2\%$   
( $\pm 1\%$  for semi-custom products)

#### Low Power Consumption

: 3.0  $\mu A$  (TYP.) ( $V_{OUT}=3.0$ , Output enabled)

: 0.1  $\mu A$  (TYP.) (Output disabled)

#### Output Voltage Temperature Characteristics

:  $\pm 100$ ppm / $^{\circ}C$  (TYP.)

**Line Regulation** : 0.2% / V (TYP.)

#### CMOS Low Power Consumption

**Small Dropout** : 0.18V @ 60mA

: 0.58V @ 160mA

**Ultra Small Packages** : SOT-25 (150mW) mini-mold

SOT-89-5 (500mW) mini-power mold

USP-6B (100mW)

### ■ TYPICAL APPLICATION CIRCUIT

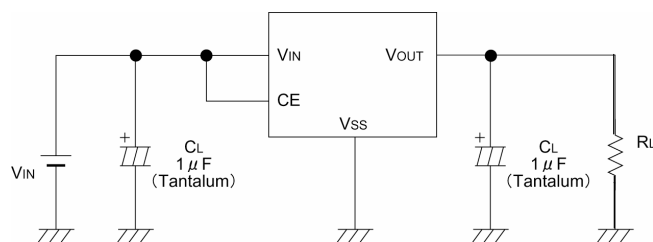

### ■ TYPICAL PERFORMANCE CHARACTERISTICS

XC62HR3002 (3V)

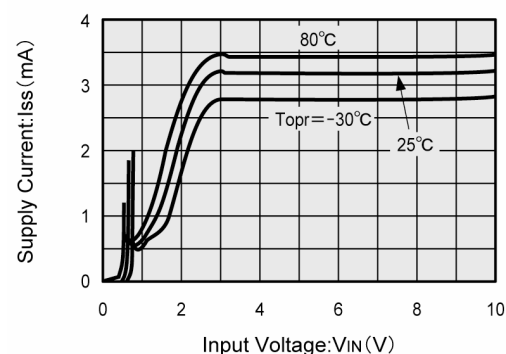

## PIN CONFIGURATION

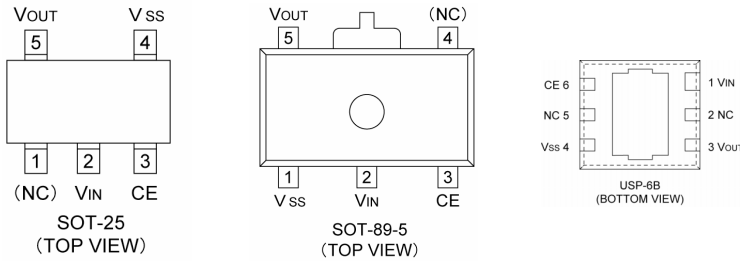

\*The dissipation pad for the USP-6B package should be solder-plated in recommended mount pattern and metal masking so as to enhance mounting strength and heat release. If the pad needs to be connected to other pins, it should be connected to the VIN pin.

## PIN ASSIGNMENT

PIN NUMBER			PIN NAME	FUNCTION
SOT-25	SOT-89-5	USP-6B		
1	4	2, 5	(NC)	No Connection
2	2	1	VIN	Supply Voltage Input
3	3	6	CE	Chip Enable
4	1	4	VSS	Ground
5	5	3	VOUT	Regulated Output Voltage

## FUNCTION

SERIES	CE	VOLTAGE OUTPUT
XC62HR	H	ON
	L	OFF
XC62HP	H	OFF
	L	ON

H = High level  
L = Low level

## PRODUCT CLASSIFICATION

### Ordering Information

XC62H①②③④⑤⑥⑦

DESIGNATOR	DESCRIPTION	SYMBOL	DESCRIPTION
①	CE Pin Logic	R	: Positive
		P	: Negative (Custom)
② ③	Output Voltage	20~60	: e.g. VOUT 3.0V → ②=3, ③=0 VOUT 5.0V → ②=5, ③=0
④	Temperature Characteristics	0	: ± 100ppm (TYP.)
⑤	Output Voltage Accuracy	1	: ± 1% (semi-custom)
		2	: ± 2%
⑥	Package Type	M	: SOT-23
		P	: SOT-89-5
		D	: USP-6B
⑦	Device Orientation	R	: Embossed tape, standard feed
		L	: Embossed tape, reverse feed

■ BLOCK DIAGRAM

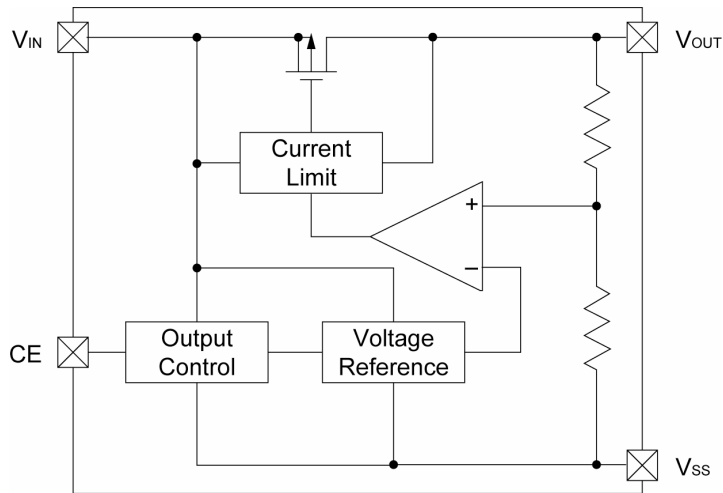

## ABSOLUTE MAXIMUM RATINGS

Ta=25°C

PARAMETER	SYMBOL	RATINGS	UNITS
Input Voltage	V <sub>IN</sub>	12.0	V
Output Current	I <sub>OUT</sub>	500	mA
Output Voltage	V <sub>OUT</sub>	V <sub>SS</sub> -0.3 ~ V <sub>IN</sub> +1.3	V
CE Input Voltage	V <sub>CE</sub>	V <sub>SS</sub> -0.3 ~ V <sub>IN</sub> +1.3	V
Power Dissipation	SOT-25	150	mW
	SOT-89-5	500	
	USP-6B	100	
Operating Temperature Range	T <sub>opr</sub>	-30 ~ +80	°C
Storage Temperature Range	T <sub>stg</sub>	-40 ~ +25	°C

## ELECTRICAL CHARACTERISTICS

XC62HR2002 V<sub>OUT(T)</sub>=2.0V <sup>(\*1)</sup>

Ta=25°C

PARAMETER	SYMBOL	CONDITIONS	MIN.	TYP.	MAX.	UNITS	CIRCUIT
Output Voltage	V <sub>OUT(E)</sub> <sup>(*2)</sup>	I <sub>OUT</sub> =40mA V <sub>IN</sub> =3.0V	1,960	2,000	2,040	V	1
Maximum Output Current	I <sub>OUT max</sub>	V <sub>IN</sub> =3.0V, V <sub>OUT(E)</sub> ≥ 1.8V	115	-	-	mA	1
Load Regulation	ΔV <sub>OUT</sub>	V <sub>IN</sub> =3.0V 1mA ≤ I <sub>OUT</sub> ≤ 60mA	-	45	90	mV	1
Dropout Voltage <sup>(*3)</sup>	V <sub>dif1</sub>	I <sub>OUT</sub> =40mA	-	180	360	mV	1
	V <sub>dif2</sub>	I <sub>OUT</sub> =100mA	-	580	880	mV	1
Supply Current 1	I <sub>SS1</sub>	V <sub>IN</sub> =V <sub>CE</sub> =3.0V	-	2.9	7.9	μA	2
Supply Current 2	I <sub>SS2</sub>	V <sub>IN</sub> =3.0V, V <sub>CE</sub> =V <sub>SS</sub>	-	-	0.1	μA	2
Line Regulation	$\frac{\Delta V_{OUT}}{\Delta V_{IN} \cdot \Delta V_{OUT}}$	I <sub>OUT</sub> =40mA 3.0V ≤ V <sub>IN</sub> ≤ 10.0V	-	0.2	0.3	% / V	1
Input Voltage	ΔV <sub>IN</sub>		-	-	10.0	V	-
Output Voltage Temperature Characteristics	$\frac{\Delta V_{OUT}}{\Delta T_{opr} \cdot \Delta V_{OUT}}$	I <sub>OUT</sub> =40mA -30°C ≤ T <sub>opr</sub> ≤ 80°C	-	±100	-	ppm / °C	1
CE "High" Voltage	V <sub>CEH</sub>		1.5	-	-	V	1
CE "Low" Voltage	V <sub>CEL</sub>		-	-	0.25	V	1
CE "High" Current	I <sub>CEH</sub>	V <sub>CE</sub> =V <sub>IN</sub>	-	-	0.1	μA	2
CE "Low" Current	I <sub>CEL</sub>	V <sub>CE</sub> =V <sub>SS</sub>	-0.2	-0.05	0	μA	2

NOTE:

\*1: V<sub>OUT(T)</sub>=Specified output voltage .

\*2: V<sub>OUT(E)</sub>=Effective output voltage (i.e. the output voltage when "V<sub>OUT(T)</sub>+1.0V" is provided at the V<sub>IN</sub> pin while maintaining a certain I<sub>OUT</sub> value).

\*3: V<sub>dif</sub>= {V<sub>IN1</sub> <sup>(\*5)</sup> - V<sub>OUT1</sub> <sup>(\*4)</sup>}

\*4: V<sub>OUT1</sub>= A voltage equal to 98% of the output voltage whenever an amply stabilized I<sub>OUT</sub> {V<sub>OUT(T)</sub>+1.0V} is input.

\*5: V<sub>IN1</sub>= The input voltage when V<sub>OUT1</sub> appears as input voltage is gradually decreased.

## ■ ELECTRICAL CHARACTERISTICS (Continued)

XC62HR3002  $V_{OUT(T)}=3.0V$  <sup>(\*1)</sup>

$T_a=25^\circ C$

PARAMETER	SYMBOL	CONDITIONS	MIN.	TYP.	MAX.	UNITS	CIRCUIT
Output Voltage	$V_{OUT(E)}$ <sup>(*2)</sup>	$I_{OUT}=40mA$ $V_{IN}=4.0V$	2,940	3,000	3,060	V	1
Maximum Output Current	$I_{OUT\ max}$	$V_{IN}=4.0V, V_{OUT(E)} \geq 2.7V$	165	-	-	mA	1
Load Regulation	$\Delta V_{OUT}$	$V_{IN}=4.0V$ $1mA \leq I_{OUT} \leq 80mA$	-	45	90	mV	1
Dropout Voltage <sup>(*3)</sup>	Vdif1	$I_{OUT}=60mA$	-	180	360	mV	1
	Vdif2	$I_{OUT}=160mA$	-	580	880	mV	1
Supply Current 1	ISS1	$V_{IN}=V_{CE}=4.0V$	-	3.0	8.0	$\mu A$	2
Supply Current 2	ISS2	$V_{IN}=4.0V, V_{CE}=V_{SS}$	-	-	0.1	$\mu A$	2
Line Regulation	$\frac{\Delta V_{OUT}}{\Delta V_{IN} \cdot \Delta V_{OUT}}$	$I_{OUT}=40mA$ $4.0V \leq V_{IN} \leq 10.0V$	-	0.2	0.3	% / V	1
Input Voltage	$\Delta V_{IN}$		-	-	10.0	V	-
Output Voltage Temperature Characteristics	$\frac{\Delta V_{OUT}}{\Delta T_{opr} \cdot \Delta V_{OUT}}$	$I_{OUT}=40mA$ $-30^\circ C \leq T_{opr} \leq 80^\circ C$	-	$\pm 100$	-	ppm / $^\circ C$	1
CE "High" Voltage	$V_{CEH}$		1.5	-	-	V	1
CE "Low" Voltage	$V_{CEL}$		-	-	0.25	V	1
CE "High" Current	$I_{CEH}$	$V_{CE}=V_{IN}$	-	-	0.1	$\mu A$	2
CE "Low" Current	$I_{CEL}$	$V_{CE}=V_{SS}$	-0.2	-0.05	0	$\mu A$	2

XC62HR4002  $V_{OUT(T)}=4.0V$  <sup>(\*1)</sup>

$T_a=25^\circ C$

PARAMETER	SYMBOL	CONDITIONS	MIN.	TYP.	MAX.	UNITS	CIRCUIT
Output Voltage	$V_{OUT(E)}$ <sup>(*2)</sup>	$I_{OUT}=40mA$ $V_{IN}=5.0V$	3,920	4,000	4,080	V	1
Maximum Output Current	$I_{OUT\ max}$	$V_{IN}=5.0V, V_{OUT(E)} \geq 3.6V$	200	-	-	mA	1
Load Regulation	$\Delta V_{OUT}$	$V_{IN}=5.0V$ $1mA \leq I_{OUT} \leq 100mA$	-	45	90	mV	1
Dropout Voltage <sup>(*3)</sup>	Vdif1	$I_{OUT}=80mA$	-	170	340	mV	1
	Vdif2	$I_{OUT}=180mA$	-	560	840	mV	1
Supply Current 1	ISS1	$V_{IN}=V_{CE}=5.0V$	-	3.1	8.1	$\mu A$	2
Supply Current 2	ISS2	$V_{IN}=5.0V, V_{CE}=V_{SS}$	-	-	0.1	$\mu A$	2
Line Regulation	$\frac{\Delta V_{OUT}}{\Delta V_{IN} \cdot \Delta V_{OUT}}$	$I_{OUT}=40mA$ $5.0V \leq V_{IN} \leq 10.0V$	-	0.2	0.3	% / V	1
Input Voltage	$\Delta V_{IN}$		-	-	10.0	V	-
Output Voltage Temperature Characteristics	$\frac{\Delta V_{OUT}}{\Delta T_{opr} \cdot \Delta V_{OUT}}$	$I_{OUT}=40mA$ $-30^\circ C \leq T_{opr} \leq 80^\circ C$	-	$\pm 100$	-	ppm / $^\circ C$	1
CE "High" Voltage	$V_{CEH}$		1.5	-	-	V	1
CE "Low" Voltage	$V_{CEL}$		-	-	0.25	V	1
CE "High" Current	$I_{CEH}$	$V_{CE}=V_{IN}$	-	-	0.1	$\mu A$	2
CE "Low" Current	$I_{CEL}$	$V_{CE}=V_{SS}$	-0.2	-0.05	0	$\mu A$	2

**NOTE:**

\*1:  $V_{OUT(T)}$ =Specified output voltage .

\*2:  $V_{OUT(E)}$ =Effective output voltage (i.e. the output voltage when " $V_{OUT(T)}+1.0V$ " is provided at the  $V_{IN}$  pin while maintaining a certain  $I_{OUT}$  value).

\*3:  $V_{dif} = \{V_{IN1}^{(*5)} - V_{OUT1}^{(*4)}\}$

\*4:  $V_{OUT1}$ = A voltage equal to 98% of the output voltage whenever an amply stabilized  $I_{OUT}$   $\{V_{OUT(T)}+1.0V\}$  is input.

\*5:  $V_{IN1}$ = The input voltage when  $V_{OUT1}$  appears as input voltage is gradually decreased.

## ELECTRICAL CHARACTERISTICS (Continued)

XC62HR5002  $V_{OUT(T)}=5.0V$  <sup>(\*1)</sup>

$T_a=25^{\circ}C$

PARAMETER	SYMBOL	CONDITIONS	MIN.	TYP.	MAX.	UNITS	CIRCUIT
Output Voltage	$V_{OUT(E)}$ <sup>(*2)</sup>	$I_{OUT}=40mA$ $V_{IN}=6.0V$	4,900	5,000	5,100	V	1
Maximum Output Current	$I_{OUT\ max}$	$V_{IN}=6.0V, V_{OUT(E)} \geq 4.5V$	220	-	-	mA	1
Load Regulation	$\Delta V_{OUT}$	$V_{IN}=6.0V$ $1mA \leq I_{OUT} \leq 100mA$	-	40	80	mV	1
Dropout Voltage <sup>(*3)</sup>	$V_{dif1}$	$I_{OUT}=100mA$	-	165	320	mV	1
	$V_{dif2}$	$I_{OUT}=200mA$	-	540	820	mV	1
Supply Current1	$I_{SS1}$	$V_{IN}=V_{CE}=6.0V$	-	3.1	8.1	$\mu A$	2
Supply Current2	$I_{SS2}$	$V_{IN}=6.0V, V_{CE}=V_{SS}$	-	-	0.1	$\mu A$	2
Line Regulation	$\frac{\Delta V_{OUT}}{\Delta V_{IN} \cdot \Delta V_{OUT}}$	$I_{OUT}=40mA$ $6.0V \leq V_{IN} \leq 10.0V$	-	0.2	0.3	% / V	1
Input Voltage	$\Delta V_{IN}$		-	-	10.0	V	-
Output Voltage Temperature Characteristics	$\frac{\Delta V_{OUT}}{\Delta T_{opr} \cdot \Delta V_{OUT}}$	$I_{OUT}=40mA$ $-30^{\circ}C \leq T_{opr} \leq 80^{\circ}C$	-	$\pm 100$	-	ppm / $^{\circ}C$	1
CE "High" Voltage	$V_{CEH}$		1.5	-	-	V	1
CE "Low" Voltage	$V_{CEL}$		-	-	0.25	V	1
CE "High" Current	$I_{CEH}$	$V_{CE}=V_{IN}$	-	-	0.1	$\mu A$	2
CE "Low" Current	$I_{CEL}$	$V_{CE}=V_{SS}$	-0.2	-0.05	0	$\mu A$	2

NOTE:

\*1:  $V_{OUT(T)}$ =Specified output voltage .

\*2:  $V_{OUT(E)}$ =Effective output voltage (i.e. the output voltage when " $V_{OUT(T)}+1.0V$ " is provided at the  $V_{IN}$  pin while maintaining a certain  $I_{OUT}$  value).

\*3:  $V_{dif} = \{V_{IN1}^{(*5)} - V_{OUT1}^{(*4)}\}$

\*4:  $V_{OUT1}$ = A voltage equal to 98% of the output voltage whenever an amply stabilized  $I_{OUT}$   $\{V_{OUT(T)}+1.0V\}$  is input.

\*5:  $V_{IN1}$ = The input voltage when  $V_{OUT1}$  appears as input voltage is gradually decreased.

## ■ TYPICAL APPLICATION CIRCUIT

### ● Standard Circuit

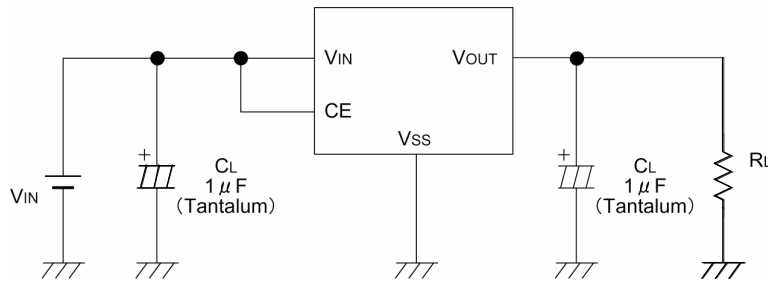

## ■ TEST CIRCUITS

### Circuit 1

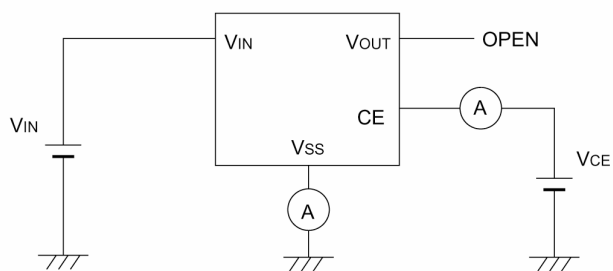
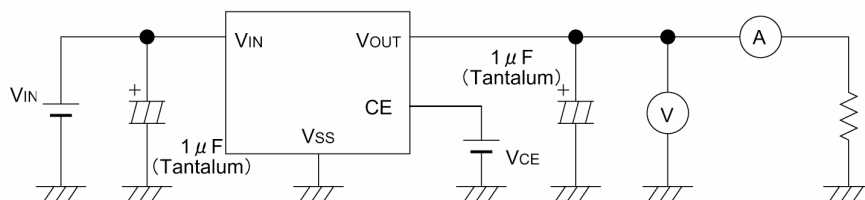

## TYPICAL PERFORMANCE CHARACTERISTICS

### (1) Output Voltage vs. Output Current

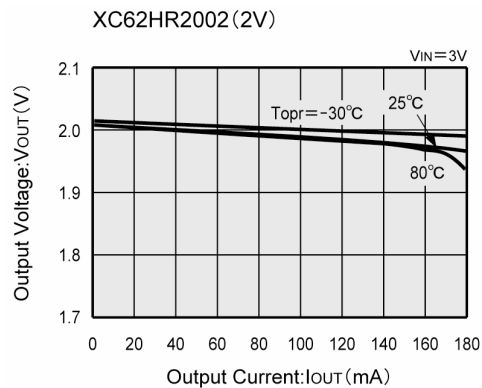
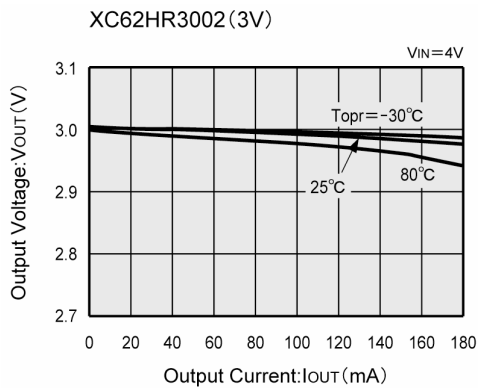
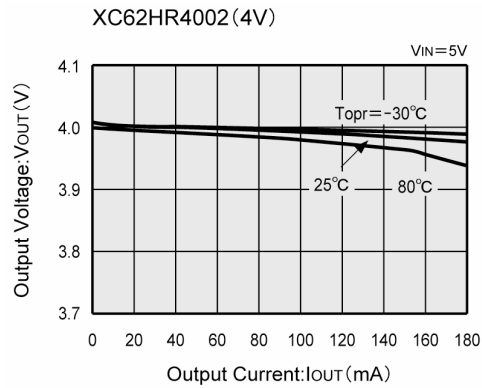
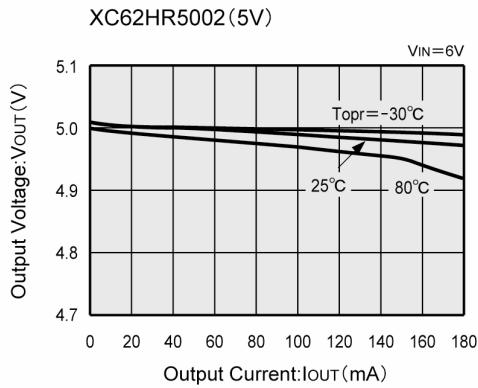

### (2) Output Voltage vs. Input Voltage

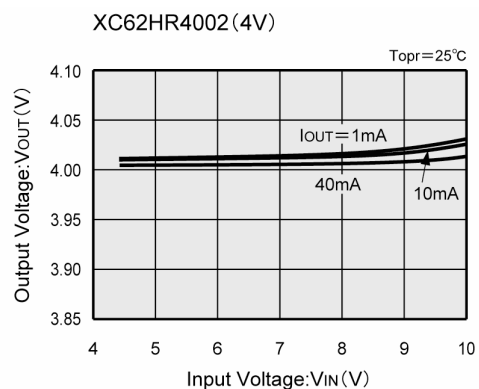
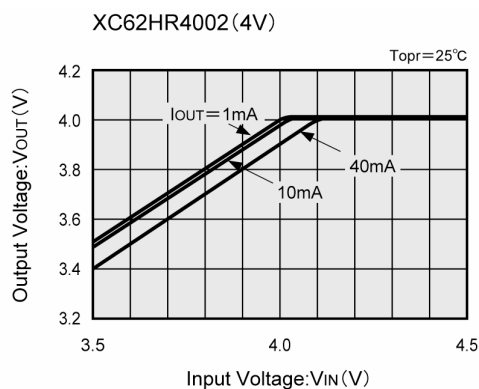
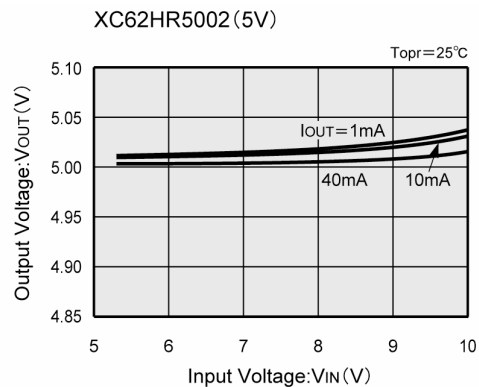
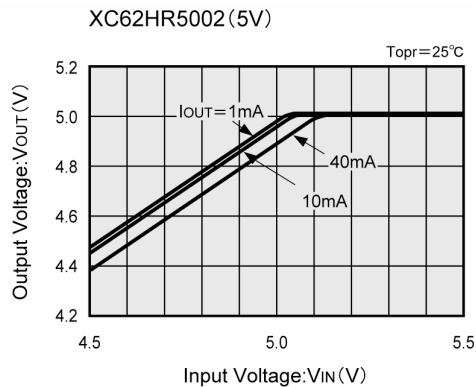



## ■ TYPICAL PERFORMANCE CHARACTERISTICS (Continued)

### (2) Output Voltage vs. Input Voltage (Continued)

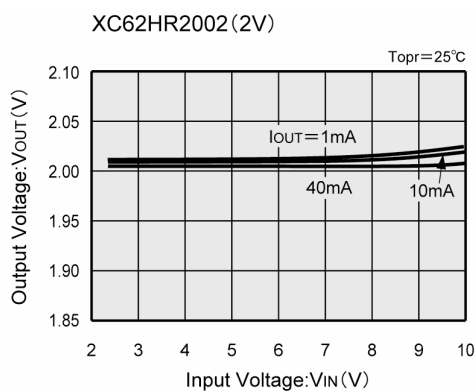
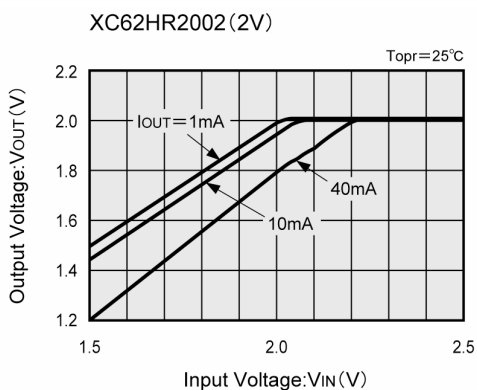
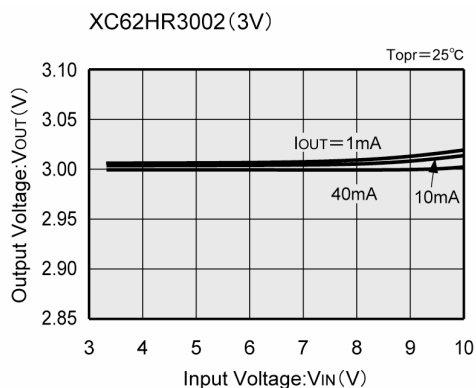
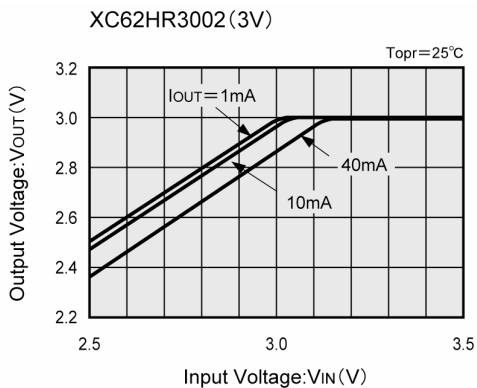

### (3) Dropout Voltage vs. Output Current

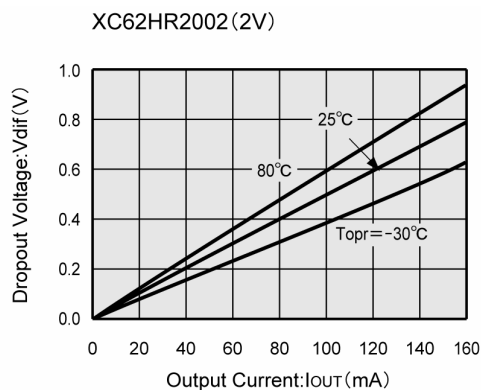
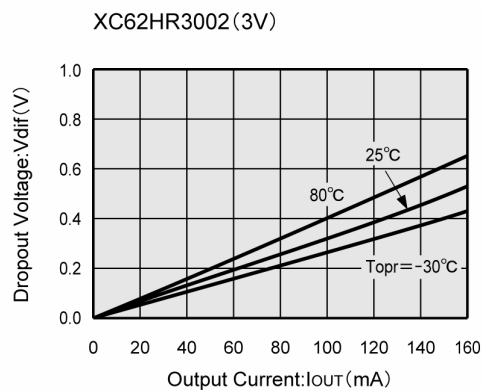
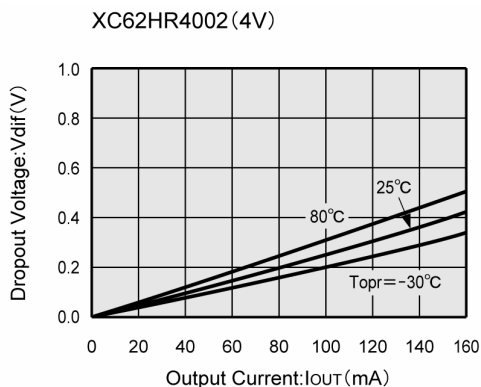
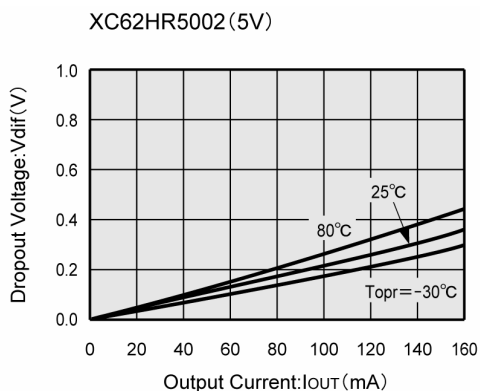

## TYPICAL PERFORMANCE CHARACTERISTICS (Continued)

### (4) CE Pin Threshold Voltage vs. Input Voltage

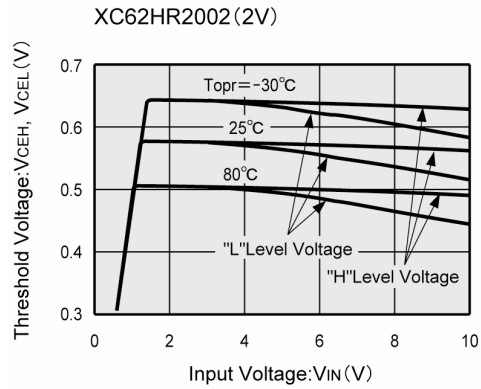
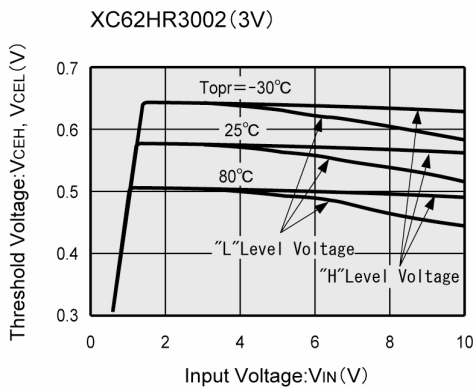
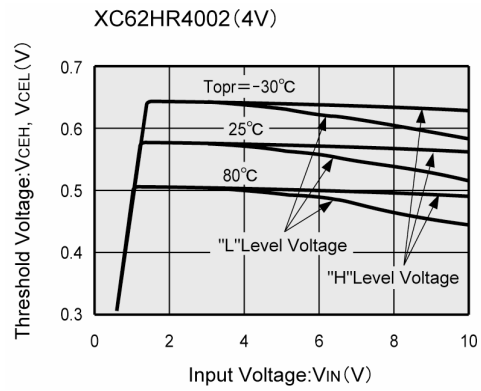
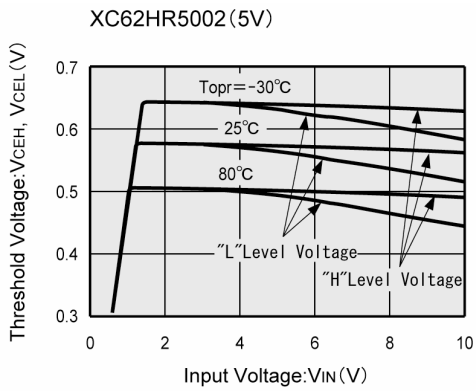

### (5) Supply Current vs. Input Voltage

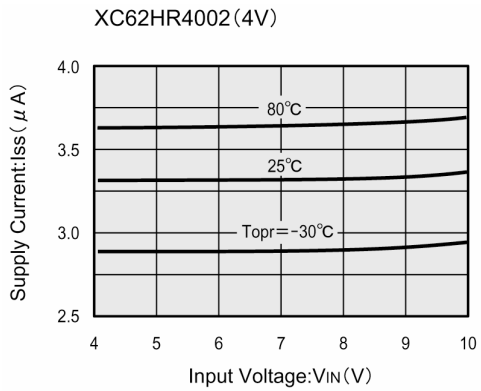
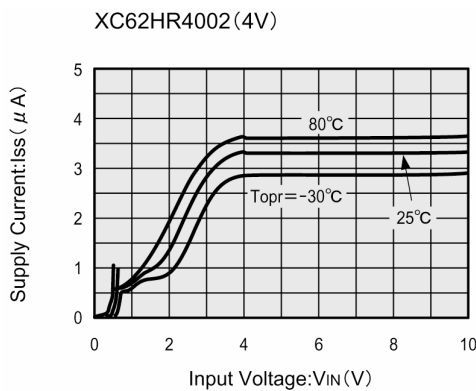
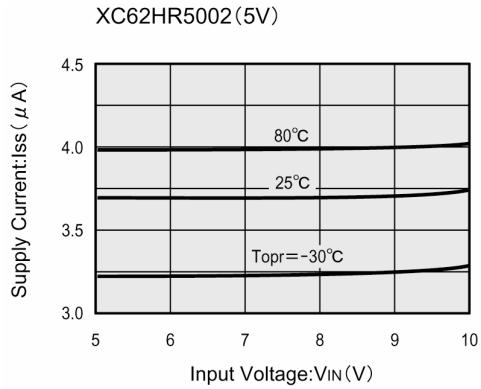
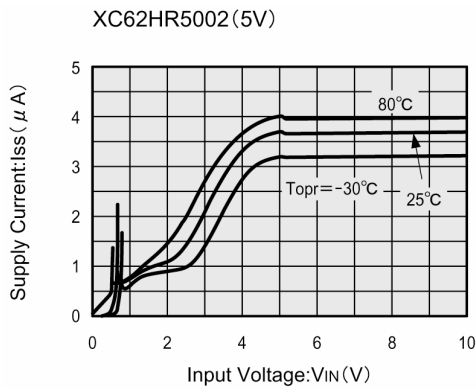

## ■ TYPICAL PERFORMANCE CHARACTERISTICS (Continued)

### (5) Supply Current vs. Input Voltage (Continued)

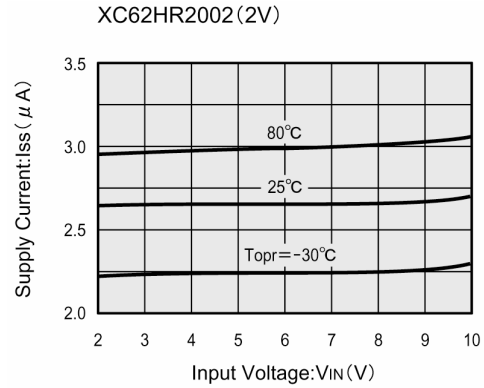
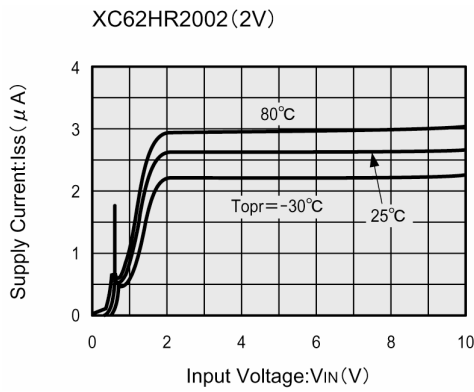
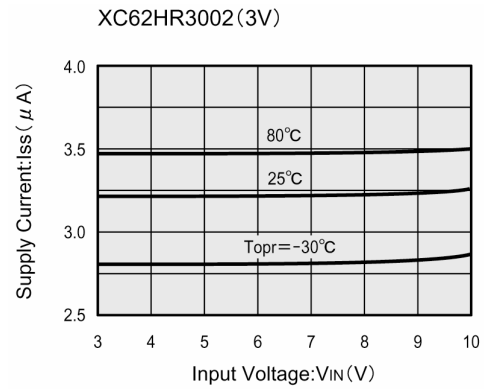
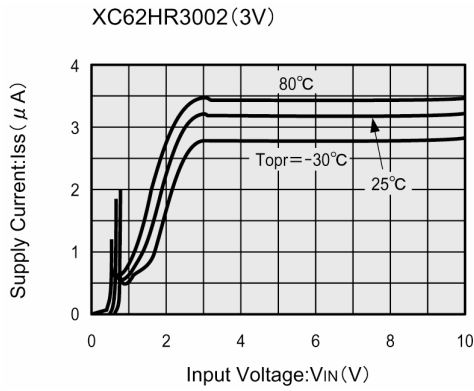

### (6) Output Voltage vs. Ambient Temperature

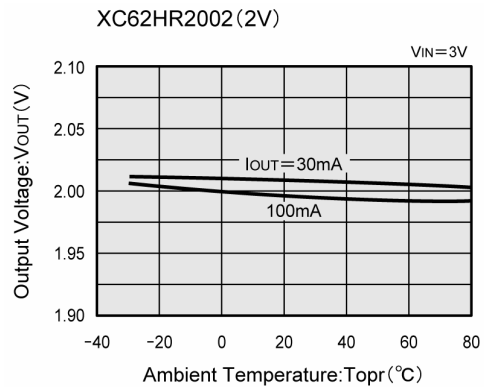
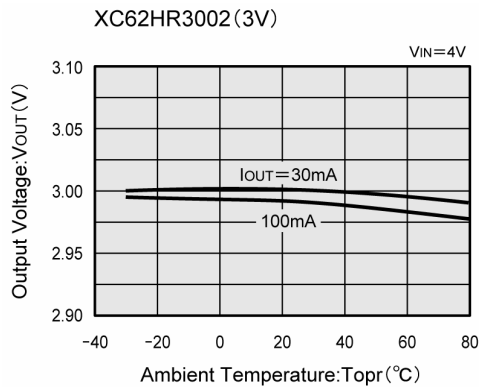
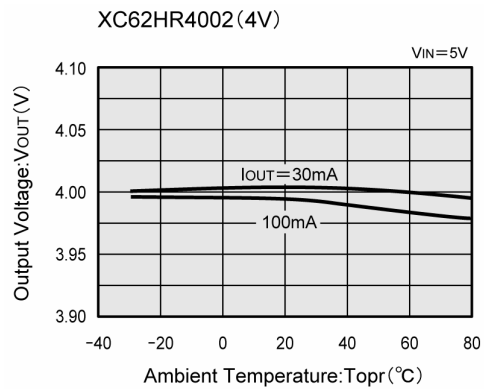
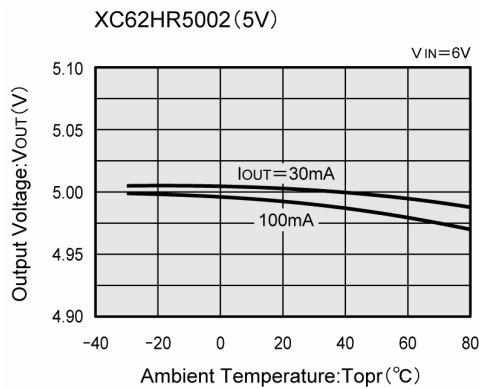

## TYPICAL PERFORMANCE CHARACTERISTICS (Continued)

### (7) Supply Current vs. Ambient Temperature

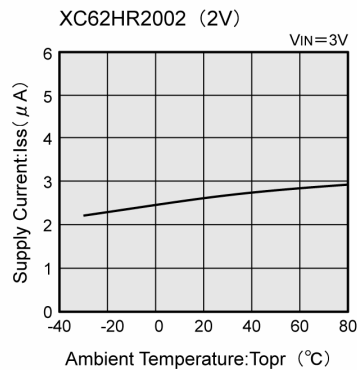
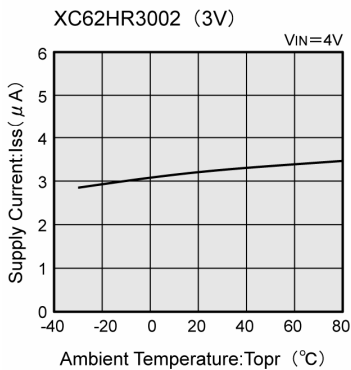
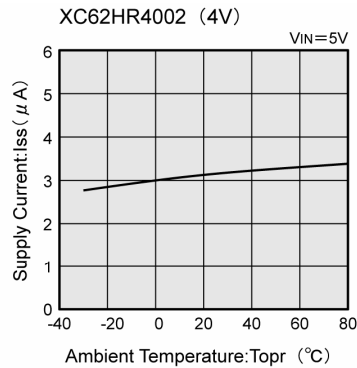
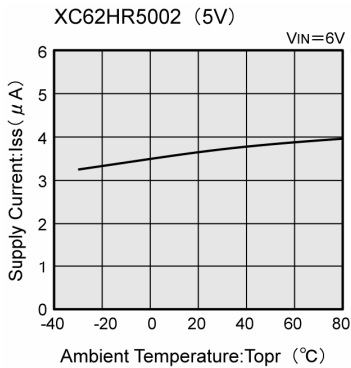

### (8) Input Transient Response 1

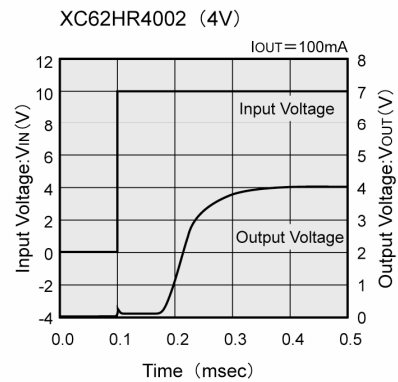
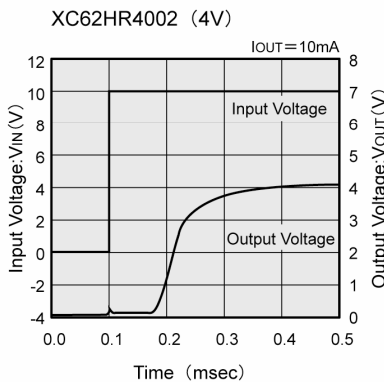
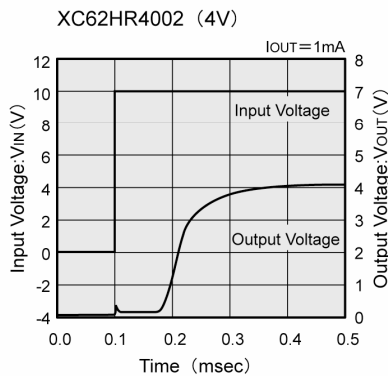
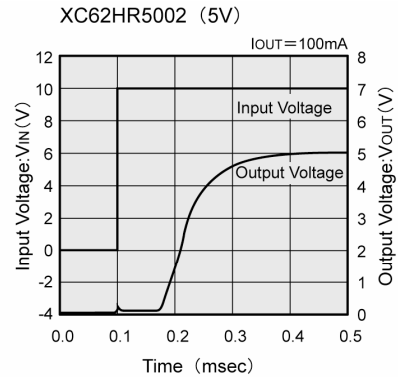
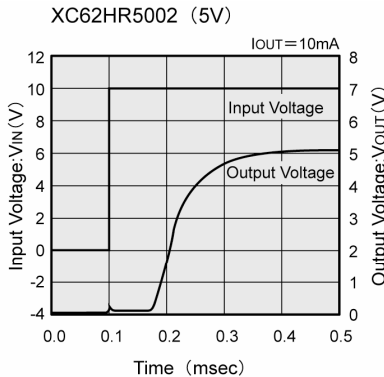
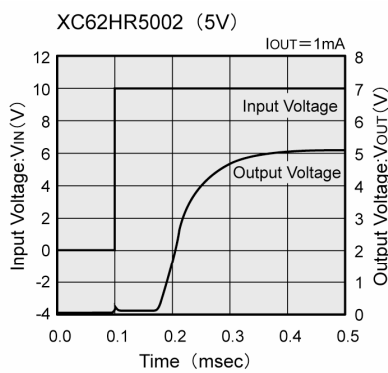

## ■ TYPICAL PERFORMANCE CHARACTERISTICS (Continued)

### (8) Input Transient Response 1 (Continued)

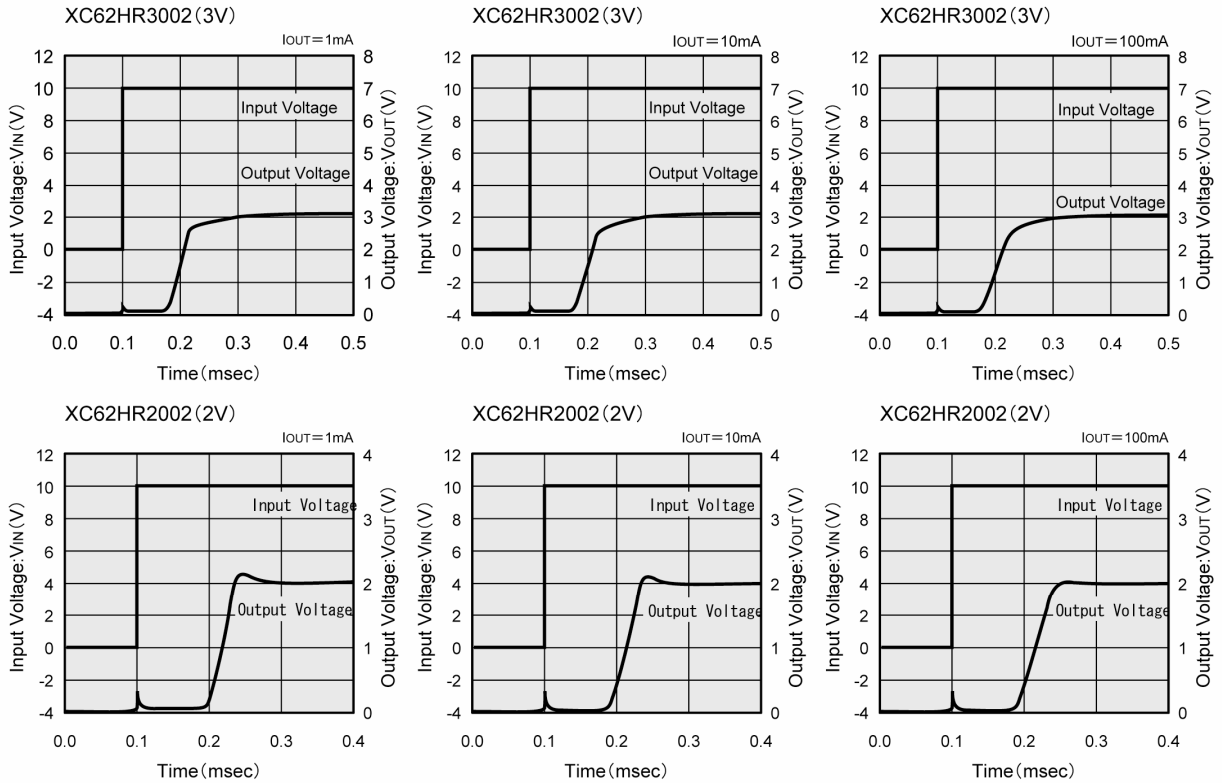

### (9) Input Transient Response 2

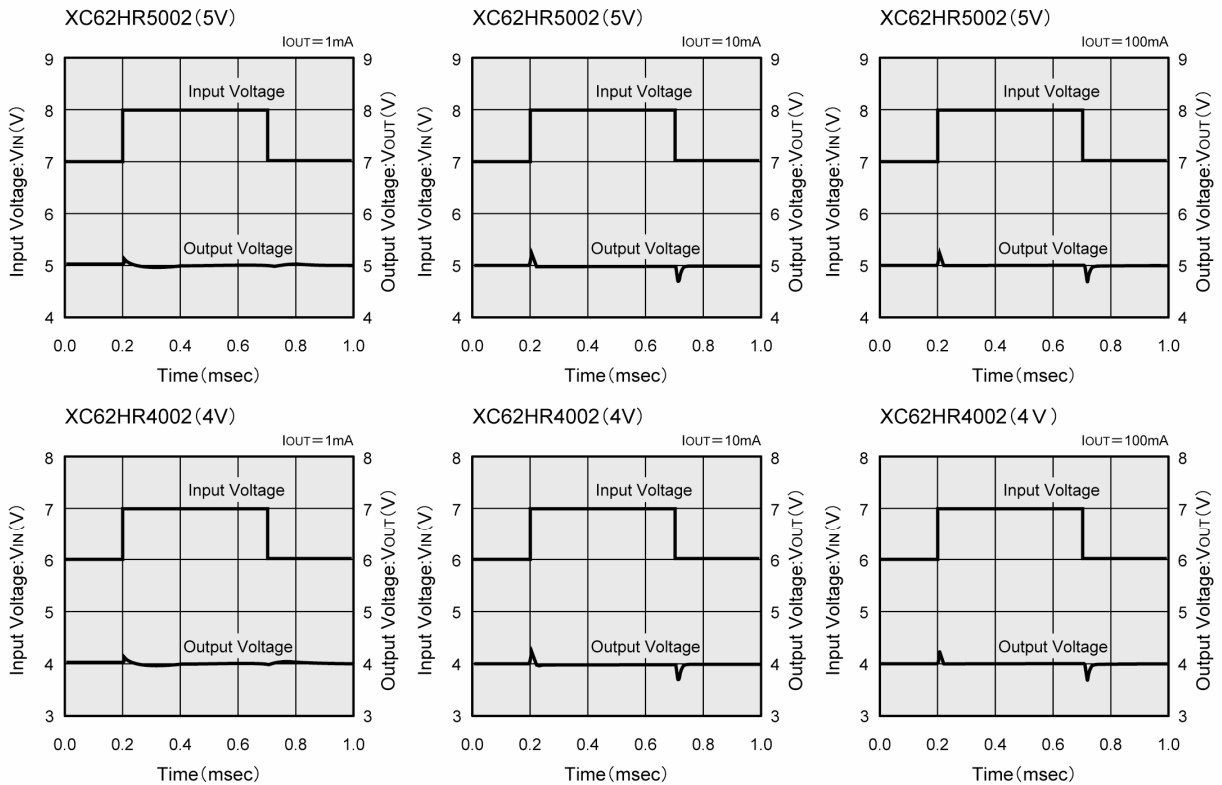

## TYPICAL PERFORMANCE CHARACTERISTICS (Continued)

### (9) Input Transient Response 2 (Continued)

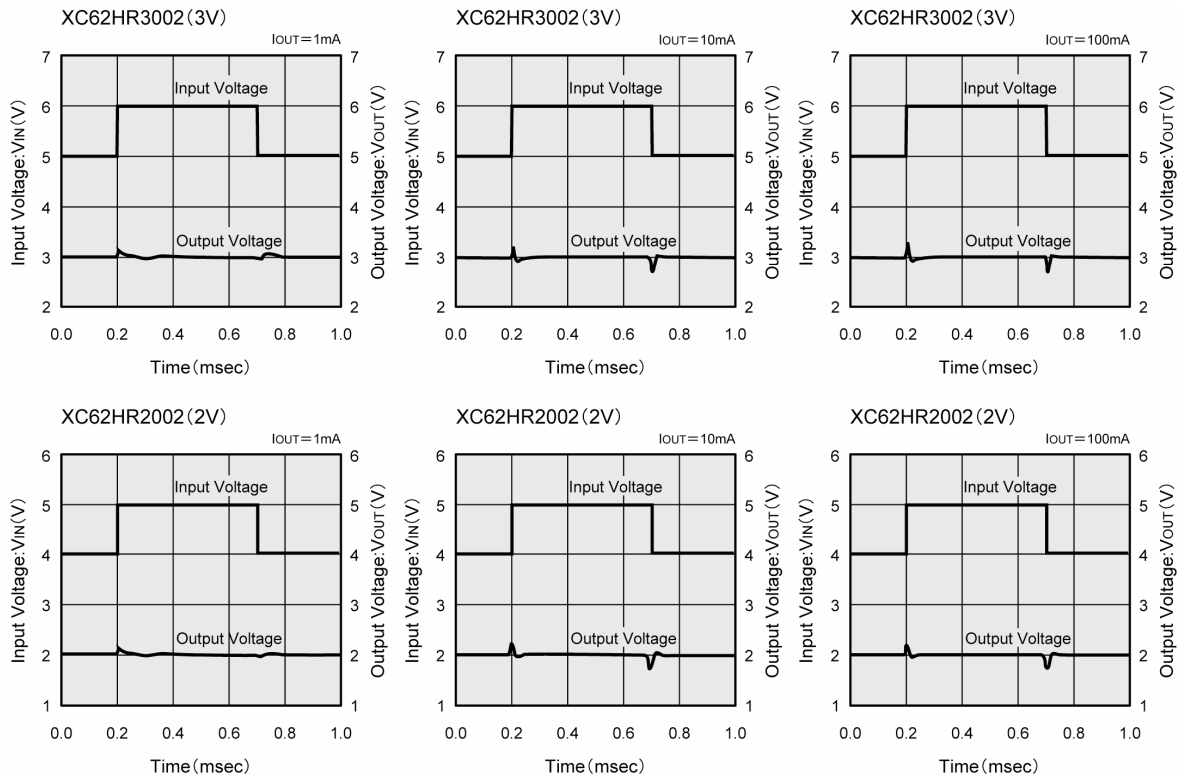

### (10) Load Transient Response

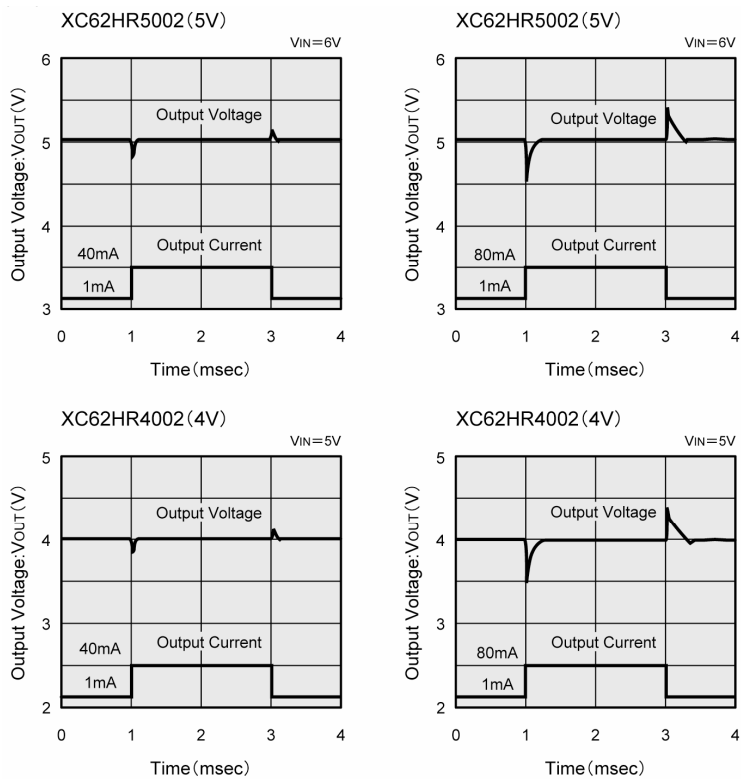

## ■ TYPICAL PERFORMANCE CHARACTERISTICS (Continued)

### (10) Load Transient Response (Continued)

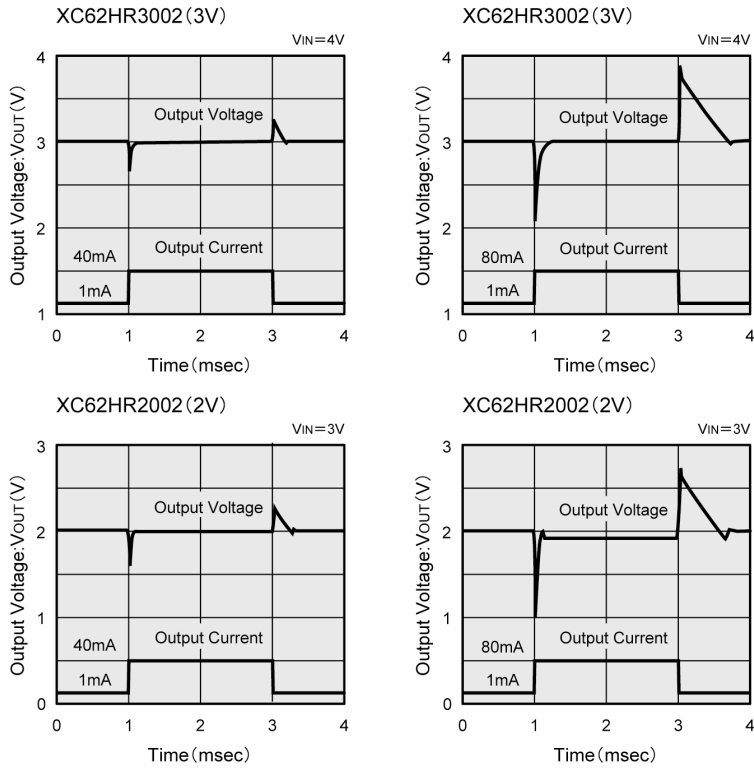

### (11) CE Pin Transient Response

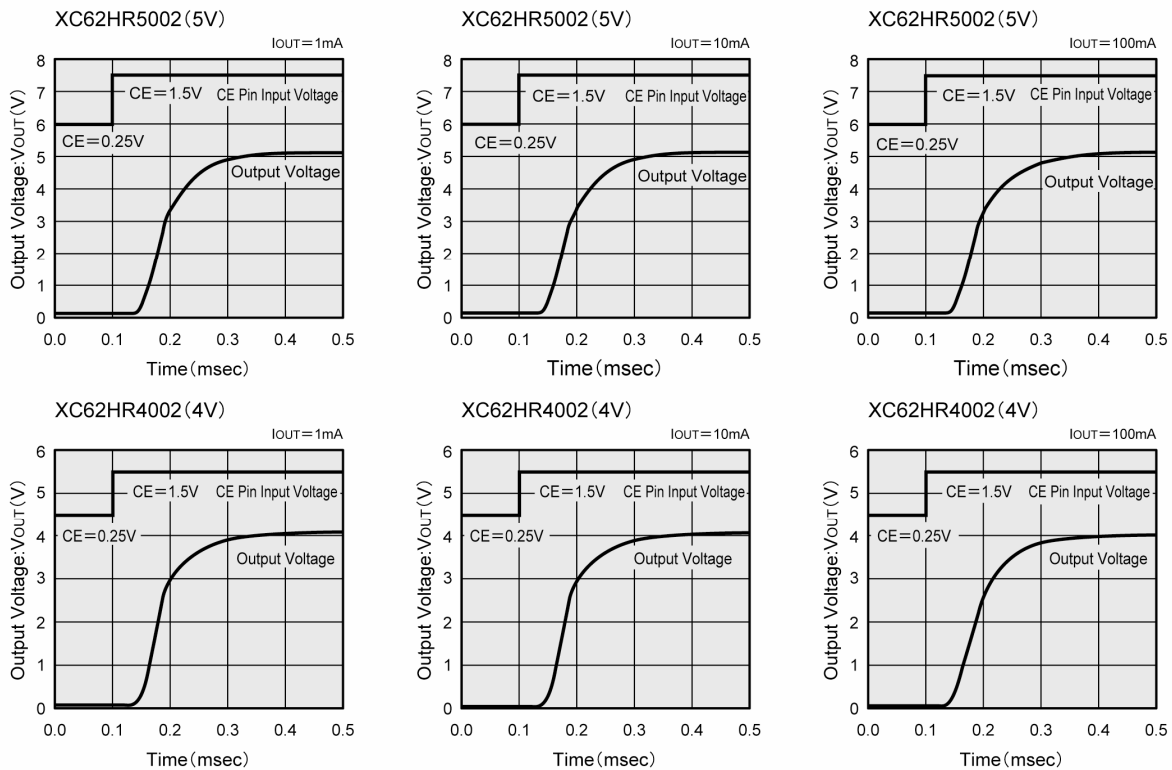

## TYPICAL PERFORMANCE CHARACTERISTICS (Continued)

### (11) CE Pin Transient Response (Continued)

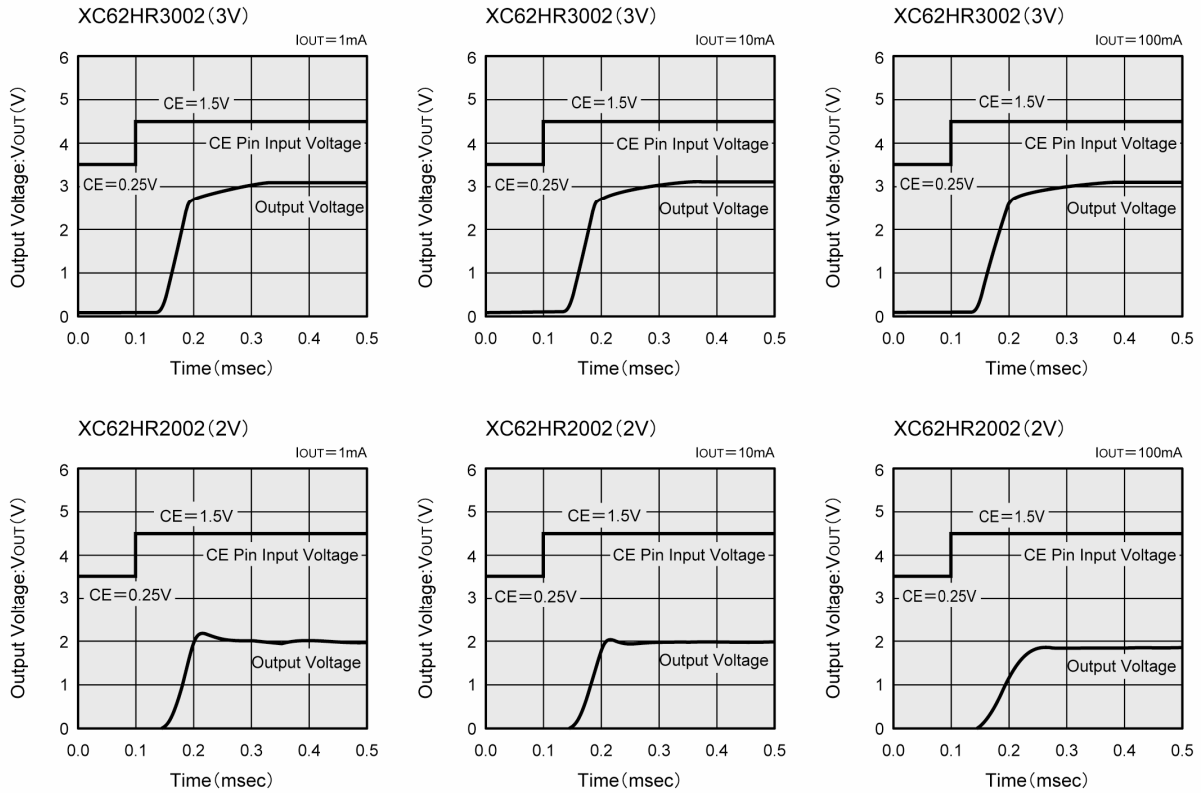

### (12) Ripple Rejection Rate

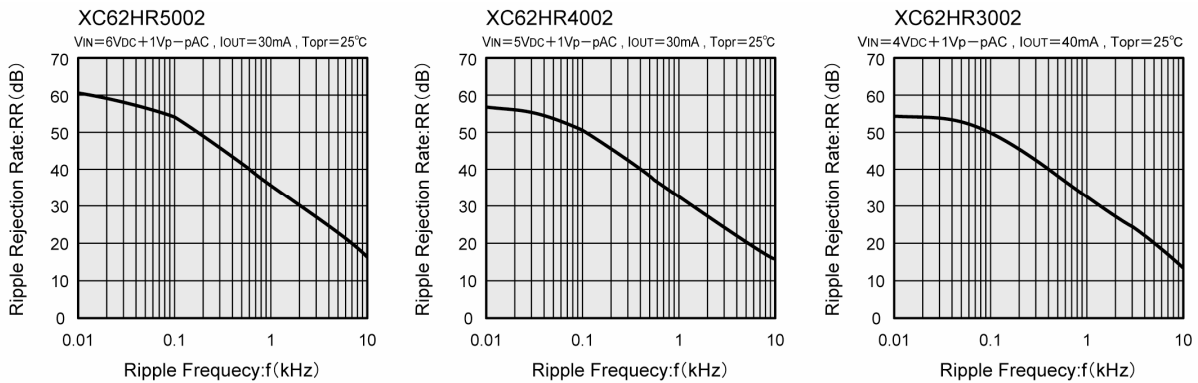



**PACKAGING INFORMATION**

● SOT-25

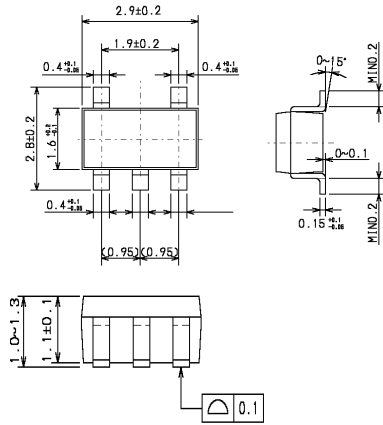

● SOT-89-5

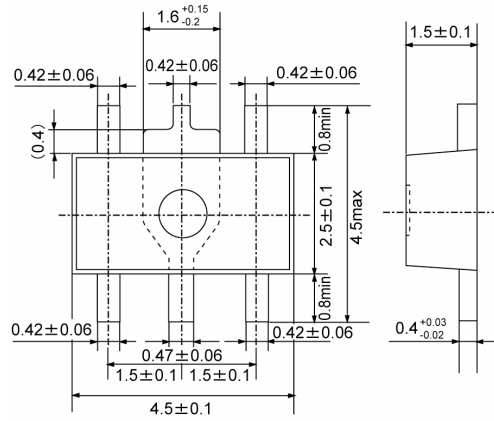

● USP-6B

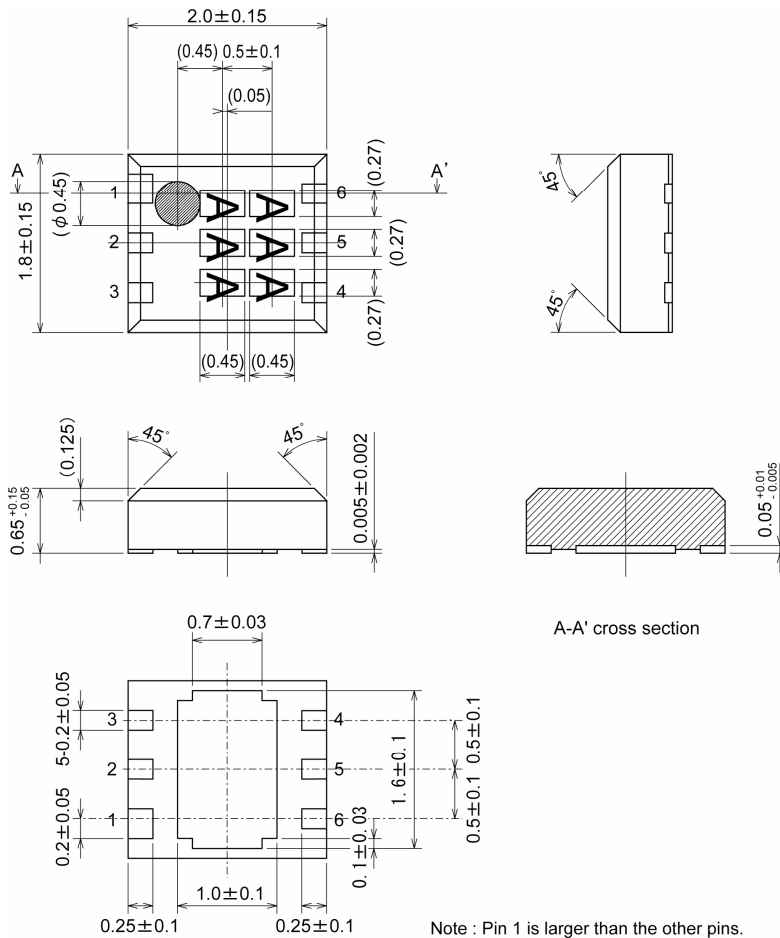

## REFERENCE PATTERN LAYOUT DIMENSIONS

### ● USP-6B

Note: Recommended metal mask design

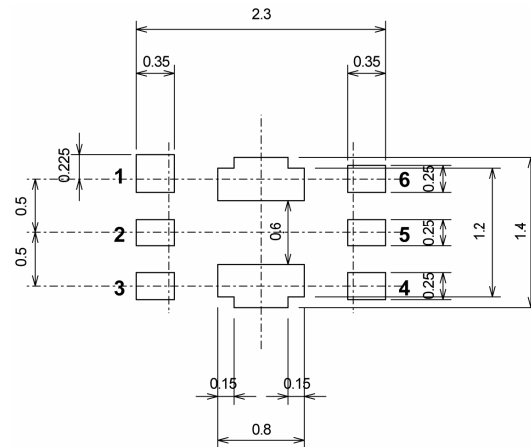
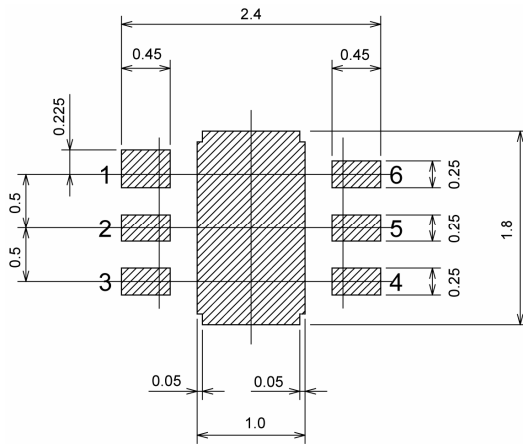

## MARKING RULE

### ● SOT-25, SOT-89-5

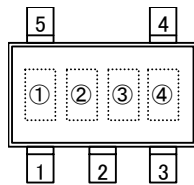

SOT-25  
(TOP VIEW)

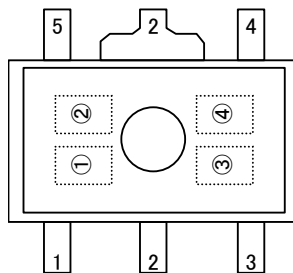

SOT-89-5  
(TOP VIEW)

① Represents integer of the output voltage

MARK	VOLTAGE (V)	MARK	VOLTAGE (V)
0	0.x	0	0.x
1	1.x	1	1.x
2	2.x	2	2.x
3	3.x	3	3.x
4	4.x	4	4.x
5	5.x	5	5.x
6	6.x	6	6.x
7	7.x	7	7.x
8	8.x	8	8.x
9	9.x	9	9.x

② Represents decimal number of the output voltage

MARK	VOLTAGE (V)	MARK	VOLTAGE (V)
0	x.0	0	x.0
1	x.1	1	x.1
2	x.2	2	x.2
3	x.3	3	x.3
4	x.4	4	x.4
5	x.5	5	x.5
6	x.6	6	x.6
7	x.7	7	x.7
8	x.8	8	x.8
9	x.9	9	x.9

③ Based on internal standards

④ Represents assembly lot number.

0 to 9, A to Z repeated (G, I, J, O, Q, W excepted)

1. The products and product specifications contained herein are subject to change without notice to improve performance characteristics. Consult us, or our representatives before use, to confirm that the information in this catalog is up to date.
2. We assume no responsibility for any infringement of patents, patent rights, or other rights arising from the use of any information and circuitry in this catalog.
3. Please ensure suitable shipping controls (including fail-safe designs and aging protection) are in force for equipment employing products listed in this catalog.
4. The products in this catalog are not developed, designed, or approved for use with such equipment whose failure or malfunction can be reasonably expected to directly endanger the life of, or cause significant injury to, the user.  
(e.g. Atomic energy; aerospace; transport; combustion and associated safety equipment thereof.)
5. Please use the products listed in this catalog within the specified ranges.  
Should you wish to use the products under conditions exceeding the specifications, please consult us or our representatives.
6. We assume no responsibility for damage or loss due to abnormal use.
7. All rights reserved. No part of this catalog may be copied or reproduced without the prior permission of Torex Semiconductor Ltd.

**TOREX SEMICONDUCTOR LTD.**