



# RF Power Field Effect Transistor

## N-Channel Enhancement-Mode Lateral MOSFET

Designed for CDMA base station applications with frequencies from 2600 to 2700 MHz. Suitable for WiMAX, WiBro and multicarrier amplifier applications. To be used in Class AB and Class C for WLL applications.

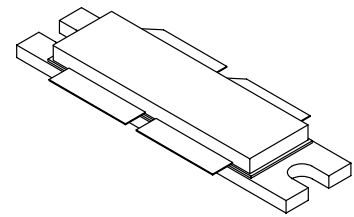
- Typical Single-Carrier N-CDMA Performance:  $V_{DD} = 28$  Volts,  $I_{DQ} = 1800$  mA,  $P_{out} = 35$  Watts Avg., Full Frequency Band, IS-95 CDMA (Pilot, Sync, Paging, Traffic Codes 8 Through 13) Channel Bandwidth = 1.2288 MHz. PAR = 9.8 dB @ 0.01% Probability on CCDF.
  - Power Gain — 14.6 dB
  - Drain Efficiency — 22.6%
  - ACPR @ 885 kHz Offset — -47.8 dBc in 30 kHz Bandwidth
- Capable of Handling 10:1 VSWR, @ 28 Vdc, 2650 MHz, 160 Watts CW Output Power

### Features

- Characterized with Series Equivalent Large-Signal Impedance Parameters
- Internally Matched for Ease of Use
- Qualified Up to a Maximum of 32  $V_{DD}$  Operation
- Integrated ESD Protection
- Lower Thermal Resistance Package
- Designed for Lower Memory Effects and Wide Instantaneous Bandwidth Applications
- Low Gold Plating Thickness on Leads, 40 $\mu$ m Nominal.
- RoHS Compliant
- In Tape and Reel. R6 Suffix = 150 Units per 56 mm, 13 inch Reel.

**MRF6P27160HR6**

**2600-2700 MHz, 35 W AVG., 28 V  
 SINGLE N-CDMA  
 LATERAL N-CHANNEL  
 RF POWER MOSFET**



**CASE 375D-05, STYLE 1  
 NI-1230**

**Table 1. Maximum Ratings**

Rating	Symbol	Value	Unit
Drain-Source Voltage	$V_{DSS}$	-0.5, +68	Vdc
Gate-Source Voltage	$V_{GS}$	-0.5, +12	Vdc
Total Device Dissipation @ $T_C = 25^\circ\text{C}$ Derate above 25 $^\circ\text{C}$	$P_D$	603 3.45	W W/ $^\circ\text{C}$
Storage Temperature Range	$T_{stg}$	- 65 to +150	$^\circ\text{C}$
Case Operating Temperature	$T_C$	150	$^\circ\text{C}$
Operating Junction Temperature	$T_J$	200	$^\circ\text{C}$

**Table 2. Thermal Characteristics**

Characteristic	Symbol	Value (1,2)	Unit
Thermal Resistance, Junction to Case Case Temperature 79 $^\circ\text{C}$ , 160 W CW Case Temperature 71 $^\circ\text{C}$ , 35 W CW	$R_{\theta JC}$	0.29 0.31	$^\circ\text{C}/\text{W}$

1. MTF calculator available at <http://www.freescale.com/rf>. Select Tools/Software/Application Software/Calculators to access the MTF calculators by product.
2. Refer to AN1955, *Thermal Measurement Methodology of RF Power Amplifiers*. Go to <http://www.freescale.com/rf>. Select Documentation/Application Notes - AN1955.

**Table 3. ESD Protection Characteristics**

Test Methodology	Class
Human Body Model (per JESD22-A114)	1C (Minimum)
Machine Model (per EIA/JESD22-A115)	A (Minimum)
Charge Device Model (per JESD22-C101)	III (Minimum)

**Table 4. Electrical Characteristics** ( $T_C = 25^\circ\text{C}$  unless otherwise noted)

Characteristic	Symbol	Min	Typ	Max	Unit
----------------	--------	-----	-----	-----	------

**Off Characteristics** <sup>(1)</sup>

Zero Gate Voltage Drain Leakage Current ( $V_{DS} = 68\text{ Vdc}$ , $V_{GS} = 0\text{ Vdc}$ )	$I_{DSS}$	—	—	10	$\mu\text{Adc}$
Zero Gate Voltage Drain Leakage Current ( $V_{DS} = 28\text{ Vdc}$ , $V_{GS} = 0\text{ Vdc}$ )	$I_{DSS}$	—	—	1	$\mu\text{Adc}$
Gate-Source Leakage Current ( $V_{GS} = 5\text{ Vdc}$ , $V_{DS} = 0\text{ Vdc}$ )	$I_{GSS}$	—	—	1	$\mu\text{Adc}$

**On Characteristics**

Gate Threshold Voltage <sup>(1)</sup> ( $V_{DS} = 10\text{ Vdc}$ , $I_D = 250\ \mu\text{Adc}$ )	$V_{GS(th)}$	1	2	3	Vdc
Gate Quiescent Voltage <sup>(3)</sup> ( $V_{DS} = 28\text{ Vdc}$ , $I_D = 1800\ \text{mAdc}$ )	$V_{GS(Q)}$	2	2.8	4	Vdc
Drain-Source On-Voltage <sup>(1)</sup> ( $V_{GS} = 10\text{ Vdc}$ , $I_D = 2.2\ \text{Adc}$ )	$V_{DS(on)}$	—	0.21	0.3	Vdc
Forward Transconductance <sup>(1)</sup> ( $V_{DS} = 10\text{ Vdc}$ , $I_D = 2\ \text{Adc}$ )	$g_{fs}$	—	5.3	—	S

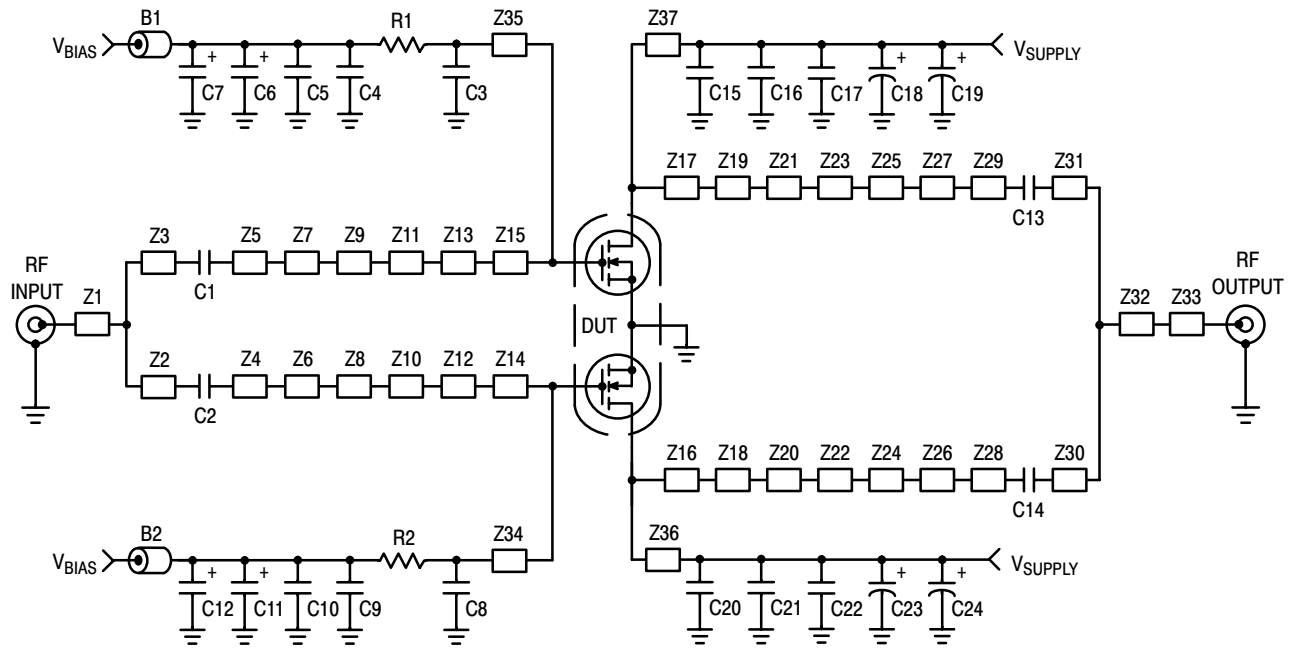
**Dynamic Characteristics** <sup>(1,2)</sup>

Reverse Transfer Capacitance ( $V_{DS} = 28\text{ Vdc} \pm 30\ \text{mV(rms)ac}$ @ 1 MHz, $V_{GS} = 0\text{ Vdc}$ )	$C_{rss}$	—	2.8	—	pF
--	-----------	---	-----	---	----

**Functional Tests** <sup>(3)</sup> (In Freescale Test Fixture, 50 ohm system)  $V_{DD} = 28\text{ Vdc}$ ,  $I_{DQ} = 1800\ \text{mA}$ ,  $P_{out} = 35\ \text{W Avg. N-CDMA}$ ,  $f = 2630$  and  $2660\ \text{MHz}$ , Single-Carrier N-CDMA, 1.2288 MHz Channel Bandwidth Carrier. ACPR measured in 30 kHz Channel Bandwidth @  $\pm 885\ \text{kHz}$  Offset. PAR = 9.8 dB @ 0.01% Probability on CCDF

Power Gain	$G_{ps}$	13	14.6	16	dB
Drain Efficiency	$\eta_D$	20	22.6	—	%
Adjacent Channel Power Ratio	ACPR	—	-47.8	-45	dBc
Input Return Loss	IRL	—	-13	-9	dB

1. Each side of device measured separately.
2. Part internally matched both on input and output.
3. Measurement made with device in push-pull configuration.

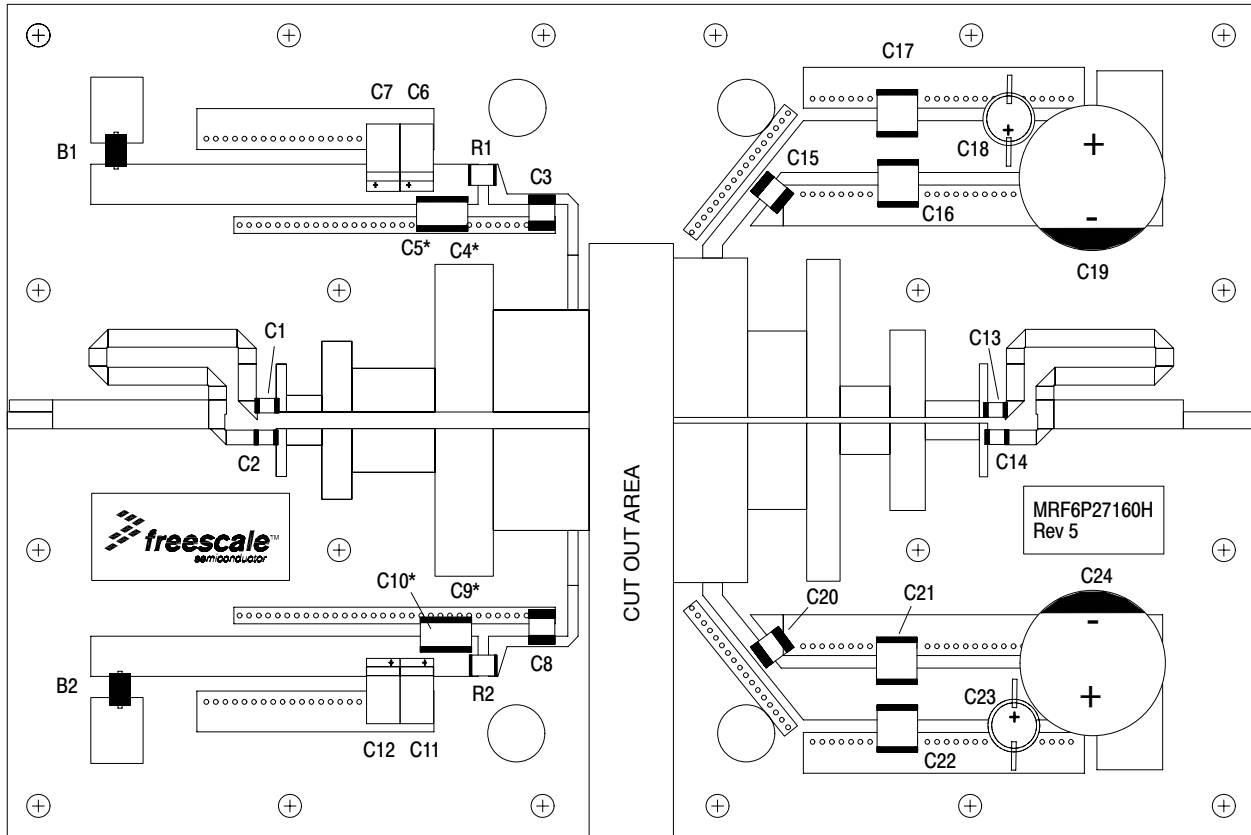


Z1	1.011" x 0.139" Microstrip	Z20, Z21	0.160" x 0.760" Microstrip
Z2, Z31	0.150" x 0.070" Microstrip	Z22, Z23	0.240" x 0.150" Microstrip
Z3, Z30	1.500" x 0.086" Microstrip	Z24, Z25	0.170" x 0.420" Microstrip
Z4, Z5	0.050" x 0.230" Microstrip	Z26, Z27	0.260" x 0.080" Microstrip
Z6, Z7	0.170" x 0.080" Microstrip	Z28, Z29	0.040" x 0.258" Microstrip
Z8, Z9	0.144" x 0.340" Microstrip	Z32	0.622" x 0.139" Microstrip
Z10, Z11	0.400" x 0.210" Microstrip	Z33	0.346" x 0.081" Microstrip
Z12, Z13	0.280" x 0.710" Microstrip	Z34, Z35	0.801" x 0.050" Microstrip
Z14, Z15	0.461" x 0.490" Microstrip	Z36, Z37	0.460" x 0.095" Microstrip
Z16, Z17	0.357" x 0.766" Microstrip	PCB	Arlon GX-0300-5022, 0.030", $\epsilon_r = 2.5$
Z18, Z19	0.284" x 0.415" Microstrip		

**Figure 1. MRF6P27160HR6 Test Circuit Schematic**

**Table 5. MRF6P27160HR6 Test Circuit Component Designations and Values**

Part	Description	Part Number	Manufacturer
B1, B2	Beads, Surface Mount	2743019447	Fair-Rite
C1, C2	5.6 pF Chip Capacitors	100B5R6CP500X	ATC
C3, C8, C15, C20	3.3 pF Chip Capacitors	100B3R3CP500X	ATC
C4, C9	0.01 $\mu$ F Chip Capacitors (1825)	C1825C103J1RAC	Kemet
C5, C10	2.2 $\mu$ F, 50 V Chip Capacitors (1825)	C1825C225J5RAC	Kemet
C6, C11	22 $\mu$ F, 25 V Tantalum Chip Capacitors	ECS-T1ED226R	Panasonic TE Series
C7, C12	47 $\mu$ F, 16 V Tantalum Chip Capacitors	T491D476K016AS	Kemet
C13, C14	4.3 pF Chip Capacitors	100B4R3CP500X	ATC
C16, C17, C21, C22	10 $\mu$ F, 50 V Chip Capacitors (2220)	GRM55DR61H106KA88B	Murata
C18, C23	47 $\mu$ F, 50 V Electrolytic Capacitors	MVK50VC47RM8X10TP	Nippon
C19, C24	330 $\mu$ F, 63 V Electrolytic Capacitors	NACZF331M63V	Nippon
R1, R2	3.3 $\Omega$ , 1/4 W Chip Resistors (1210)		



\*Stacked

Figure 2. MRF6P27160HR6 Test Circuit Component Layout

## TYPICAL CHARACTERISTICS

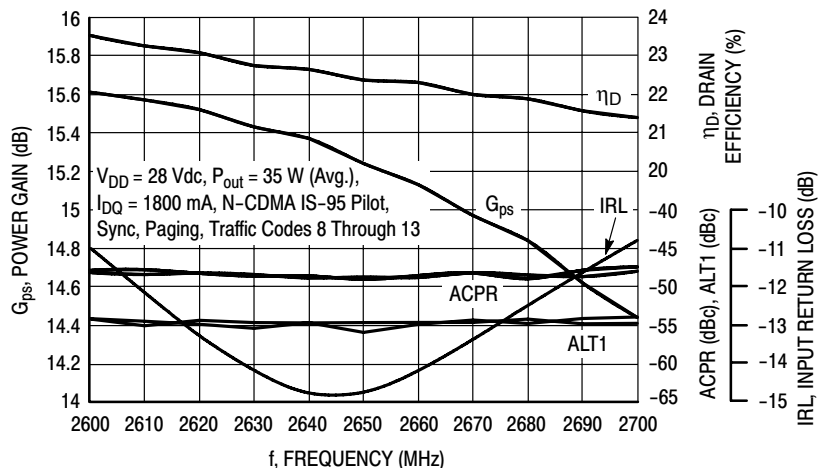


Figure 3. Single-Carrier N-CDMA Broadband Performance @  $P_{out} = 35$  Watts Avg.

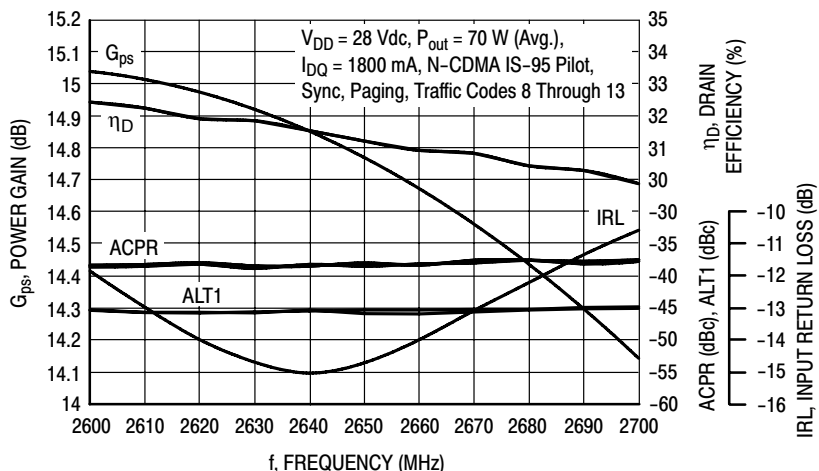


Figure 4. Single-Carrier N-CDMA Broadband Performance @  $P_{out} = 70$  Watts Avg.

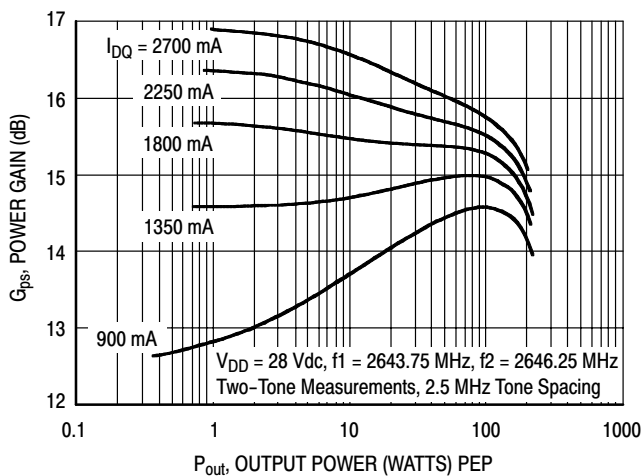


Figure 5. Two-Tone Power Gain versus Output Power

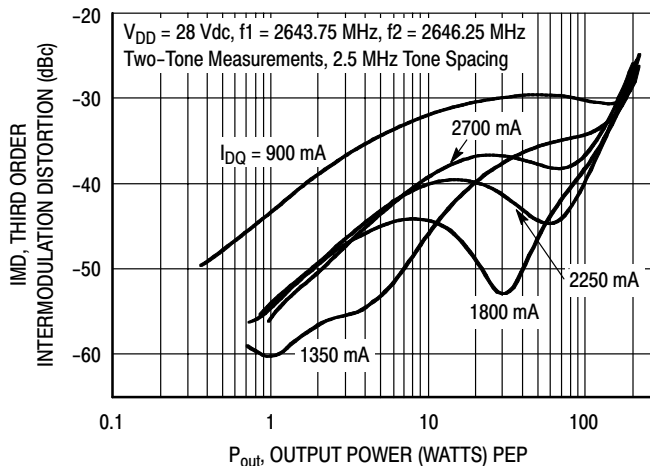
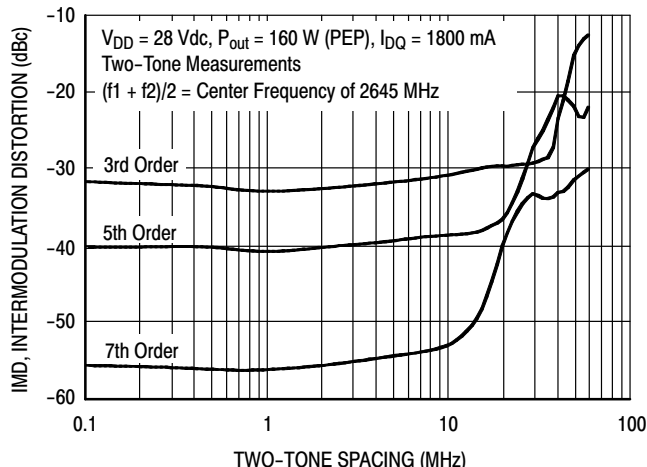
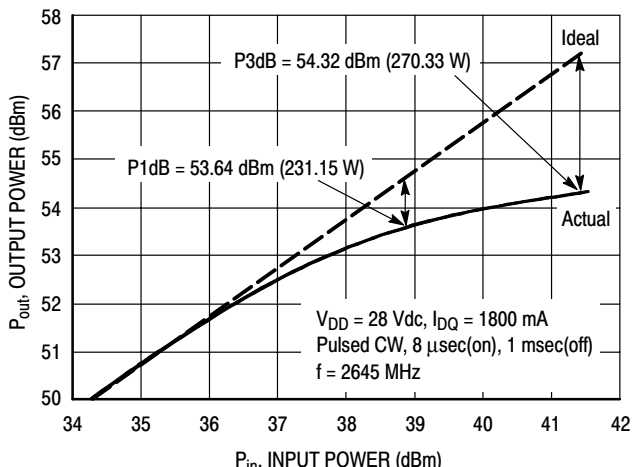


Figure 6. Third Order Intermodulation Distortion versus Output Power

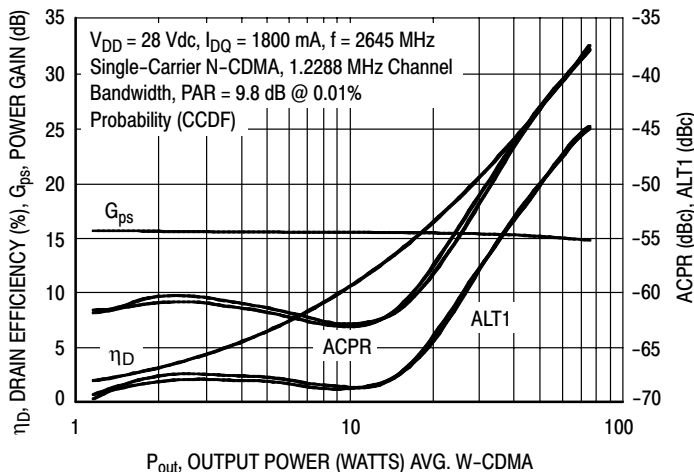
## TYPICAL CHARACTERISTICS



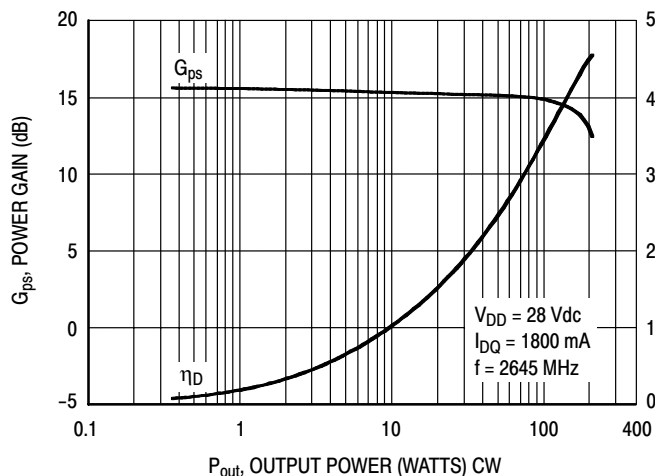
**Figure 7. Intermodulation Distortion Products versus Tone Spacing**



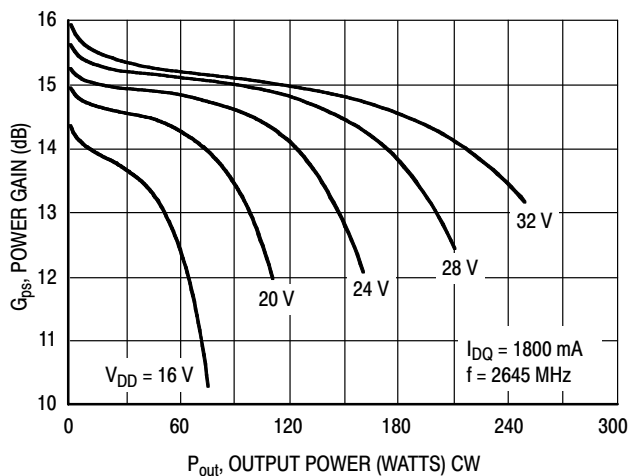
**Figure 8. Pulse CW Output Power versus Input Power**



**Figure 9. Single-Carrier N-CDMA ACPR, ALT1, Power Gain and Drain Efficiency versus Output Power**

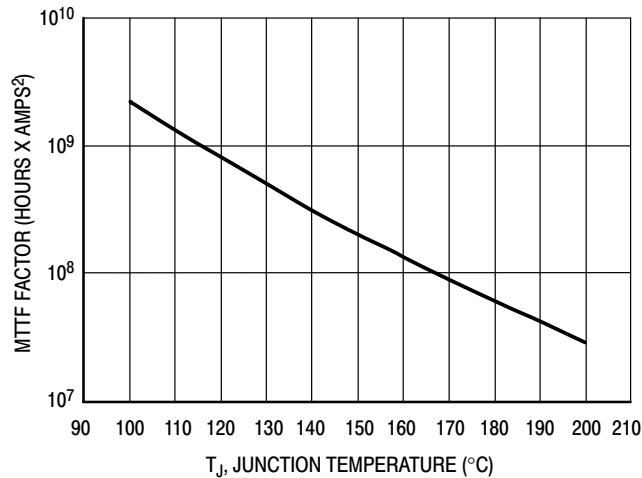


**Figure 10. Power Gain and Drain Efficiency versus CW Output Power**



**Figure 11. Power Gain versus Output Power**

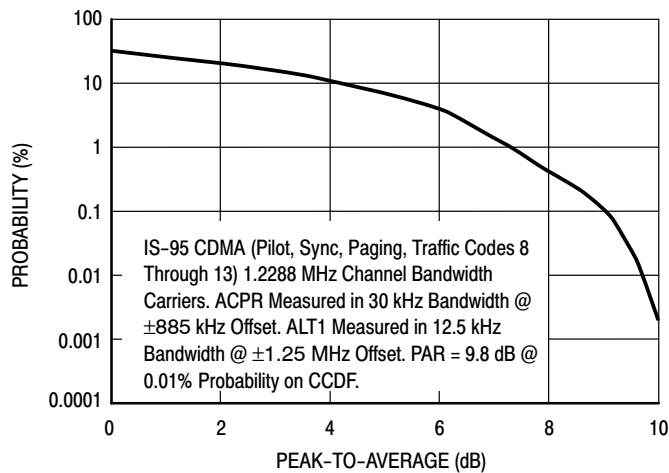
## TYPICAL CHARACTERISTICS



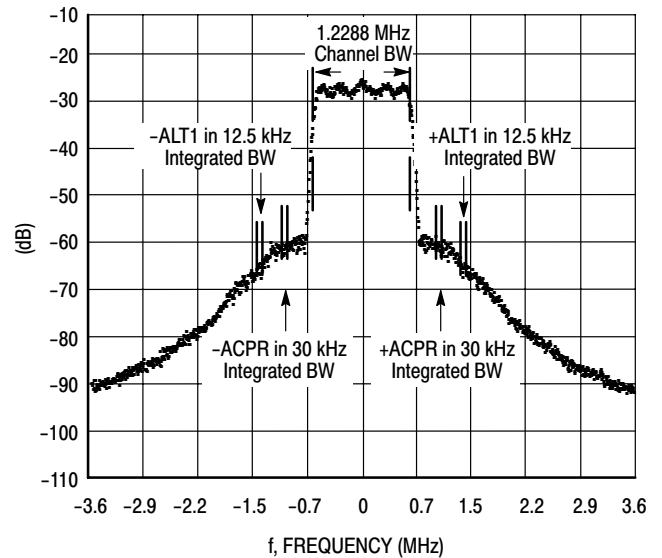
This above graph displays calculated MTTF in hours x ampere<sup>2</sup> drain current. Life tests at elevated temperatures have correlated to better than  $\pm 10\%$  of the theoretical prediction for metal failure. Divide MTTF factor by  $I_D^2$  for MTTF in a particular application.

**Figure 12. MTTF Factor versus Junction Temperature**

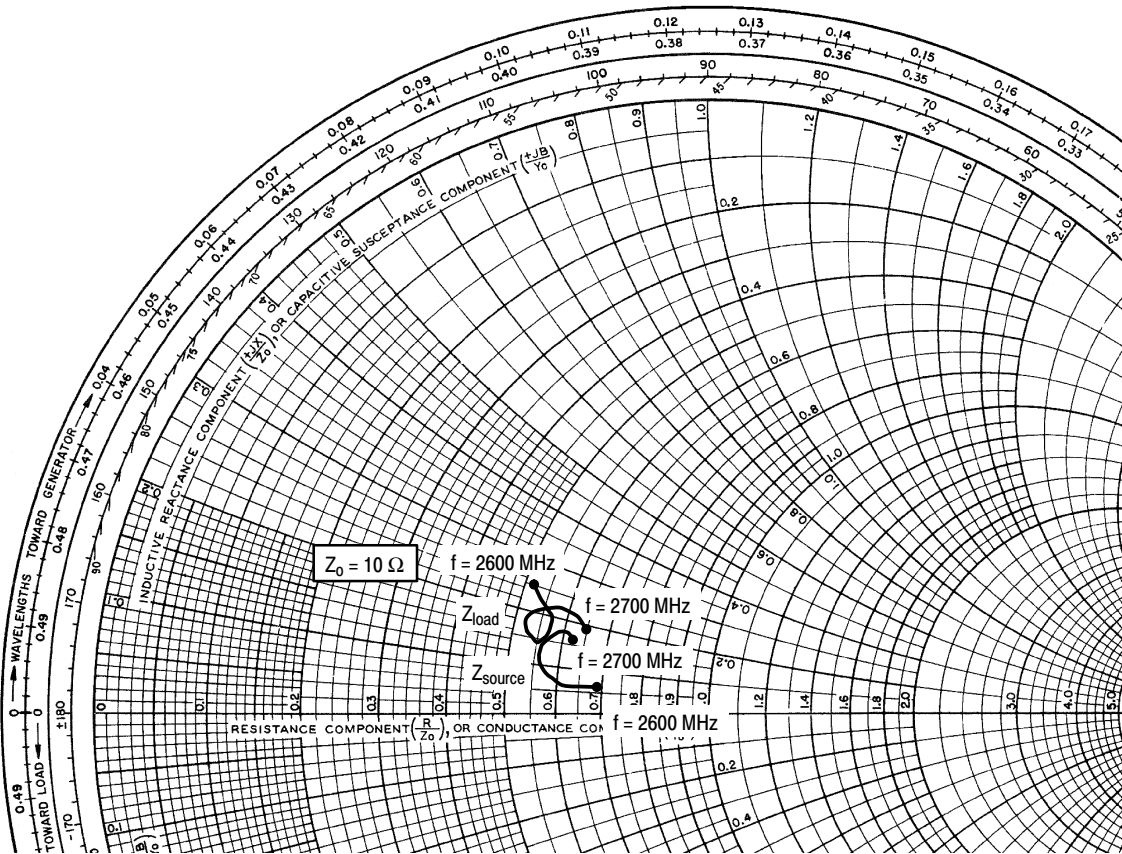
## N-CDMA TEST SIGNAL



**Figure 13. Single-Carrier CCDF N-CDMA**



**Figure 14. Single-Carrier N-CDMA Spectrum**



$V_{DD} = 28 \text{ Vdc}$ ,  $I_{DQ} = 1800 \text{ mA}$ ,  $P_{out} = 35 \text{ W Avg.}$

f MHz	$Z_{source}$ $\Omega$	$Z_{load}$ $\Omega$
2600	$6.90 + j0.61$	$5.24 + j2.46$
2610	$6.85 + j0.63$	$5.69 + j2.04$
2620	$6.76 + j0.59$	$5.71 + j1.59$
2630	$6.50 + j0.59$	$5.62 + j1.48$
2640	$6.13 + j0.56$	$5.45 + j1.42$
2645	$5.95 + j0.69$	$5.38 + j1.49$
2650	$5.81 + j0.83$	$5.31 + j1.58$
2660	$5.61 + j1.15$	$5.24 + j1.81$
2670	$5.69 + j1.48$	$5.45 + j2.09$
2680	$5.91 + j1.67$	$5.84 + j2.22$
2690	$6.12 + j1.68$	$6.22 + j2.12$
2700	$6.17 + j1.60$	$6.49 + j1.92$

$Z_{source}$  = Test circuit impedance as measured from gate to gate, balanced configuration.

$Z_{load}$  = Test circuit impedance as measured from drain to drain, balanced configuration.

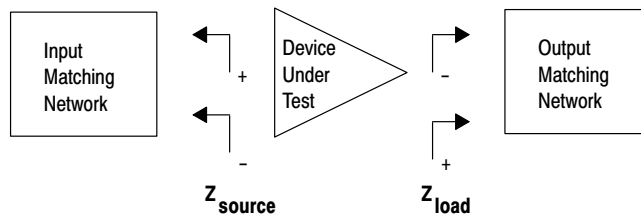


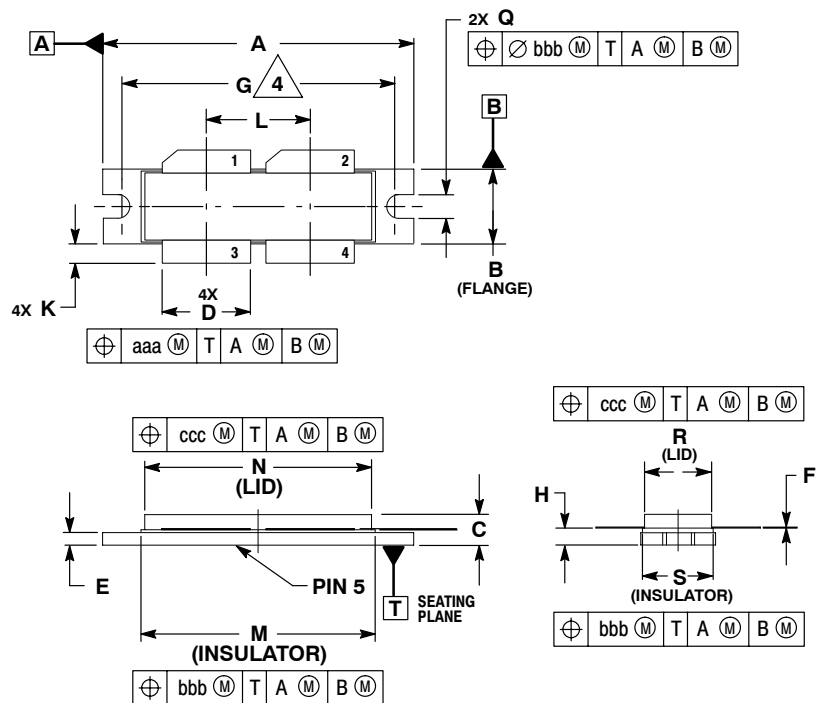
Figure 15. Series Equivalent Source and Load Impedance



# NOTES

# NOTES

## PACKAGE DIMENSIONS



### NOTES:

1. INTERPRET DIMENSIONS AND TOLERANCES PER ASME Y14.5M-1994.
2. CONTROLLING DIMENSION: INCH.
3. DIMENSION H IS MEASURED 0.030 (0.762) AWAY FROM PACKAGE BODY.
4. RECOMMENDED BOLT CENTER DIMENSION OF 1.52 (38.61) BASED ON M3 SCREW.

DIM	INCHES		MILLIMETERS	
	MIN	MAX	MIN	MAX
A	1.615	1.625	41.02	41.28
B	0.395	0.405	10.03	10.29
C	0.150	0.200	3.81	5.08
D	0.455	0.465	11.56	11.81
E	0.062	0.066	1.57	1.68
F	0.004	0.007	0.10	0.18
G	1.400 BSC		35.56 BSC	
H	0.082	0.090	2.08	2.29
K	0.117	0.137	2.97	3.48
L	0.540 BSC		13.72 BSC	
M	1.219	1.241	30.96	31.52
N	1.218	1.242	30.94	31.55
Q	0.120	0.130	3.05	3.30
R	0.355	0.365	9.01	9.27
S	0.365	0.375	9.27	9.53
aaa	0.013 REF		0.33 REF	
bbb	0.010 REF		0.25 REF	
ccc	0.020 REF		0.51 REF	

### STYLE 1:

1. DRAIN
2. DRAIN
3. GATE
4. GATE
5. SOURCE

**CASE 375D-05  
ISSUE E  
NI-1230**

## **How to Reach Us:**

### **Home Page:**

www.freescale.com

### **E-mail:**

support@freescale.com

### **USA/Europe or Locations Not Listed:**

Freescale Semiconductor  
Technical Information Center, CH370  
1300 N. Alma School Road  
Chandler, Arizona 85224  
+1-800-521-6274 or +1-480-768-2130  
support@freescale.com

### **Europe, Middle East, and Africa:**

Freescale Halbleiter Deutschland GmbH  
Technical Information Center  
Schatzbogen 7  
81829 Muenchen, Germany  
+44 1296 380 456 (English)  
+46 8 52200080 (English)  
+49 89 92103 559 (German)  
+33 1 69 35 48 48 (French)  
support@freescale.com

### **Japan:**

Freescale Semiconductor Japan Ltd.  
Headquarters  
ARCO Tower 15F  
1-8-1, Shimo-Meguro, Meguro-ku,  
Tokyo 153-0064  
Japan  
0120 191014 or +81 3 5437 9125  
support.japan@freescale.com

### **Asia/Pacific:**

Freescale Semiconductor Hong Kong Ltd.  
Technical Information Center  
2 Dai King Street  
Tai Po Industrial Estate  
Tai Po, N.T., Hong Kong  
+800 2666 8080  
support.asia@freescale.com

### **For Literature Requests Only:**

Freescale Semiconductor Literature Distribution Center  
P.O. Box 5405  
Denver, Colorado 80217  
1-800-441-2447 or 303-675-2140  
Fax: 303-675-2150  
LDCForFreescaleSemiconductor@hibbertgroup.com

Information in this document is provided solely to enable system and software implementers to use Freescale Semiconductor products. There are no express or implied copyright licenses granted hereunder to design or fabricate any integrated circuits or integrated circuits based on the information in this document.

Freescale Semiconductor reserves the right to make changes without further notice to any products herein. Freescale Semiconductor makes no warranty, representation or guarantee regarding the suitability of its products for any particular purpose, nor does Freescale Semiconductor assume any liability arising out of the application or use of any product or circuit, and specifically disclaims any and all liability, including without limitation consequential or incidental damages. "Typical" parameters that may be provided in Freescale Semiconductor data sheets and/or specifications can and do vary in different applications and actual performance may vary over time. All operating parameters, including "Typicals", must be validated for each customer application by customer's technical experts. Freescale Semiconductor does not convey any license under its patent rights nor the rights of others. Freescale Semiconductor products are not designed, intended, or authorized for use as components in systems intended for surgical implant into the body, or other applications intended to support or sustain life, or for any other application in which the failure of the Freescale Semiconductor product could create a situation where personal injury or death may occur. Should Buyer purchase or use Freescale Semiconductor products for any such unintended or unauthorized application, Buyer shall indemnify and hold Freescale Semiconductor and its officers, employees, subsidiaries, affiliates, and distributors harmless against all claims, costs, damages, and expenses, and reasonable attorney fees arising out of, directly or indirectly, any claim of personal injury or death associated with such unintended or unauthorized use, even if such claim alleges that Freescale Semiconductor was negligent regarding the design or manufacture of the part.

Freescale™ and the Freescale logo are trademarks of Freescale Semiconductor, Inc. All other product or service names are the property of their respective owners.

© Freescale Semiconductor, Inc. 2006. All rights reserved.

