

Data Sheet

HAL[®] 5xy

Hall-Effect Sensor Family

Copyright, Warranty, and Limitation of Liability

The information and data contained in this document are believed to be accurate and reliable. The software and proprietary information contained therein may be protected by copyright, patent, trademark and/or other intellectual property rights of Micronas. All rights not expressly granted remain reserved by Micronas.

Micronas assumes no liability for errors and gives no warranty representation or guarantee regarding the suitability of its products for any particular purpose due to these specifications.

By this publication, Micronas does not assume responsibility for patent infringements or other rights of third parties which may result from its use. Commercial conditions, product availability and delivery are exclusively subject to the respective order confirmation.

Any information and data which may be provided in the document can and do vary in different applications, and actual performance may vary over time.

All operating parameters must be validated for each customer application by customers' technical experts. Any new issue of this document invalidates previous issues. Micronas reserves the right to review this document and to make changes to the document's content at any time without obligation to notify any person or entity of such revision or changes. For further advice please contact us directly.

Do not use our products in life-supporting systems, aviation and aerospace applications! Unless explicitly agreed to otherwise in writing between the parties, Micronas' products are not designed, intended or authorized for use as components in systems intended for surgical implants into the body, or other applications intended to support or sustain life, or for any other application in which the failure of the product could create a situation where personal injury or death could occur.

No part of this publication may be reproduced, photocopied, stored on a retrieval system or transmitted without the express written consent of Micronas.

Micronas Trademarks

– HAL

Micronas Patents

Choppered Offset Compensation protected by Micronas patents no. US5260614, US5406202, EP0525235 and EP0548391.

Third-Party Trademarks

All other brand and product names or company names may be trademarks of their respective companies.

Contents

Page	Section	Title
4	1.	Introduction
4	1.1.	Features:
4	1.2.	Family Overview
5	1.3.	Marking Code
5	1.4.	Operating Junction Temperature Range
5	1.5.	Hall Sensor Package Codes
6	1.6.	Solderability and Welding
7	2.	Functional Description
8	3.	Specifications
8	3.1.	Outline Dimensions
13	3.2.	Dimensions of Sensitive Area
13	3.3.	Positions of Sensitive Areas
13	3.4.	Absolute Maximum Ratings
13	3.4.1.	Storage and Shelf Life
14	3.5.	Recommended Operating Conditions
15	3.6.	Characteristics
16	3.7.	Magnetic Characteristics Overview
22	4.	Type Description
22	4.1.	HAL 501
24	4.2.	HAL 502
26	4.3.	HAL 503
28	4.4.	HAL 504
30	4.5.	HAL 505
32	4.6.	HAL 506
34	4.7.	HAL 507
36	4.8.	HAL 508
38	4.9.	HAL 509
40	4.10.	HAL 516
42	4.11.	HAL 519
44	4.12.	HAL 523
46	5.	Application Notes
46	5.1.	Ambient Temperature
46	5.2.	Extended Operating Conditions
46	5.3.	Start-Up Behavior
46	5.4.	EMC and ESD
48	6.	Data Sheet History

Hall Effect Sensor Family in CMOS technology

Release Note: Revision bars indicate significant changes to the previous edition.

1. Introduction

The HAL 5xy family consists of different Hall switches produced in CMOS technology. All sensors include a temperature-compensated Hall plate with active offset compensation, a comparator, and an open-drain output transistor. The comparator compares the actual magnetic flux through the Hall plate (Hall voltage) with the fixed reference values (switching points). Accordingly, the output transistor is switched on or off.

The sensors of this family differ in the switching behavior and the switching points.

The active offset compensation leads to constant magnetic characteristics over supply voltage and temperature range. In addition, the magnetic parameters are robust against mechanical stress effects.

The sensors are designed for industrial and automotive applications and operate with supply voltages from 3.8 V to 24 V in the ambient temperature range from -40 °C up to 150 °C.

All sensors are available in the SMD-package SOT89B-1 and in the leaded versions TO92UA-1 and TO92UA-2.

1.1. Features:

- switching offset compensation at typically 62 kHz
- operates from 3.8 V to 24 V supply voltage
- overvoltage protection at all pins
- reverse-voltage protection at V_{DD} -pin
- magnetic characteristics are robust regarding mechanical stress effects
- short-circuit protected open-drain output by thermal shut down
- operates with static magnetic fields and dynamic magnetic fields up to 10 kHz
- constant switching points over a wide supply voltage range
- the decrease of magnetic flux density caused by rising temperature in the sensor system is compensated by a built-in negative temperature coefficient of the magnetic characteristics
- ideal sensor for applications in extreme automotive and industrial environments
- EMC corresponding to ISO 7637

1.2. Family Overview

The types differ according to the magnetic flux density values for the magnetic switching points and the temperature behavior of the magnetic switching points, and the mode of switching.

Type	Switching Behavior	Sensitivity	see Page
501	bipolar	very high	22
502	unipolar	low	24
503	unipolar	high	26
504	unipolar	medium	28
505	latching	low	30
506	unipolar	high	32
507	unipolar	medium	34
508	unipolar	medium	36
509	unipolar	low	38
516	unipolar with inverted output	high	40
519	unipolar with inverted output (north polarity)	high	42
523	unipolar	low	44

Latching Sensors:

The output turns low with the magnetic south pole on the branded side of the package and turns high with the magnetic north pole on the branded side. The output does not change if the magnetic field is removed. For changing the output state, the opposite magnetic field polarity must be applied.

Bipolar Switching Sensors:

The output turns low with the magnetic south pole on the branded side of the package and turns high with the magnetic north pole on the branded side. The output state is not defined for all sensors if the magnetic field is removed again. Some sensors will change the output state and some sensors will not.

Unipolar Switching Sensors:

The output turns low with the magnetic south pole on the branded side of the package and turns high if the magnetic field is removed. The sensor does not respond to the magnetic north pole on the branded side.

Unipolar Switching Sensors with Inverted Output:

The output turns high with the magnetic south pole on the branded side of the package and turns low if the magnetic field is removed. The sensor does not respond to the magnetic north pole on the branded side.

Unipolar Switching Sensors with Inverted Output Sensitive to North Pole:

The output turns high with the magnetic north pole on the branded side of the package and turns low if the magnetic field is removed. The sensor does not respond to the magnetic south pole on the branded side.

1.3. Marking Code

All Hall sensors have a marking on the package surface (branded side). This marking includes the name of the sensor and the temperature range.

Type	Temperature Range	
	A	K
HAL 501	501A	501K
HAL 502	502A	502K
HAL 503	503A	503K
HAL 504	504A	504K
HAL 505	505A	505K
HAL 506	506A	506K
HAL 507	507A	507K
HAL 508	508A	508K
HAL 509	509A	509K
HAL 516	516A	516K
HAL 519	519A	519K
HAL 523	523A	523K

1.4. Operating Junction Temperature Range

The Hall sensors from Micronas are specified to the chip temperature (junction temperature T_J).

A: $T_J = -40\text{ °C to }+170\text{ °C}$

K: $T_J = -40\text{ °C to }+140\text{ °C}$

Note: Due to the high power dissipation at high current consumption, there is a difference between the ambient temperature (T_A) and junction temperature. Please refer to Section 5.1. on page 46 for details.

1.5. Hall Sensor Package Codes

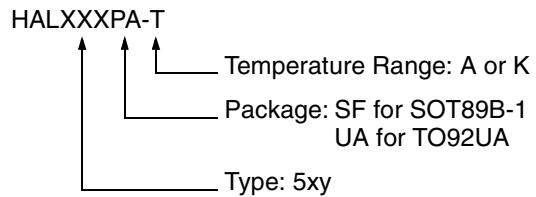

Example: **HAL505UA-K**

- Type: 505
- Package: TO92UA
- Temperature Range: $T_J = -40\text{ °C to }+140\text{ °C}$

Hall sensors are available in a wide variety of packaging versions and quantities. For more detailed information, please refer to the brochure: "Ordering Codes for Hall Sensors".

1.6. Solderability and Welding

Soldering

During soldering reflow processing and manual reworking, a component body temperature of 260 °C should not be exceeded.

Welding

Device terminals should be compatible with laser and resistance welding. Please note that the success of the welding process is subject to different welding parameters which will vary according to the welding technique used. A very close control of the welding parameters is absolutely necessary in order to reach satisfying results. Micronas, therefore, does not give any implied or express warranty as to the ability to weld the component.

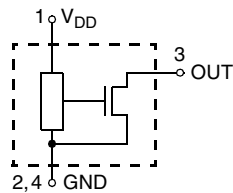

Fig. 1-1: Pin configuration

2. Functional Description

The HAL 5xx sensors are monolithic integrated circuits which switch in response to magnetic fields. If a magnetic field with flux lines perpendicular to the sensitive area is applied to the sensor, the biased Hall plate forces a Hall voltage proportional to this field. The Hall voltage is compared with the actual threshold level in the comparator. The temperature-dependent bias increases the supply voltage of the Hall plates and adjusts the switching points to the decreasing induction of magnets at higher temperatures. If the magnetic field exceeds the threshold levels, the open drain output switches to the appropriate state. The built-in hysteresis eliminates oscillation and provides switching behavior of output without bouncing.

Magnetic offset caused by mechanical stress is compensated for by using the “switching offset compensation technique”. Thus, an internal oscillator provides a two-phase clock. The Hall voltage is sampled at the end of the first phase. At the end of the second phase, both sampled and actual Hall voltages are averaged and compared with the actual switching point. Subsequently, the open drain output switches to the appropriate state. The time from crossing the magnetic switching level to switching of output can vary between zero and $1/f_{osc}$.

Shunt protection devices clamp voltage peaks at the output pin and V_{DD} pin together with external series resistors. Reverse current is limited at the V_{DD} pin by an internal series resistor up to -15 V . No external reverse protection diode is needed at the V_{DD} pin for reverse voltages ranging from 0 V to -15 V .

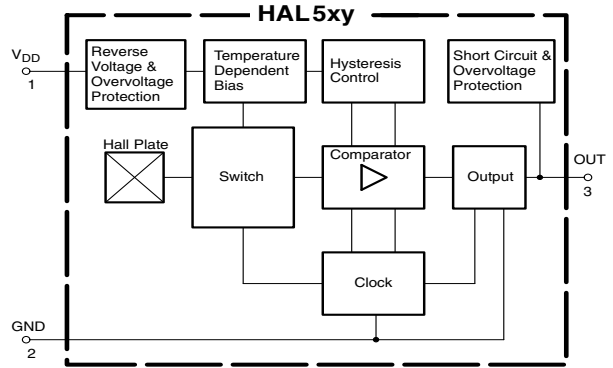

Fig. 2-1: HAL 5xx block diagram

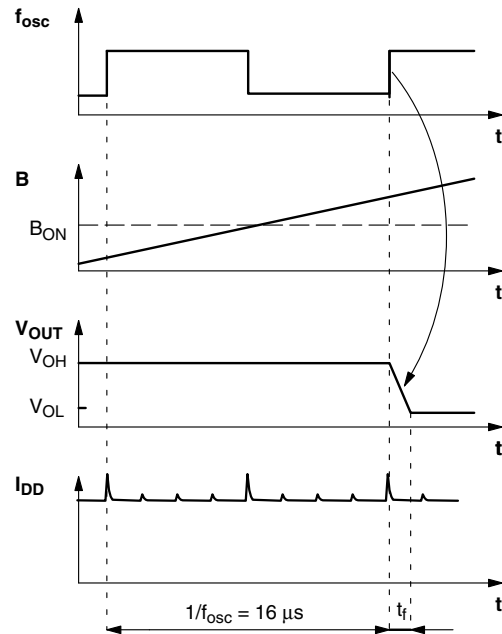

Fig. 2-2: Timing diagram

3. Specifications

3.1. Outline Dimensions

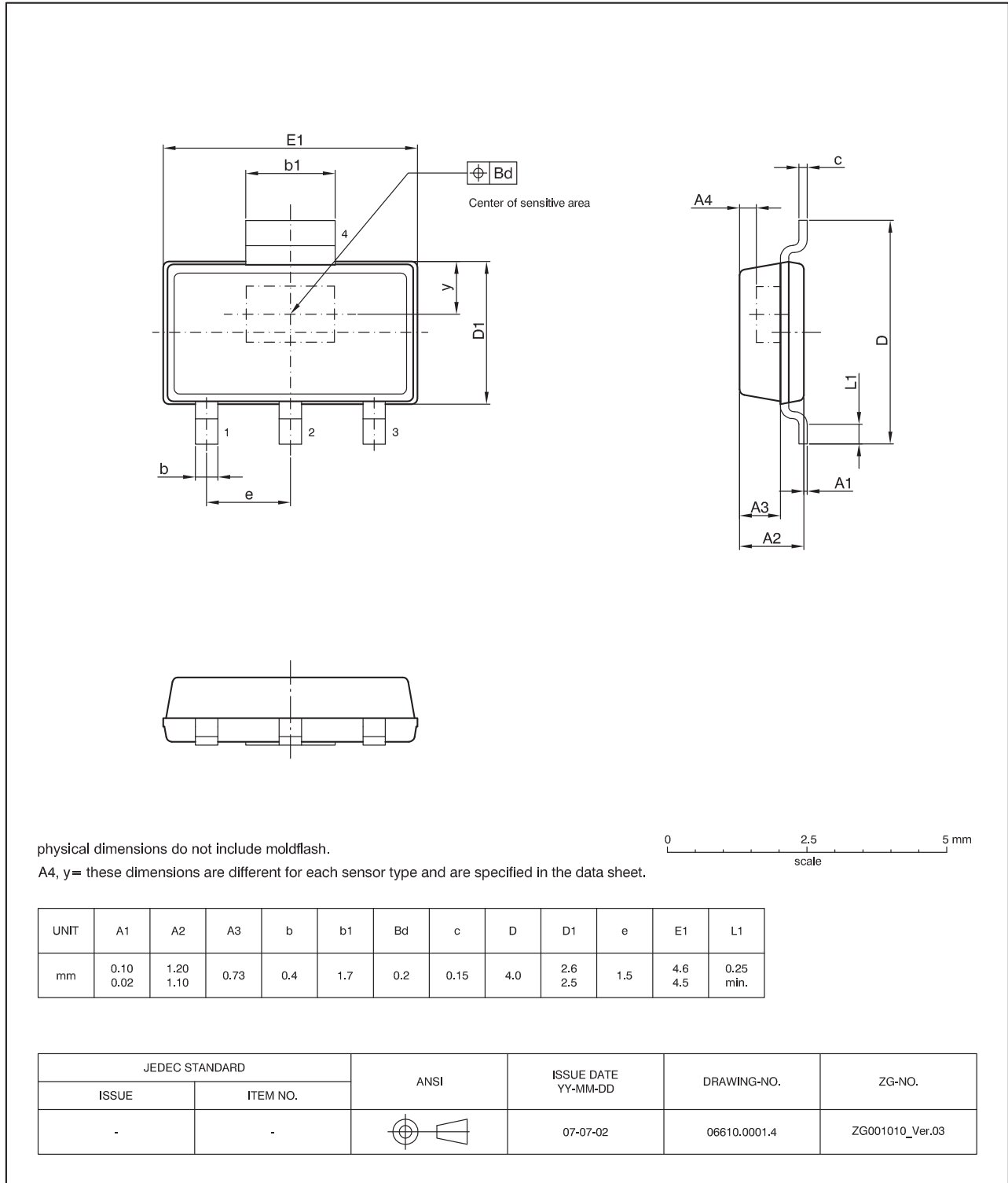

Fig. 3-1:
SOT89B-1: Plastic Small Outline Transistor package, 4 leads
 Ordering code: SF
 Weight approximately 0.034 g

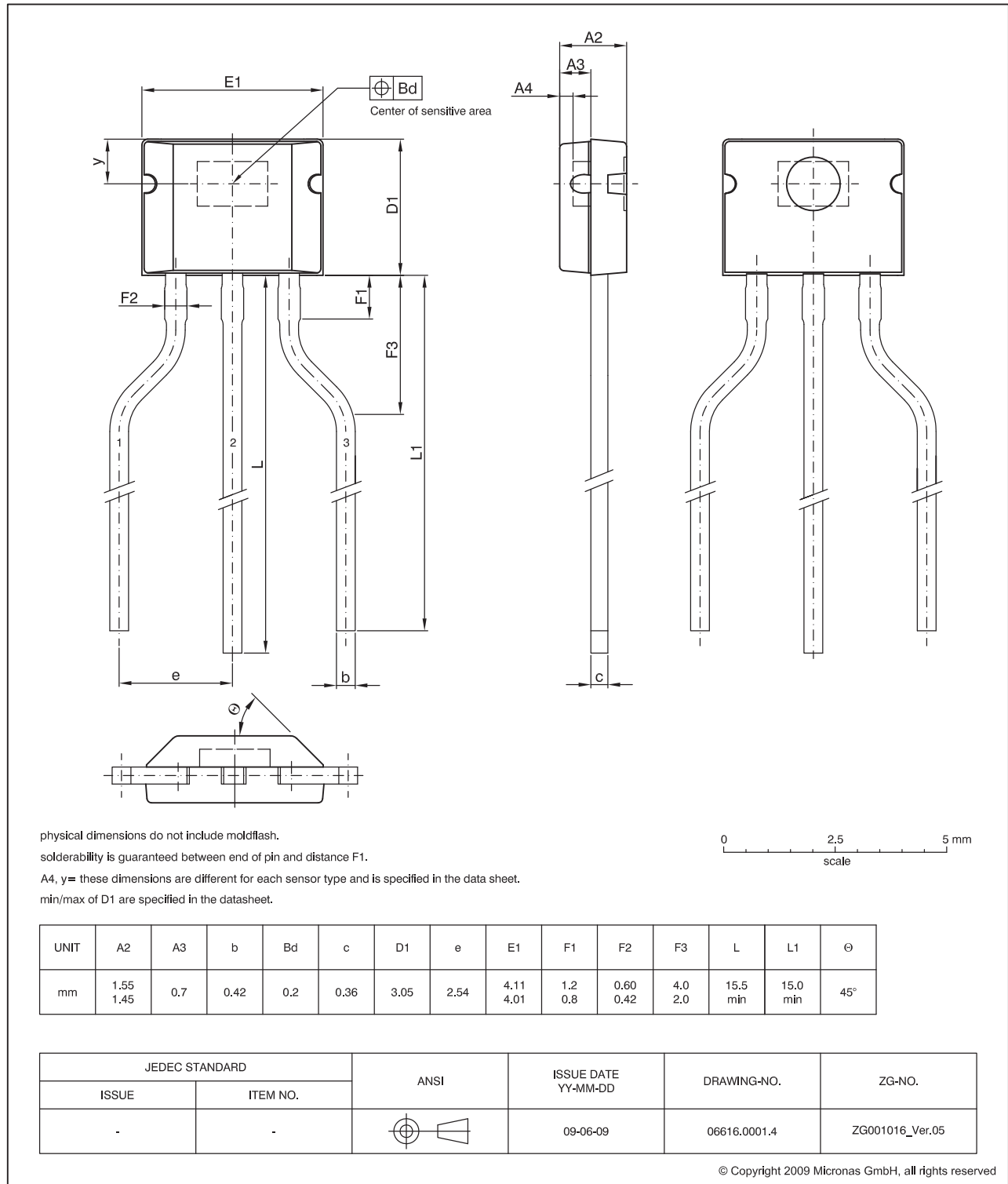

Fig. 3-2:
TO92UA-1: Plastic Transistor Standard UA package, 3 leads, spread
 Weight approximately 0.106 g

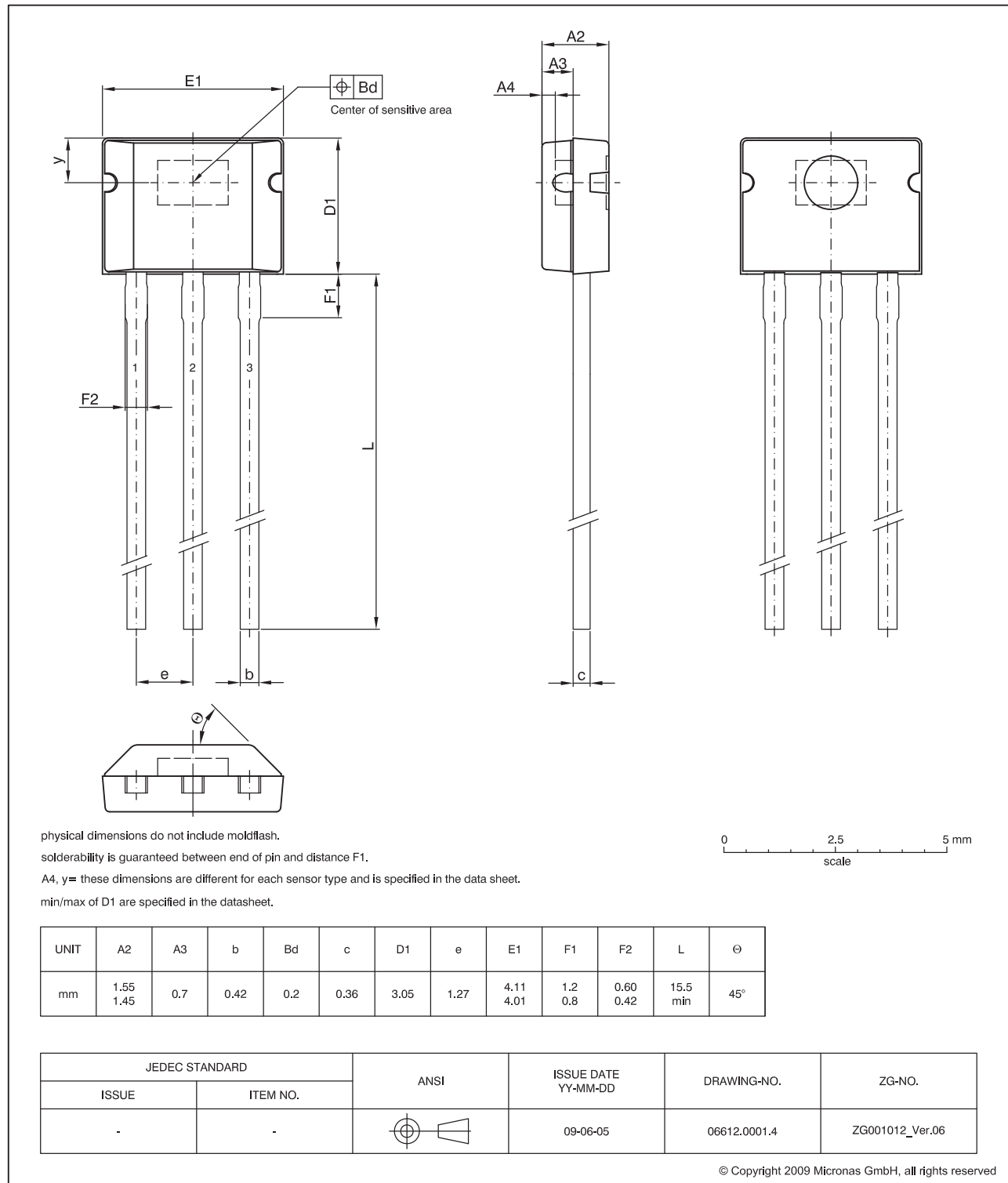

Fig. 3-3:
TO92UA-2: Plastic Transistor Standard UA package, 3 leads, not spread
 Weight approximately 0.106 g

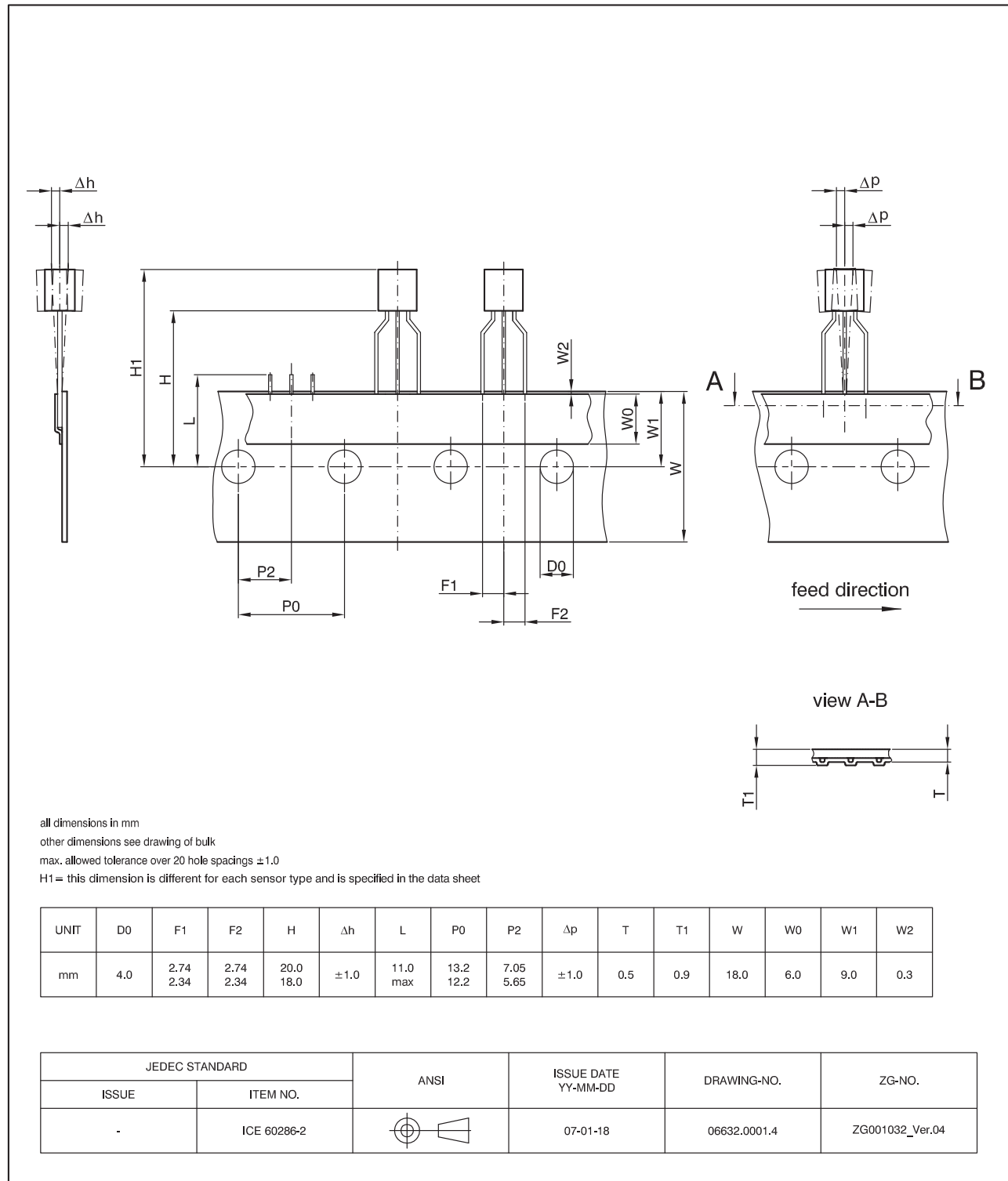

Fig. 3-4:
T092UA-1: Dimensions ammpack inline, spread

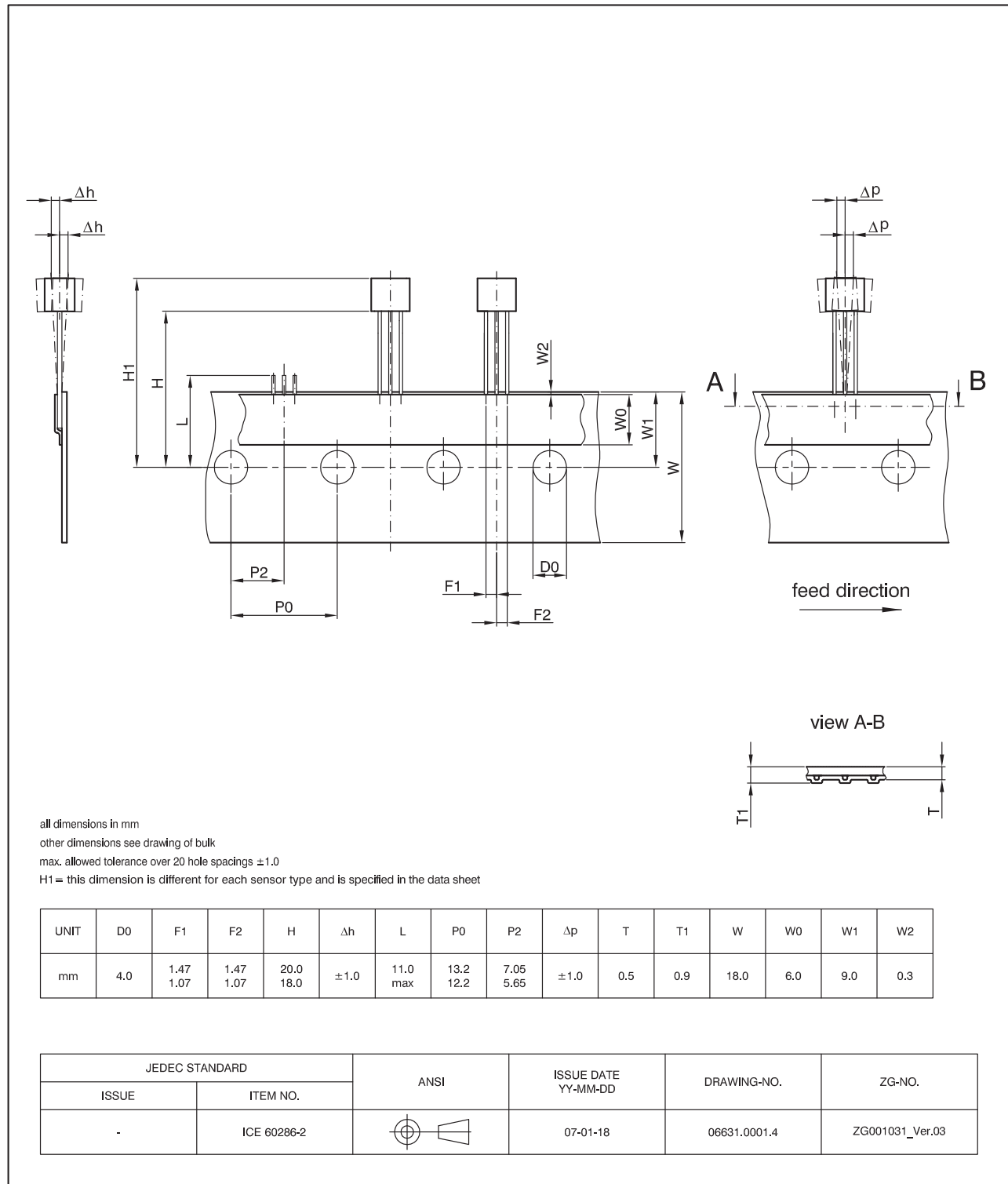

Fig. 3-5:
TO92UA-2: Dimensions ammopack inline, not spread

3.2. Dimensions of Sensitive Area

0.25 mm × 0.12 mm

3.3. Positions of Sensitive Areas

	SOT89B-1	TO92UA-1/-2
y	0.95 mm nominal	1.0 mm nominal
A4	0.3 mm nominal	0.3 mm nominal
D1	see drawing	3.05 mm +/- 0.05 mm
H1	not applicable	min. 21 mm max. 23.1 mm

3.4. Absolute Maximum Ratings

Stresses beyond those listed in the “Absolute Maximum Ratings” may cause permanent damage to the device. This is a stress rating only. Functional operation of the device at these conditions is not implied. Exposure to absolute maximum rating conditions for extended periods will affect device reliability.

This device contains circuitry to protect the inputs and outputs against damage due to high static voltages or electric fields; however, it is advised that normal precautions be taken to avoid application of any voltage higher than absolute maximum-rated voltages to this circuit.

All voltages listed are referenced to ground (GND).

Symbol	Parameter	Pin No.	Min.	Max.	Unit
V _{DD}	Supply Voltage	1	-15	28 ¹⁾	V
V _O	Output Voltage	3	-0.3	28 ¹⁾	V
I _O	Continuous Output On Current	3	-	50 ¹⁾	mA
T _J	Junction Temperature Range		-40	170 ²⁾	°C
¹⁾ as long as T _J max is not exceeded ²⁾ t < 1000 h					

3.4.1. Storage and Shelf Life

The permissible storage time (shelf life) of the sensors is unlimited, provided the sensors are stored at a maximum of 30 °C and a maximum of 85% relative humidity. At these conditions, no Dry Pack is required.

Solderability is guaranteed for one year from the date code on the package.

3.5. Recommended Operating Conditions

Functional operation of the device beyond those indicated in the “Recommended Operating Conditions” of this specification is not implied, may result in unpredictable behavior of the device and may reduce reliability and lifetime.

All voltages listed are referenced to ground (GND).

Symbol	Parameter	Pin No.	Min.	Max.	Unit
V_{DD}	Supply Voltage	1	3.8	24	V
I_O	Continuous Output On Current	3	0	20	mA
V_O	Output Voltage (output switched off)	3	0	24	V

3.6. Characteristics

at $T_J = -40\text{ }^\circ\text{C}$ to $+170\text{ }^\circ\text{C}$, $V_{DD} = 3.8\text{ V}$ to 24 V ,

at Recommended Operation Conditions if not otherwise specified in the column “Conditions”. Typical Characteristics for $T_J = 25\text{ }^\circ\text{C}$ and $V_{DD} = 12\text{ V}$

Symbol	Parameter	Pin No.	Min.	Typ.	Max.	Unit	Conditions
I_{DD}	Supply Current	1	2.3	3	4.2	mA	$T_J = 25\text{ }^\circ\text{C}$
I_{DD}	Supply Current over Temperature Range	1	1.6	3	5.2	mA	
V_{DDZ}	Overshoot Protection at Supply	1	–	28.5	32	V	$I_{DD} = 25\text{ mA}$, $T_J = 25\text{ }^\circ\text{C}$, $t = 20\text{ ms}$
V_{OZ}	Overshoot Protection at Output	3	–	28	32	V	$I_{OH} = 25\text{ mA}$, $T_J = 25\text{ }^\circ\text{C}$, $t = 20\text{ ms}$
V_{OL}	Output Voltage	3	–	130	280	mV	$I_{OL} = 20\text{ mA}$, $T_J = 25\text{ }^\circ\text{C}$
V_{OL}	Output Voltage over Temperature Range	3	–	130	400	mV	$I_{OL} = 20\text{ mA}$
I_{OH}	Output Leakage Current	3	–	0.06	0.1	μA	Output switched off, $T_J = 25\text{ }^\circ\text{C}$, $V_{OH} = 3.8\text{ to }24\text{ V}$
I_{OH}	Output Leakage Current over Temperature Range	3	–	–	10	μA	Output switched off, $T_J \leq 150\text{ }^\circ\text{C}$, $V_{OH} = 3.8\text{ to }24\text{ V}$
f_{osc}	Internal Oscillator Chopper Frequency	–	–	62	–	kHz	
$t_{en(O)}$	Enable Time of Output after Setting of V_{DD}	1	–	50	–	μs	$V_{DD} = 12\text{ V}$ ¹⁾
t_r	Output Rise Time	3	–	75	400	ns	$V_{DD} = 12\text{ V}$, $R_L = 820\text{ Ohm}$, $C_L = 20\text{ pF}$
t_f	Output Fall Time	3	–	50	400	ns	
R_{thJSB} case SOT89B-1	Thermal Resistance Junction to Substrate Backside	–	–	150	200	K/W	Fiberglass Substrate 30 mm x 10 mm x 1.5 mm, pad size see Fig. 3–6
R_{thJA} case TO92UA-1, TO92UA-2	Thermal Resistance Junction to Soldering Point	–	–	150	200	K/W	

¹⁾ $B > B_{ON} + 2\text{ mT}$ or $B < B_{OFF} - 2\text{ mT}$ for HAL50x, $B > B_{OFF} + 2\text{ mT}$ or $B < B_{ON} - 2\text{ mT}$ for HAL51x

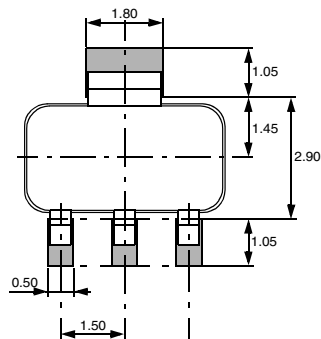

Fig. 3–6: Recommended pad size SOT89B-1
Dimensions in mm

3.7. Magnetic Characteristics Overview

at T_J = -40 °C to +170 °C, V_{DD} = 3.8 V to 24 V, Typical Characteristics for V_{DD} = 12 V

Magnetic flux density values of switching points.

Positive flux density values refer to the magnetic south pole at the branded side of the package.

Sensor Switching Type	Parameter T _J	On point B _{ON}			Off point B _{OFF}			Hysteresis B _{HYS}			Unit
		Min.	Typ.	Max.	Min.	Typ.	Max.	Min.	Typ.	Max.	
HAL 501 bipolar	-40 °C	-0.8	0.6	2.5	-2.5	-0.8	0.8	0.5	1.4	2	mT
	25 °C	-0.5	0.5	2.3	-2.3	-0.7	0.5	0.5	1.2	1.9	mT
	170 °C	-1.5	0.7	3	-2.5	-0.2	2	0.4	0.9	1.8	mT
HAL 502 latching	-40 °C	1	2.8	5	-5	-2.8	-1	4.5	5.6	7.2	mT
	25 °C	1	2.6	4.5	-4.5	-2.6	-1	4.5	5.2	7	mT
	170 °C	0.9	2.3	4.3	-4.3	-2.3	-0.9	3.5	4.6	6.8	mT
HAL 503 latching	-40 °C	6.4	8.6	10.8	-10.8	-8.6	-6.4	14.6	17.2	20.6	mT
	25 °C	6	8	10	-10	-8	-6	13.6	16	18	mT
	170 °C	4	6.4	8.9	-8.9	-6	-4	11	12.4	16	mT
HAL 504 unipolar	-40 °C	10.3	13	15.7	5.3	7.5	9.6	4.4	5.5	6.5	mT
	25 °C	9.5	12	14.5	5	7	9	4	5	6.5	mT
	170 °C	8.5	10.2	13.7	4.2	5.9	8.5	3.2	4.3	6.4	mT
HAL 505 latching	-40 °C	11.8	15	18.3	-18.3	-15	-11.8	26	30	34	mT
	25 °C	11	13.5	17	-17	-13.5	-11	24	27	32	mT
	170 °C	9.4	11.7	16.1	-16.1	-11.7	-9.4	20	23.4	31.3	mT
HAL 506 unipolar	-40 °C	4.3	5.9	7.7	2.1	3.8	5.4	1.6	2.1	2.8	mT
	25 °C	3.8	5.5	7.2	2	3.5	5	1.5	2	2.7	mT
	170 °C	3.2	4.6	6.8	1.7	3	5.2	0.9	1.6	2.6	mT
HAL 507 unipolar	-40 °C	15.5	19.6	22.5	14.0	17.1	21.5	1.6	2.5	5.2	mT
	25 °C	15.0	18.3	20.7	13.5	16.2	19.0	1.5	2.1	2.7	mT
	170 °C	10.5	13.7	20.0	9.0	12.3	18.0	0.8	1.4	2.4	mT
HAL 508 unipolar	-40 °C	15.5	19	21.9	14	16.7	20	1.6	2.3	2.8	mT
	25 °C	15	18	20.7	13.5	16	19	1.5	2	2.7	mT
	170 °C	12.7	15.3	20	11.4	13.6	18.3	1	1.7	2.6	mT
HAL 509 unipolar	-40 °C	23.1	27.4	31.1	19.9	23.8	27.2	2.9	3.6	3.9	mT
	25 °C	23.1	26.8	30.4	19.9	23.2	26.6	2.8	3.5	3.9	mT
	170 °C	21.3	25.4	28.9	18.3	22.1	25.3	2.5	3.3	3.8	mT
HAL 516 unipolar inverted	-40 °C	2.1	3.8	5.4	4.3	5.9	7.7	1.6	2.1	2.8	mT
	25 °C	2	3.5	5	3.8	5.5	7.2	1.5	2	2.7	mT
	170 °C	1.7	3	5.2	3.2	4.6	6.8	0.9	1.6	2.6	mT

Note: For detailed descriptions of the individual types, see pages 22 and following.

Magnetic Characteristics Overview, continued

Sensor Switching Type	Parameter T _J	On point _{ON}			Off point _{OFF}			Hysteresis B _{HYS}			Unit
		Min.	Typ.	Max.	Min.	Typ.	Max.	Min.	Typ.	Max.	
HAL 519 unipolar inverted	-40 °C	-5.4	-3.8	-2.1	-7.7	-5.9	-4.3	1.6	2.1	2.8	mT
	25 °C	-5	-3.6	-2	-7.2	-5.5	-3.8	1.5	1.9	2.7	mT
	170 °C	-5.2	-3.0	-1.5	-6.8	-4.6	-2.8	0.9	1.6	2.6	mT
HAL 523 unipolar	-40 °C	28	34.5	42	18	24	30	7	10.5	14	mT
	25 °C	28	34.5	42	18	24	30	7	10.5	14	mT
	170 °C	28	34.5	42	18	24	30	7	10.5	14	mT

Note: For detailed descriptions of the individual types, see pages 22 and following

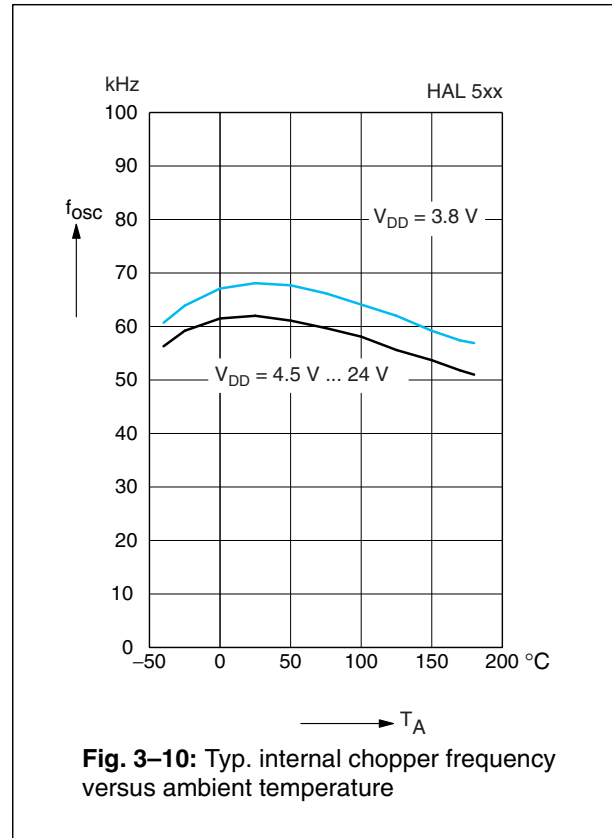
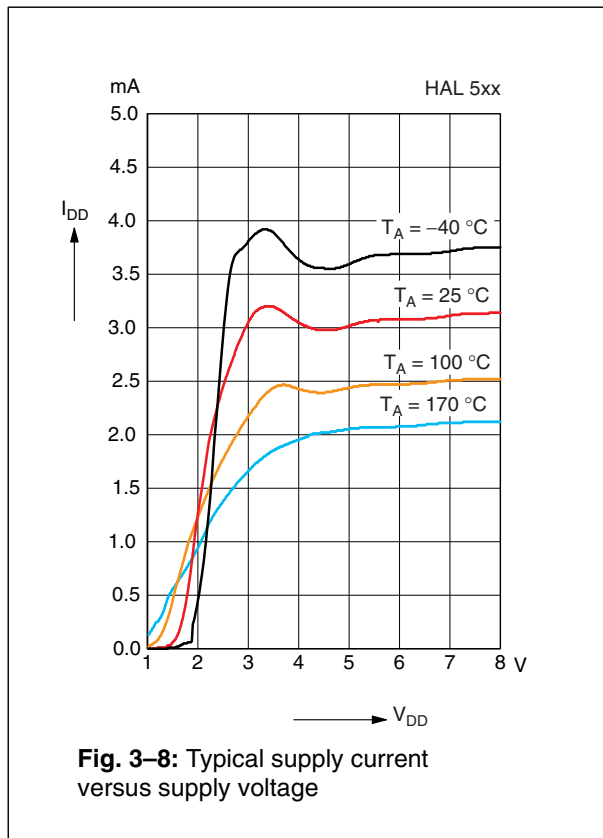
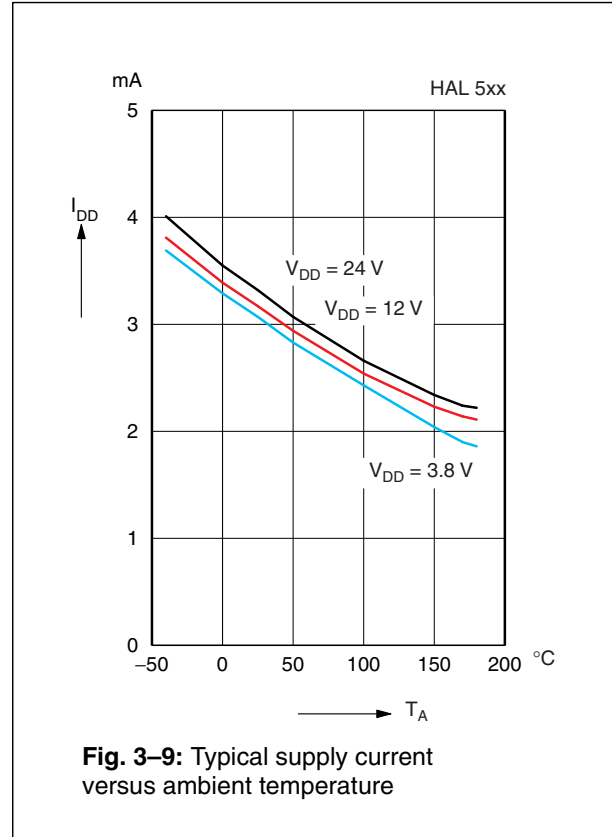
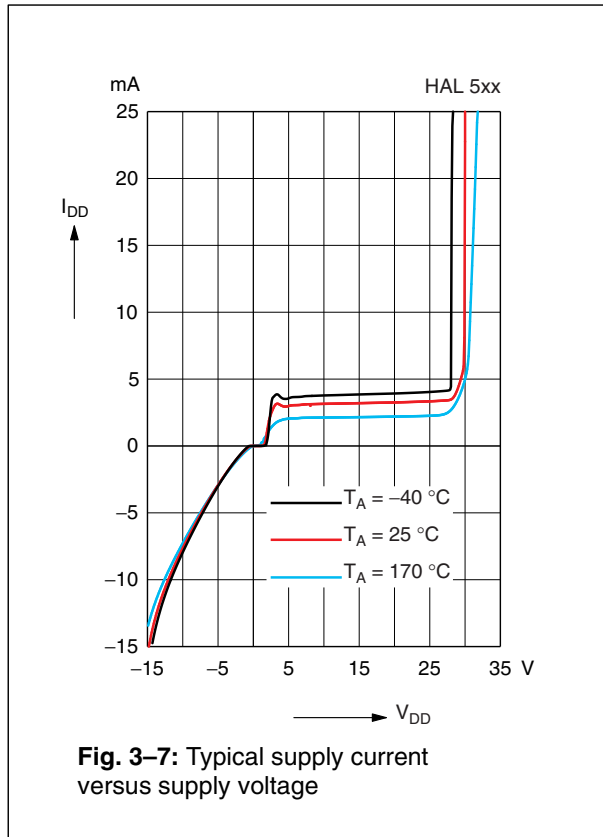

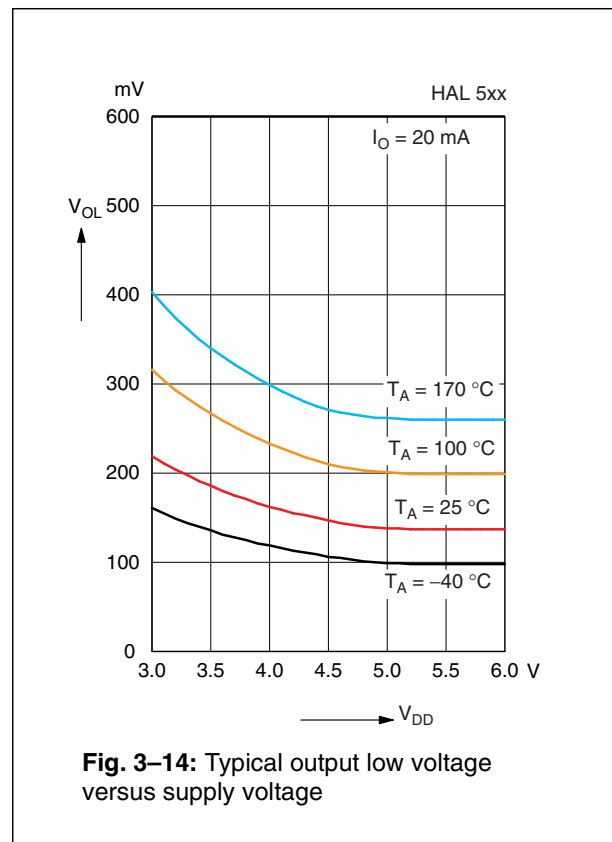
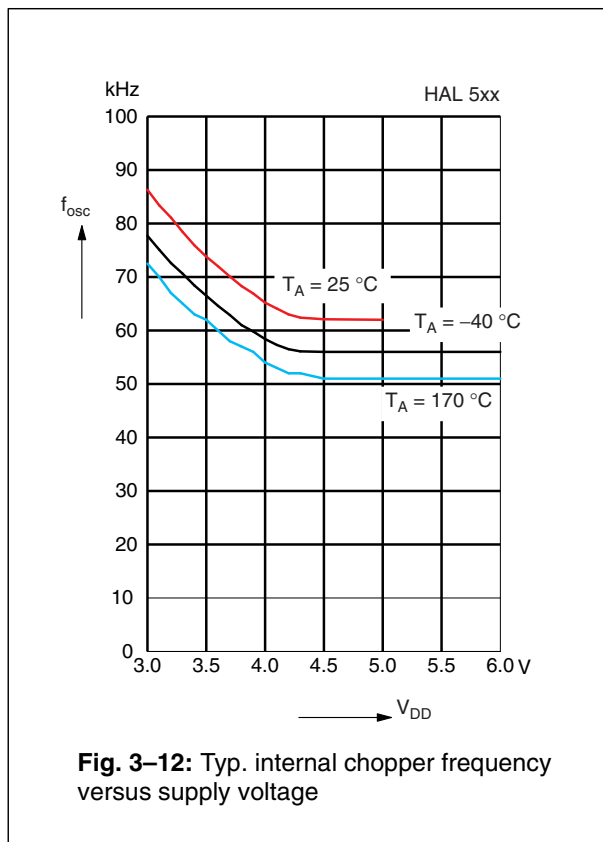
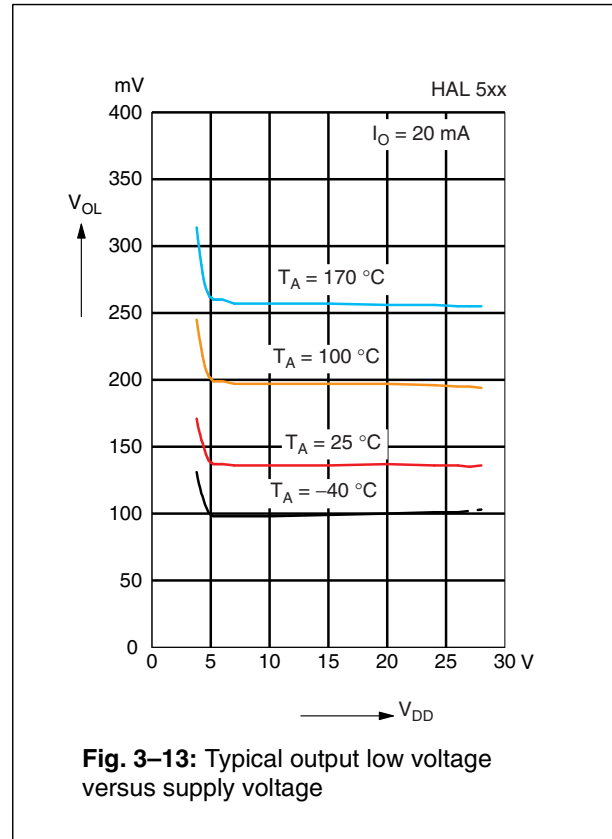
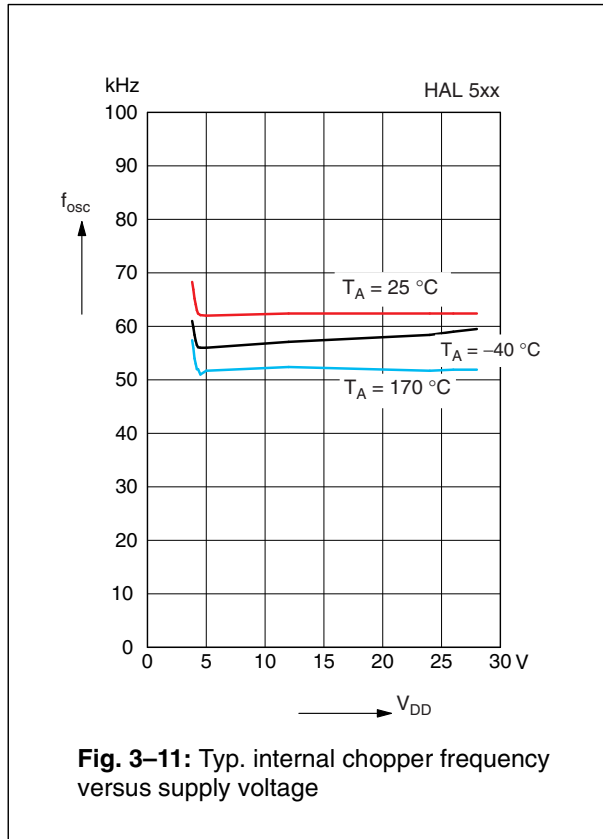

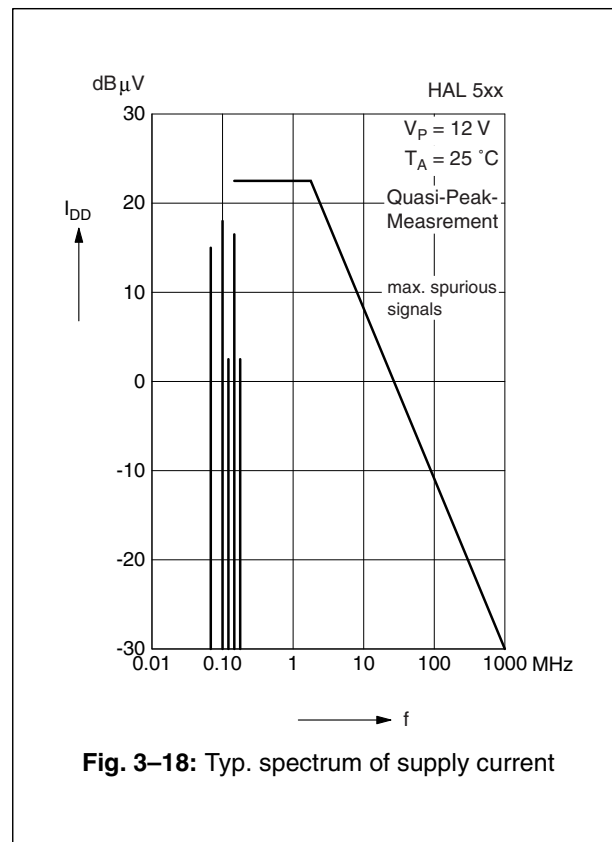
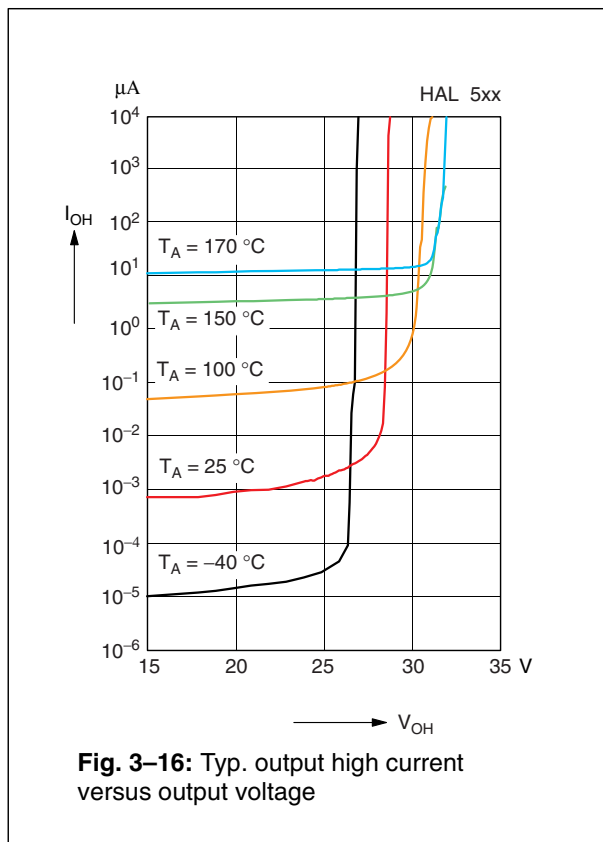
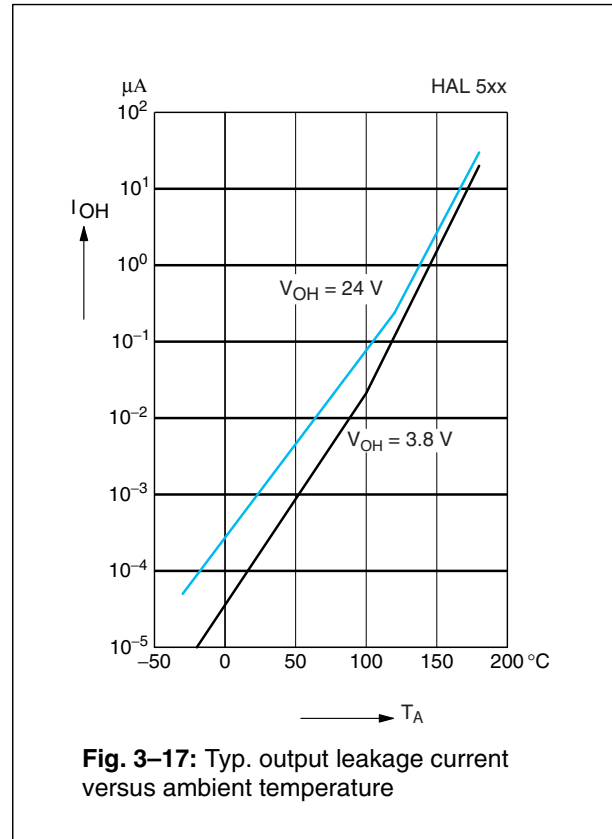
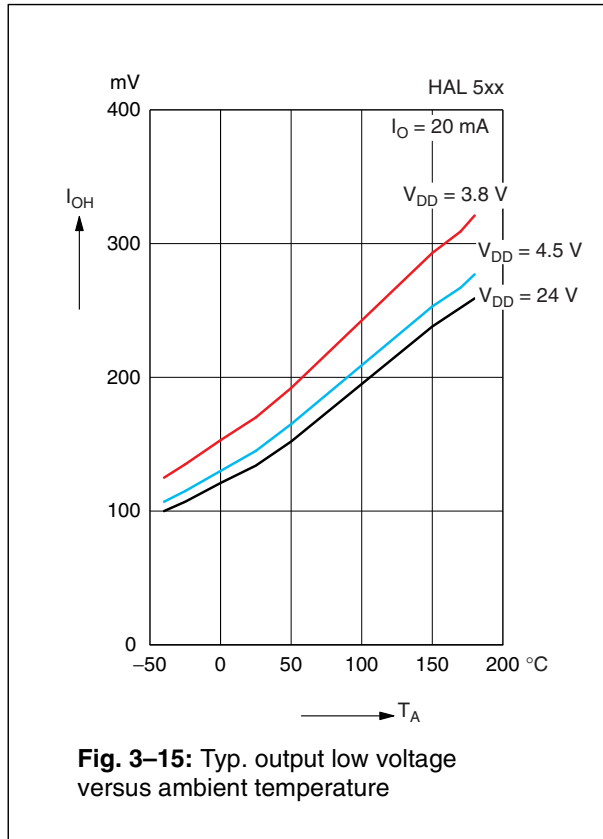

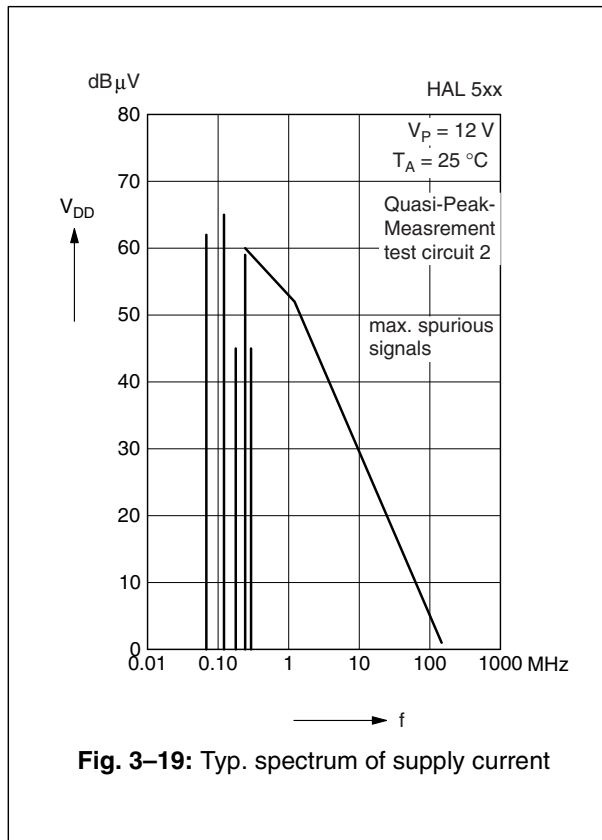

4. Type Description

4.1. HAL 501

The HAL 501 is the most sensitive sensor of this family with bipolar switching behavior (see Fig. 4.1.).

The output turns low with the magnetic south pole on the branded side of the package and turns high with the magnetic north pole on the branded side. The output state is not defined for all sensors if the magnetic field is removed again. Some sensors will change the output state and some sensors will not.

For correct functioning in the application, the sensor requires both magnetic polarities (north and south) on the branded side of the package.

Magnetic Features:

- switching type: bipolar
- very high sensitivity
- typical B_{ON} : 0.5 mT at room temperature
- typical B_{OFF} : -0.7 mT at room temperature
- operates with static magnetic fields and dynamic magnetic fields up to 10 kHz

Applications

The HAL 501 is the optimal sensor for applications with alternating magnetic signals and weak magnetic amplitude at the sensor position such as:

- applications with large air gap or weak magnets,
- rotating speed measurement,
- commutation of brushless DC motors, and
- CAM shaft sensors, and
- magnetic encoders.

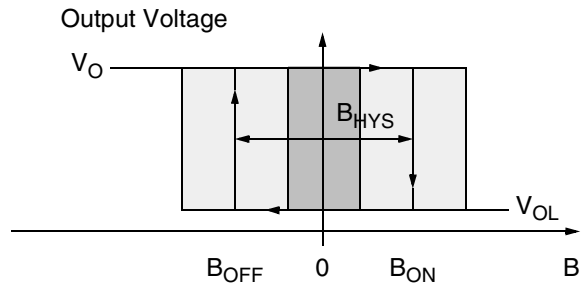

Fig. 4-1: Definition of magnetic switching points for HAL 501

Magnetic Characteristics at $T_J = -40\text{ °C to }+170\text{ °C}$, $V_{DD} = 3.8\text{ V to }24\text{ V}$, Typical Characteristics for $V_{DD} = 12\text{ V}$

Magnetic flux density values of switching points.

Positive flux density values refer to the magnetic south pole at the branded side of the package.

Parameter	On point B_{ON}			Off point B_{OFF}			Hysteresis B_{HYS}			Magnetic Offset B_{OFFSET}			Unit
	Min.	Typ.	Max.	Min.	Typ.	Max.	Min.	Typ.	Max.	Min.	Typ.	Max.	
T_J													
-40 °C	-0.8	0.6	2.5	-2.5	-0.8	0.8	0.5	1.4	2		-0.1		mT
25 °C	-0.5	0.5	2.3	-2.3	-0.7	0.5	0.5	1.2	1.9	-1.4	-0.1	1.4	mT
140 °C	-1.2	0.6	2.8	-2.5	-0.5	1.3	0.5	1.1	1.8		0		mT
170 °C	-1.5	0.7	3	-2.5	-0.2	2	0.4	0.9	1.8		0.2		mT

The hysteresis is the difference between the switching points $B_{HYS} = B_{ON} - B_{OFF}$

The magnetic offset is the mean value of the switching points $B_{OFFSET} = (B_{ON} + B_{OFF}) / 2$

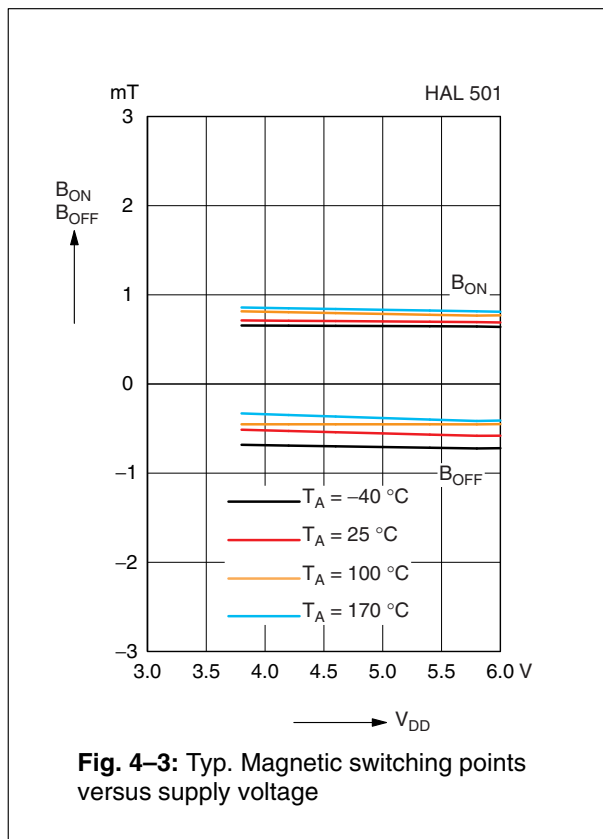
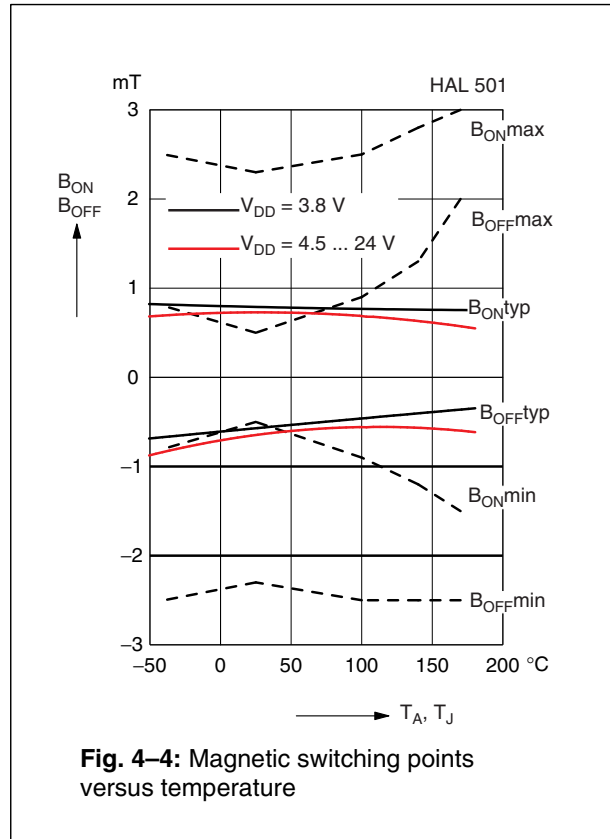
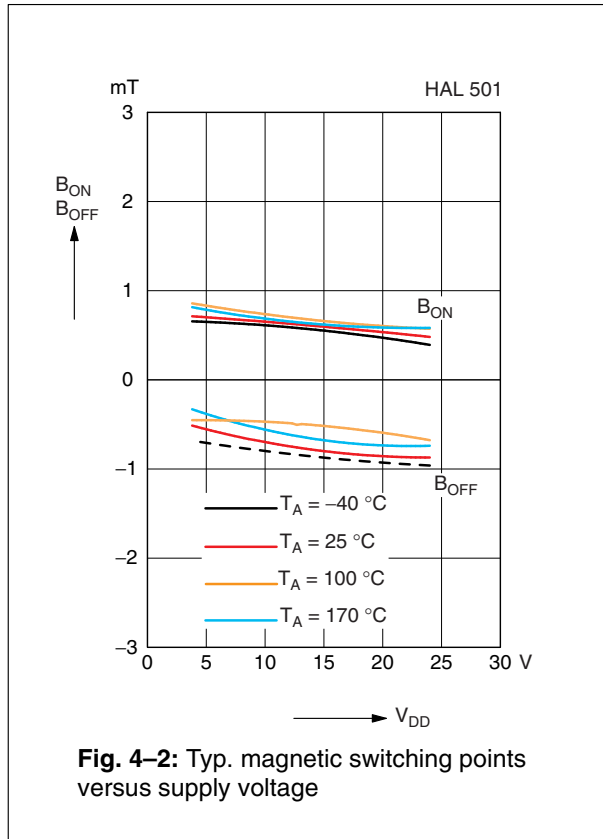

Note: In the diagram “Magnetic switching points versus temperature” the curves for: B_{ONmin} , B_{ONmax} , B_{OFFmin} , and B_{OFFmax} refer to junction temperature, whereas typical curves refer to ambient temperature.

4.2. HAL 502

The HAL 502 is the most sensitive latching sensor of this family (see Fig. 4–5).

The output turns low with the magnetic south pole on the branded side of the package and turns high with the magnetic north pole on the branded side. The output does not change if the magnetic field is removed. For changing the output state, the opposite magnetic field polarity must be applied.

For correct functioning in the application, the sensor requires both magnetic polarities (north and south) on the branded side of the package.

Magnetic Features:

- switching type: latching
- high sensitivity
- typical B_{ON}: 2.6 mT at room temperature
- typical B_{OFF}: –2.6 mT at room temperature
- operates with static magnetic fields and dynamic magnetic fields up to 10 kHz
- typical temperature coefficient of magnetic switching points is –1000 ppm/K

Applications

The HAL 502 is the optimal sensor for all applications with alternating magnetic signals and weak magnetic amplitude at the sensor position such as:

- applications with large air gap or weak magnets,
- rotating speed measurement,
- commutation of brushless DC motors,
- CAM shaft sensors, and
- magnetic encoders.

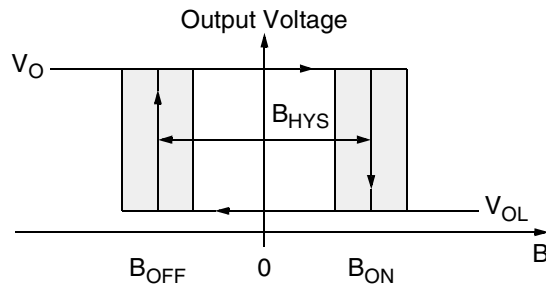

Fig. 4–5: Definition of magnetic switching points for the HAL 502

Magnetic Characteristics at T_J = –40 °C to +170 °C, V_{DD} = 3.8 V to 24 V, Typical Characteristics for V_{DD} = 12 V

Magnetic flux density values of switching points. Positive flux density values refer to the magnetic south pole at the branded side of the package.

Parameter	On point B _{ON}			Off point B _{OFF}			Hysteresis B _{HYS}			Magnetic Offset			Unit
	Min.	Typ.	Max.	Min.	Typ.	Max.	Min.	Typ.	Max.	Min.	Typ.	Max.	
T _J –40 °C	1	2.8	5	–5	–2.8	–1	4.5	5.6	7.2	–	0	–	mT
25 °C	1	2.6	4.5	–4.5	–2.6	–1	4.5	5.2	7	–1.5	0	1.5	mT
140 °C	0.9	2.4	4.3	–4.3	–2.4	–0.9	3.7	4.8	6.8	–	0	–	mT
170 °C	0.9	2.3	4.3	–4.3	–2.3	–0.9	3.5	4.6	6.8	–	0	–	mT

The hysteresis is the difference between the switching points $B_{HYS} = B_{ON} - B_{OFF}$
 The magnetic offset is the mean value of the switching points $B_{OFFSET} = (B_{ON} + B_{OFF}) / 2$

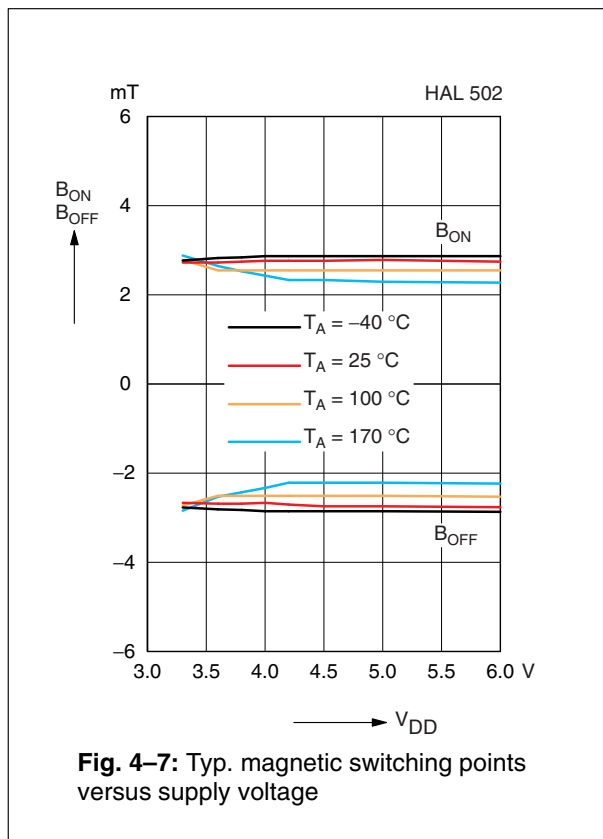
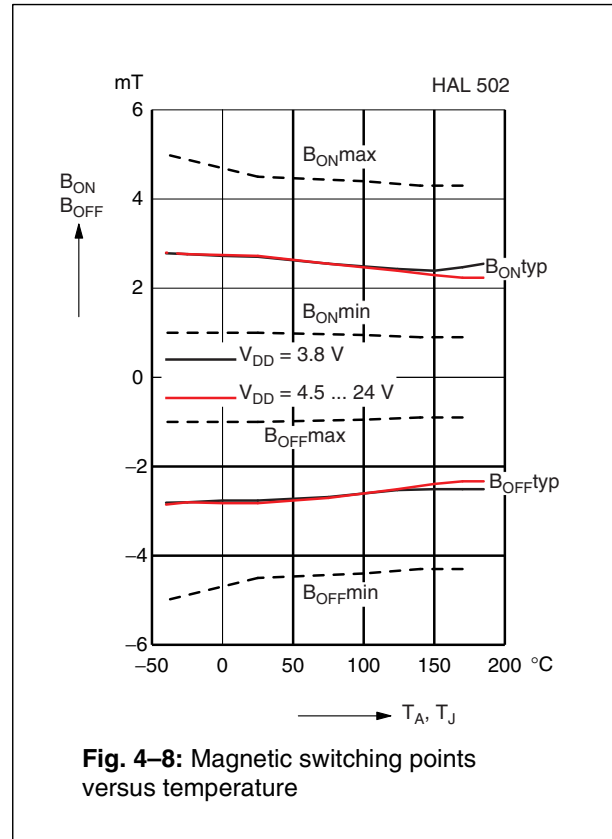
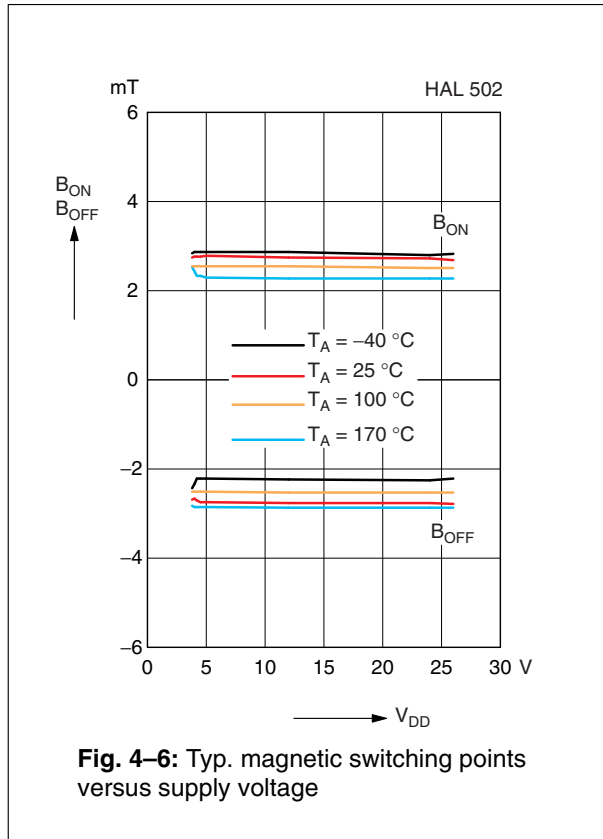

Note: In the diagram “Magnetic switching points versus temperature” the curves for: B_{ONmin} , B_{ONmax} , B_{OFFmin} , and B_{OFFmax} refer to junction temperature, whereas typical curves refer to ambient temperature.

4.3. HAL 503

The HAL 503 is a latching sensor (see Fig. 4–9).

The output turns low with the magnetic south pole on the branded side of the package and turns high with the magnetic north pole on the branded side. The output does not change if the magnetic field is removed. For changing the output state, the opposite magnetic field polarity must be applied.

For correct functioning in the application, the sensor requires both magnetic polarities (north and south) on the branded side of the package.

Magnetic Features:

- switching type: latching
- medium sensitivity
- typical B_{ON} : 7.6 mT at room temperature
- typical B_{OFF} : -7.6 mT at room temperature
- operates with static magnetic fields and dynamic magnetic fields up to 10 kHz
- typical temperature coefficient of magnetic switching points is -1000 ppm/K

Applications

The HAL 503 is the optimal sensor for applications with alternating magnetic signals such as:

- multipole magnet applications,
- rotating speed measurement,
- commutation of brushless DC motors, and
- window lifters.

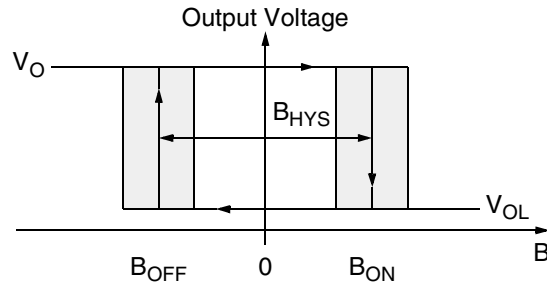

Fig. 4–9: Definition of magnetic switching points for the HAL 503

Magnetic Characteristics at $T_J = -40\text{ °C}$ to $+170\text{ °C}$, $V_{DD} = 3.8\text{ V}$ to 24 V , Typical Characteristics for $V_{DD} = 12\text{ V}$

Magnetic flux density values of switching points. Positive flux density values refer to the magnetic south pole at the branded side of the package.

Parameter	On point B_{ON}			Off point B_{OFF}			Hysteresis B_{HYS}			Magnetic Offset			Unit
	Min.	Typ.	Max.	Min.	Typ.	Max.	Min.	Typ.	Max.	Min.	Typ.	Max.	
T_J													
-40 °C	6.4	8.4	10.8	-10.8	-8.6	-6.4	14.6	17	20.6	-	-0.1	-	mT
25 °C	6	7.6	10	-10	-7.6	-6	13.6	15.2	18	-1.5	0	1.5	mT
140 °C	4.4	6.7	9.2	-9.2	-6.4	-4.4	11.5	13.1	16.5	-	0.1	-	mT
170 °C	4	6.4	8.9	-8.9	-6	-4	11	12.4	16	-	0.2	-	mT

The hysteresis is the difference between the switching points $B_{HYS} = B_{ON} - B_{OFF}$
 The magnetic offset is the mean value of the switching points $B_{OFFSET} = (B_{ON} + B_{OFF}) / 2$

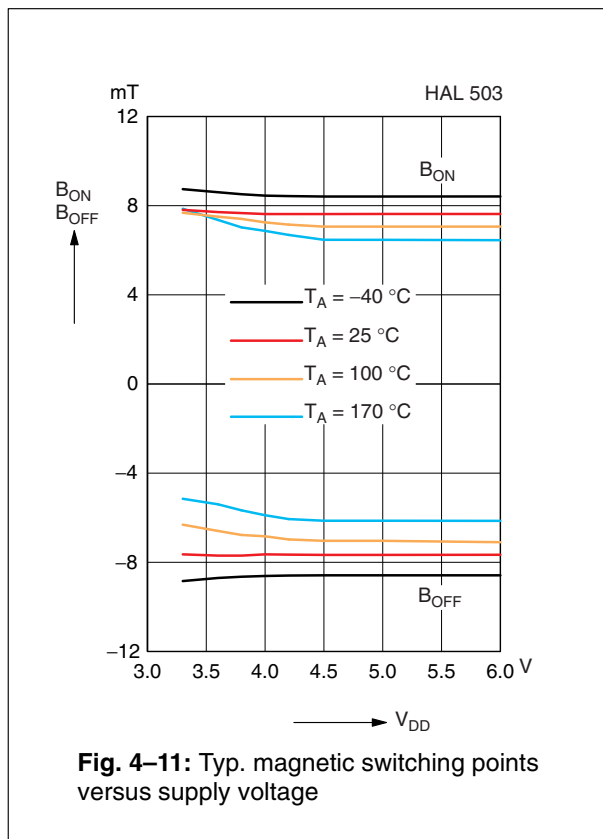
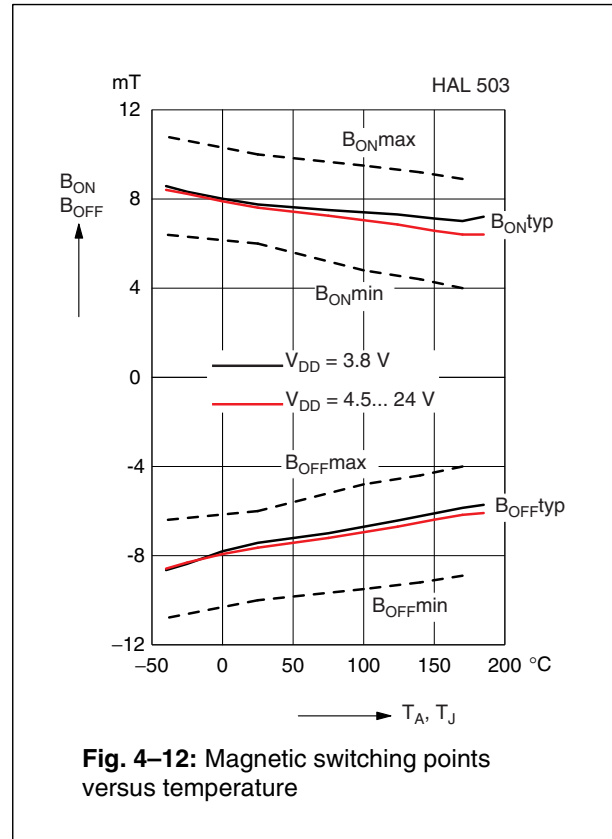
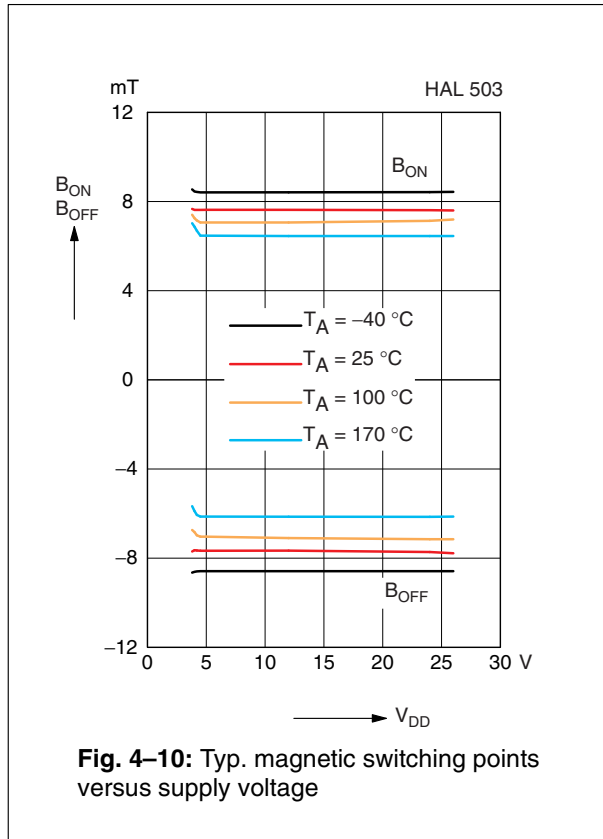

Note: In the diagram “Magnetic switching points versus ambient temperature” the curves for: B_{ONmin} , B_{ONmax} , B_{OFFmin} , and B_{OFFmax} refer to junction temperature, whereas typical curves refer to ambient temperature.

4.4. HAL 504

The HAL 504 is a unipolar switching sensor (see Fig. 4–13).

The output turns low with the magnetic south pole on the branded side of the package and turns high if the magnetic field is removed. The sensor does not respond to the magnetic north pole on the branded side.

For correct functioning in the application, the sensor requires only the magnetic south pole on the branded side of the package.

Magnetic Features:

- switching type: unipolar,
- medium sensitivity
- typical B_{ON} : 12 mT at room temperature
- typical B_{OFF} : 7 mT at room temperature
- typical temperature coefficient of magnetic switching points is -1000 ppm/K
- operates with static magnetic fields and dynamic magnetic fields up to 10 kHz.

Applications

The HAL 504 is the optimal sensor for applications with one magnetic polarity such as:

- solid state switches,
- contactless solution to replace microswitches,
- position and end-point detection, and
- rotating speed measurement.

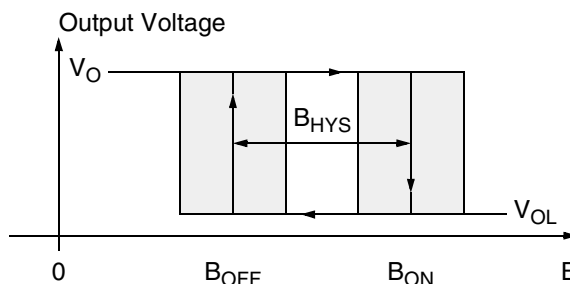

Fig. 4–13: Definition of magnetic switching points for the HAL 504

Magnetic Characteristics at $T_J = -40\text{ °C}$ to $+170\text{ °C}$, $V_{DD} = 3.8\text{ V}$ to 24 V , Typical Characteristics for $V_{DD} = 12\text{ V}$

Magnetic flux density values of switching points.

Positive flux density values refer to the magnetic south pole at the branded side of the package.

Parameter T_J	On point B_{ON}			Off point B_{OFF}			Hysteresis B_{HYS}			Magnetic Offset			Unit
	Min.	Typ.	Max.	Min.	Typ.	Max.	Min.	Typ.	Max.	Min.	Typ.	Max.	
-40 °C	10.3	13	15.7	5.3	7.5	9.6	4.4	5.5	6.5	–	10.2	–	mT
25 °C	9.5	12	14.5	5	7	9	4	5	6.5	7.2	9.5	11.8	mT
140 °C	8.7	10.6	13.9	4.4	6.1	8.6	3.4	4.5	6.4	–	8.4	–	mT
170 °C	8.5	10.2	13.7	4.2	5.9	8.5	3.2	4.3	6.4	–	8	–	mT

The hysteresis is the difference between the switching points $B_{HYS} = B_{ON} - B_{OFF}$
 The magnetic offset is the mean value of the switching points $B_{OFFSET} = (B_{ON} + B_{OFF}) / 2$

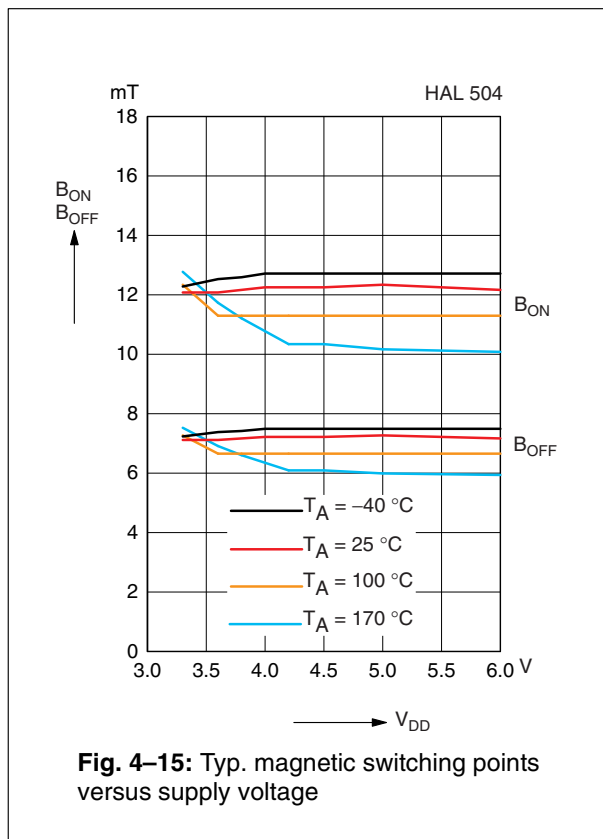
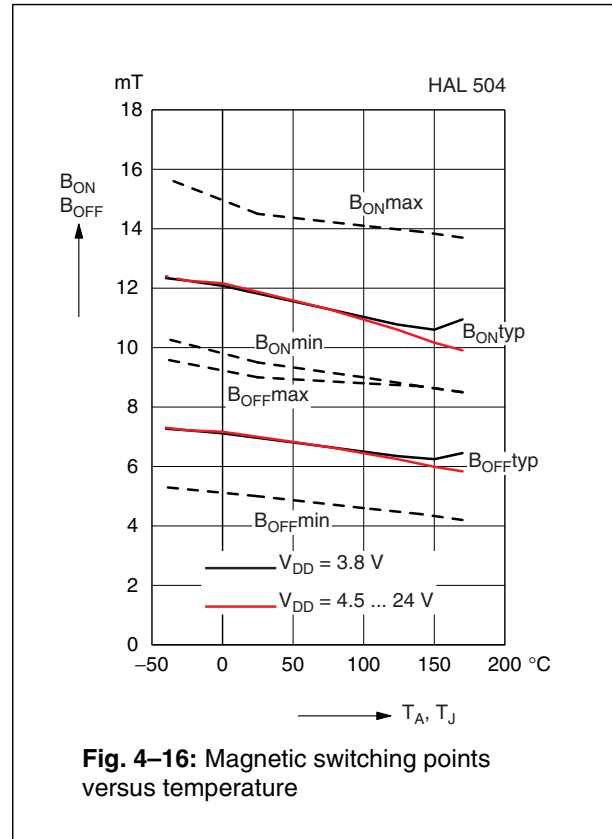
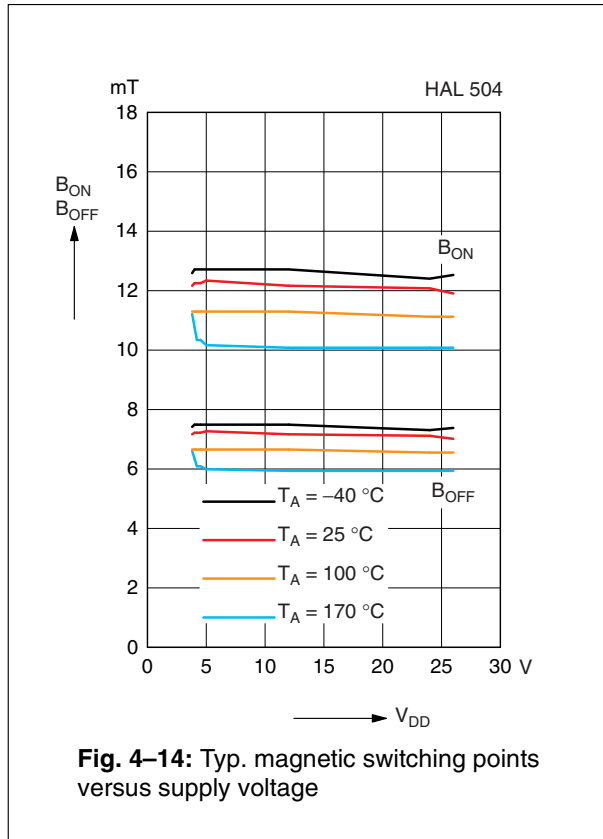

Note: In the diagram “Magnetic switching points versus temperature” the curves for: B_{ONmin} , B_{ONmax} , B_{OFFmin} , and B_{OFFmax} refer to junction temperature, whereas typical curves refer to ambient temperature.

4.5. HAL 505

The HAL 505 is a latching sensor (see Fig. 4–17).

The output turns low with the magnetic south pole on the branded side of the package and turns high with the magnetic north pole on the branded side. The output does not change if the magnetic field is removed. For changing the output state, the opposite magnetic field polarity must be applied.

For correct functioning in the application, the sensor requires both magnetic polarities (north and south) on the branded side of the package.

Magnetic Features:

- switching type: latching,
- low sensitivity
- typical B_{ON} : 13.5 mT at room temperature
- typical B_{OFF} : -13.5 mT at room temperature
- operates with static magnetic fields and dynamic magnetic fields up to 10 kHz
- typical temperature coefficient of magnetic switching points is -1000 ppm/K

Applications

The HAL 505 is the optimal sensor for applications with alternating magnetic signals such as:

- multipole magnet applications,
- rotating speed measurement,
- commutation of brushless DC motors, and
- window lifters.

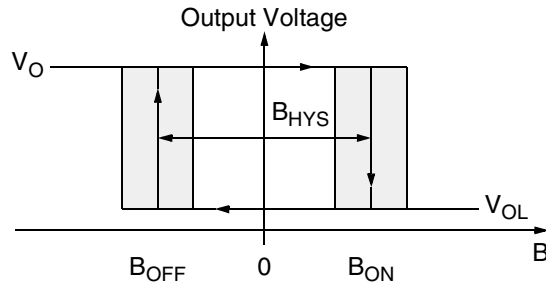

Fig. 4–17: Definition of magnetic switching points for the HAL 505

Magnetic Characteristics at $T_J = -40\text{ °C}$ to $+170\text{ °C}$, $V_{DD} = 3.8\text{ V}$ to 24 V , Typical Characteristics for $V_{DD} = 12\text{ V}$

Magnetic flux density values of switching points.

Positive flux density values refer to the magnetic south pole at the branded side of the package.

Parameter	On point B_{ON}			Off point B_{OFF}			Hysteresis B_{HYS}			Magnetic Offset			Unit
	Min.	Typ.	Max.	Min.	Typ.	Max.	Min.	Typ.	Max.	Min.	Typ.	Max.	
T_J													
-40 °C	11.8	15	18.3	-18.3	-15	-11.8	26	30	34	-	0	-	mT
25 °C	11	13.5	17	-17	-13.5	-11	24	27	32	-1.5	0	1.5	mT
140 °C	9.7	12	16.3	-16.3	-12	-9.7	21	24.2	31.3	-	0	-	mT
170 °C	9.4	11.7	16.1	-16.1	-11.7	-9.4	20	23.4	31.3	-	0	-	mT

The hysteresis is the difference between the switching points $B_{HYS} = B_{ON} - B_{OFF}$

The magnetic offset is the mean value of the switching points $B_{OFFSET} = (B_{ON} + B_{OFF}) / 2$

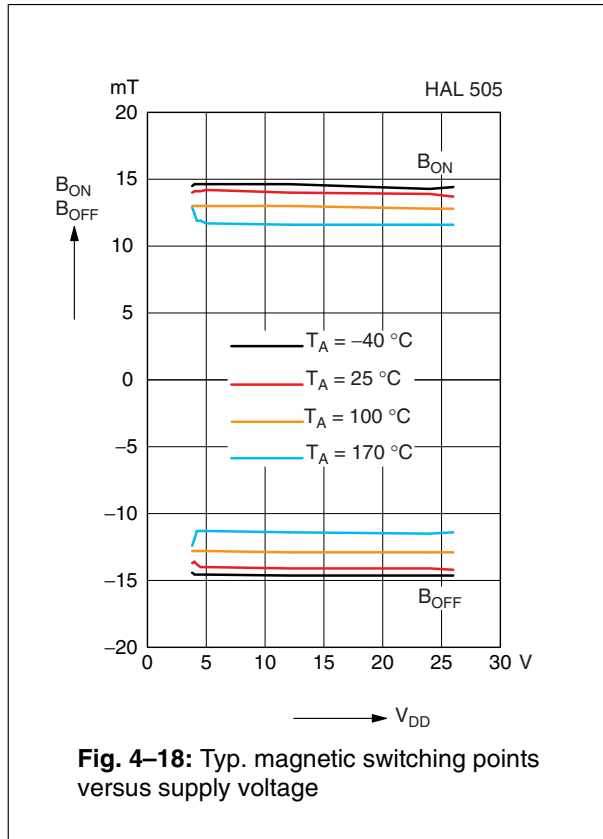

Fig. 4-18: Typ. magnetic switching points versus supply voltage

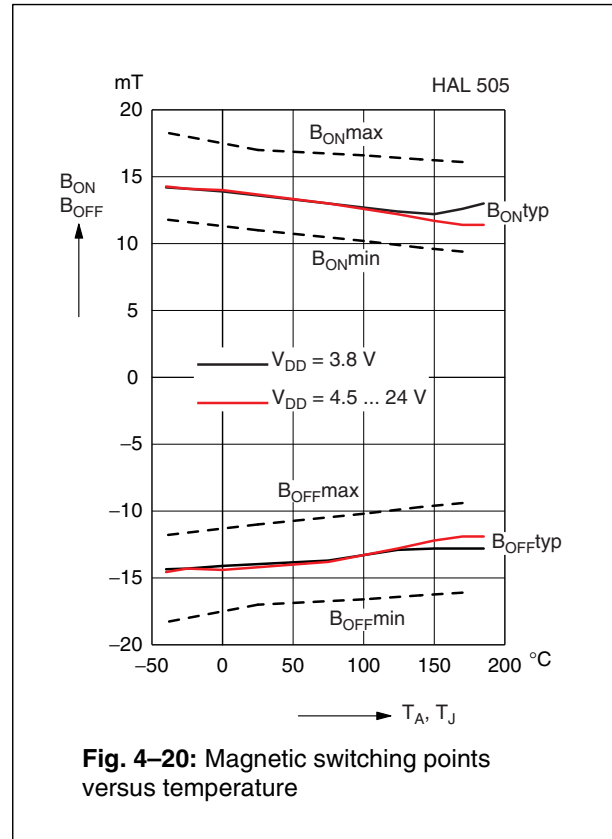

Fig. 4-20: Magnetic switching points versus temperature

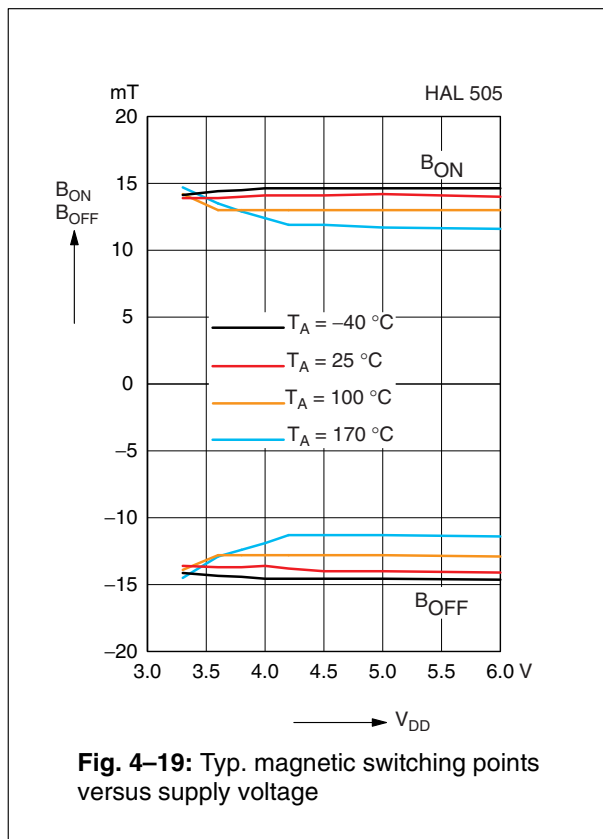

Fig. 4-19: Typ. magnetic switching points versus supply voltage

Note: In the diagram “Magnetic switching points versus ambient temperature” the curves for: B_{ONmin} , B_{ONmax} , B_{OFFmin} , and B_{OFFmax} refer to junction temperature, whereas typical curves refer to ambient temperature.

4.6. HAL 506

The HAL 506 is the most sensitive unipolar switching sensor of this family (see Fig. 4–21).

The output turns low with the magnetic south pole on the branded side of the package and turns high if the magnetic field is removed. The sensor does not respond to the magnetic north pole on the branded side.

For correct functioning in the application, the sensor requires only the magnetic south pole on the branded side of the package.

In the HAL 5xx family, the HAL 516 is a sensor with the same magnetic characteristics but with an inverted output characteristic.

Magnetic Features:

- switching type: unipolar,
- high sensitivity
- typical B_{ON} : 5.5 mT at room temperature
- typical B_{OFF} : 3.5 mT at room temperature
- operates with static magnetic fields and dynamic magnetic fields up to 10 kHz
- typical temperature coefficient of magnetic switching points is -1000 ppm/K

Applications

The HAL 506 is the optimal sensor for all applications with one magnetic polarity and weak magnetic amplitude at the sensor position such as:

- applications with large air gap or weak magnets,
- solid state switches,
- contactless solution to replace microswitches,
- position and end point detection, and
- rotating speed measurement.

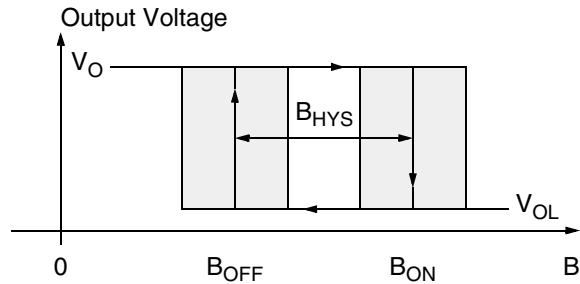

Fig. 4–21: Definition of magnetic switching points for the HAL 506

Magnetic Characteristics at $T_J = -40\text{ °C}$ to $+170\text{ °C}$, $V_{DD} = 3.8\text{ V}$ to 24 V , Typical Characteristics for $V_{DD} = 12\text{ V}$

Magnetic flux density values of switching points.

Positive flux density values refer to the magnetic south pole at the branded side of the package.

Parameter	On point B_{ON}			Off point B_{OFF}			Hysteresis B_{HYS}			Magnetic Offset			Unit
	Min.	Typ.	Max.	Min.	Typ.	Max.	Min.	Typ.	Max.	Min.	Typ.	Max.	
T_J													
-40 °C	4.3	5.9	7.7	2.1	3.8	5.4	1.6	2.1	2.8	–	4.8	–	mT
25 °C	3.8	5.5	7.2	2	3.5	5	1.5	2	2.7	3.8	4.5	6.2	mT
140 °C	3.4	4.8	6.9	1.8	3.1	5.1	1	1.7	2.6	–	4	–	mT
170 °C	3.2	4.6	6.8	1.7	3	5.2	0.9	1.6	2.6	–	3.8	–	mT

The hysteresis is the difference between the switching points $B_{HYS} = B_{ON} - B_{OFF}$

The magnetic offset is the mean value of the switching points $B_{OFFSET} = (B_{ON} + B_{OFF}) / 2$

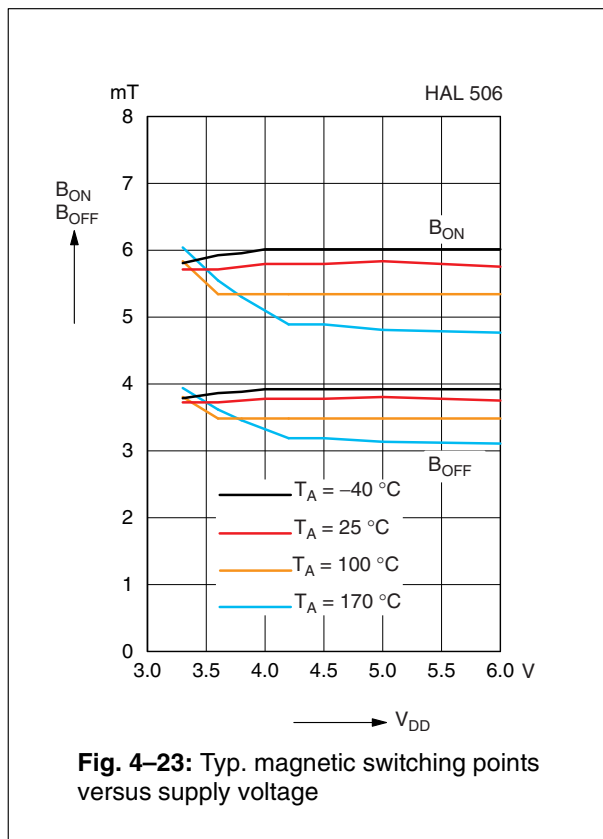
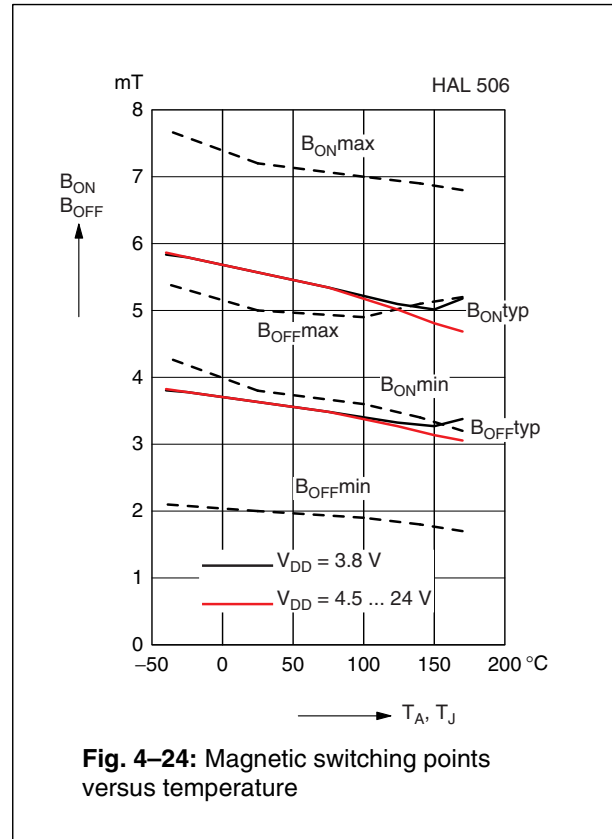
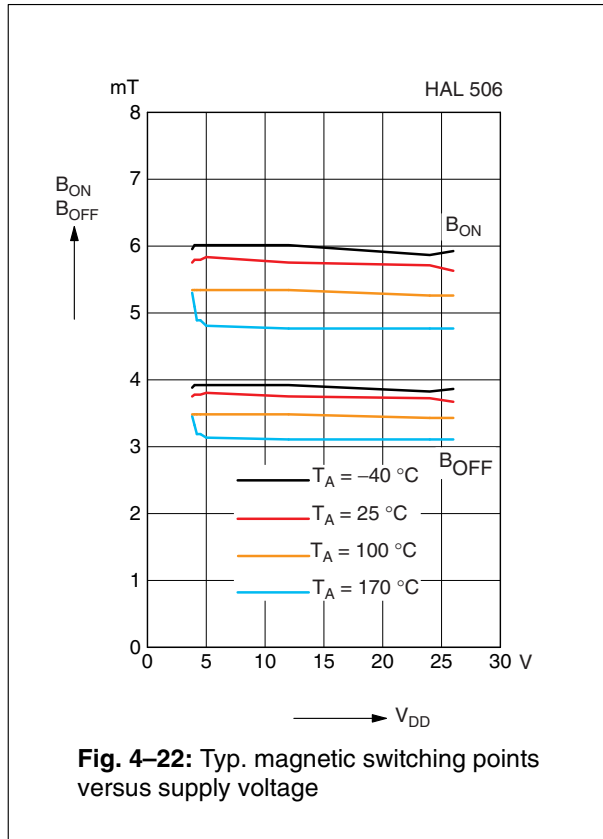

Note: In the diagram “Magnetic switching points versus temperature” the curves for: B_{ONmin} , B_{ONmax} , B_{OFFmin} , and B_{OFFmax} refer to junction temperature, whereas typical curves refer to ambient temperature.

4.7. HAL 507

The HAL 507 is a unipolar switching sensor (see Fig. 4–25).

The output turns low with the magnetic south pole on the branded side of the package and turns high if the magnetic field is removed. The sensor does not respond to the magnetic north pole on the branded side.

For correct functioning in the application, the sensor requires only the magnetic south pole on the branded side of the package.

Magnetic Features:

- switching type: unipolar
- medium sensitivity
- typical B_{ON} : 18.3 mT at room temperature
- typical B_{OFF} : 16.2 mT at room temperature
- operates with static magnetic fields and dynamic magnetic fields up to 10 kHz
- typical temperature coefficient of magnetic switching points is -1700 ppm/K

Applications

The HAL 507 is the optimal sensor for applications with one magnetic polarity such as:

- solid state switches,
- contactless solution to replace micro switches,
- position and end point detection, and
- rotating speed measurement.

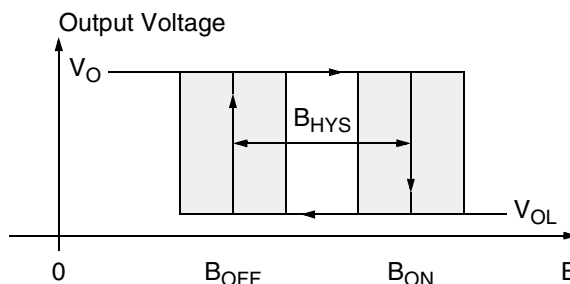

Fig. 4–25: Definition of magnetic switching points for the HAL 507

Magnetic Characteristics at $T_J = -40\text{ °C}$ to $+170\text{ °C}$, $V_{DD} = 3.8\text{ V}$ to 24 V , Typical Characteristics for $V_{DD} = 12\text{ V}$

Magnetic flux density values of switching points.

Positive flux density values refer to the magnetic south pole at the branded side of the package.

Parameter	On point B_{ON}			Off point B_{OFF}			Hysteresis B_{HYS}			Magnetic Offset			Unit
	Min.	Typ.	Max.	Min.	Typ.	Max.	Min.	Typ.	Max.	Min.	Typ.	Max.	
T_J													
-40 °C	15.5	19.6	22.5	14.0	17.1	21.5	1.6	2.5	5.2	–	18.3	–	mT
25 °C	15.0	18.3	20.7	13.5	16.2	19.0	1.5	2.1	2.7	–	17.2	–	mT
140 °C	11.5	14.8	20.2	10.0	13.2	18.2	1.0	1.6	2.6	–	14	–	mT
170 °C	10.5	13.7	20.0	9.0	12.3	18.0	0.8	1.4	2.4	–	13	–	mT

The hysteresis is the difference between the switching points $B_{HYS} = B_{ON} - B_{OFF}$

The magnetic offset is the mean value of the switching points $B_{OFFSET} = (B_{ON} + B_{OFF}) / 2$

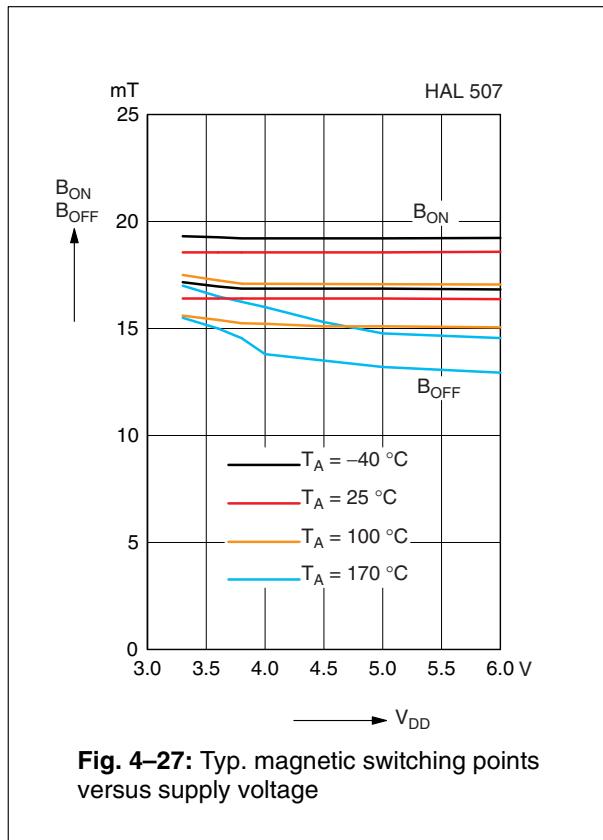
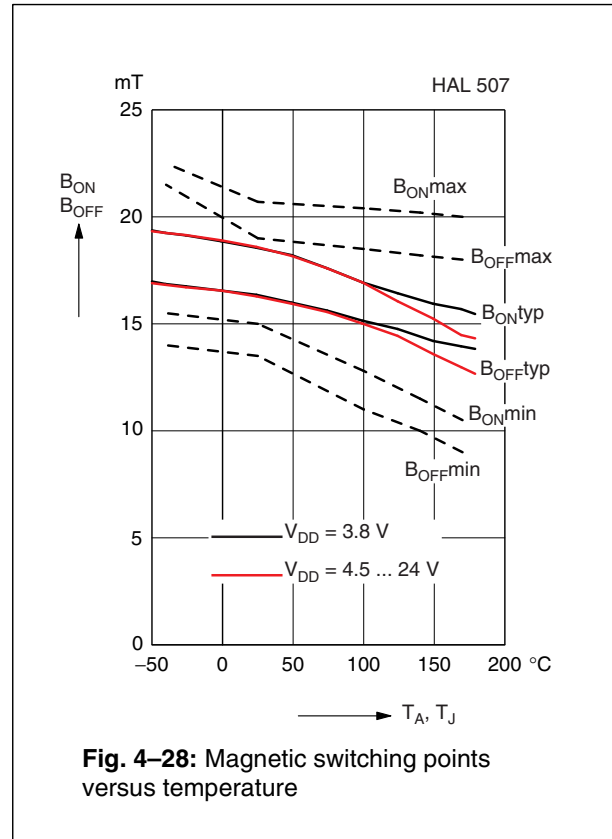
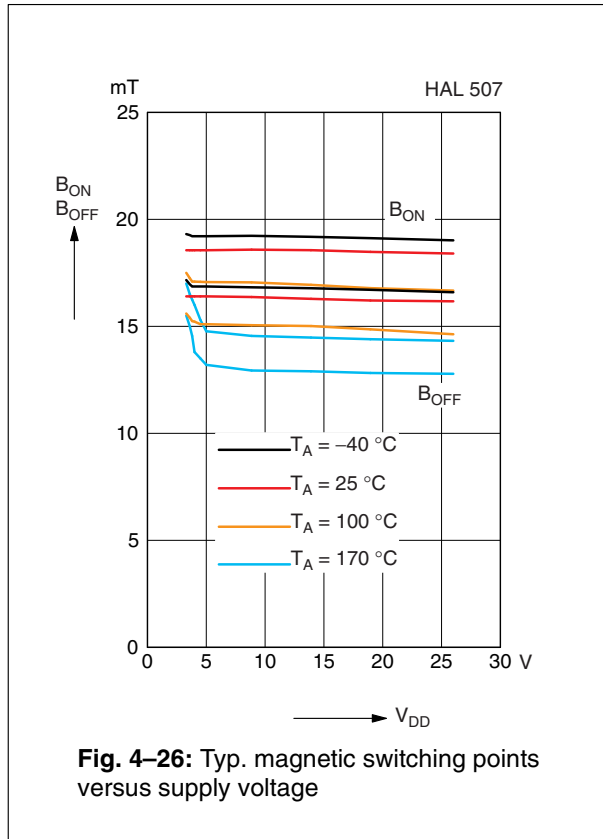

Note: In the diagram “Magnetic switching points versus ambient temperature” the curves for: B_{ONmin} , B_{ONmax} , B_{OFFmin} , and B_{OFFmax} refer to junction temperature, whereas typical curves refer to ambient temperature.

4.8. HAL 508

The HAL 508 is a unipolar switching sensor (see Fig. 4–29).

The output turns low with the magnetic south pole on the branded side of the package and turns high if the magnetic field is removed. The sensor does not respond to the magnetic north pole on the branded side.

For correct functioning in the application, the sensor requires only the magnetic south pole on the branded side of the package.

Magnetic Features:

- switching type: unipolar,
- medium sensitivity
- typical B_{ON} : 18 mT at room temperature
- typical B_{OFF} : 16 mT at room temperature
- operates with static magnetic fields and dynamic magnetic fields up to 10 kHz
- typical temperature coefficient of magnetic switching points is -1000 ppm/K

Applications

The HAL 508 is the optimal sensor for applications with one magnetic polarity such as:

- solid state switches,
- contactless solution to replace microswitches,
- position and end-point detection, and
- rotating speed measurement.

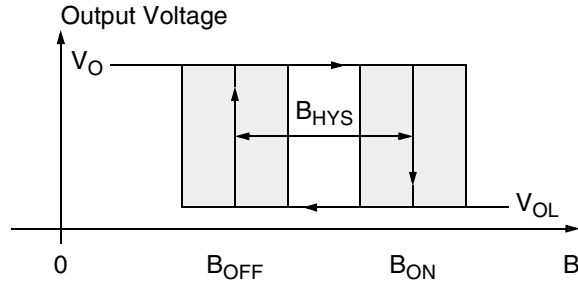

Fig. 4–29: Definition of magnetic switching points for the HAL 508

Magnetic Characteristics at $T_J = -40\text{ °C}$ to $+170\text{ °C}$, $V_{DD} = 3.8\text{ V}$ to 24 V , Typical Characteristics for $V_{DD} = 12\text{ V}$

Magnetic flux density values of switching points.

Positive flux density values refer to the magnetic south pole at the branded side of the package.

Parameter	On point B_{ON}			Off point B_{OFF}			Hysteresis B_{HYS}			Magnetic Offset			Unit
	Min.	Typ.	Max.	Min.	Typ.	Max.	Min.	Typ.	Max.	Min.	Typ.	Max.	
T_J													
-40 °C	15.5	19	21.9	14	16.7	20	1.6	2.3	2.8	-	17.8	-	mT
25 °C	15	18	20.7	13.5	16	19	1.5	2	2.7	14	17	20	mT
140 °C	13.2	15.8	20.2	11.9	14.1	18.5	1.1	1.7	2.6	-	15	-	mT
170 °C	12.7	15.3	20	11.4	13.6	18.3	1	1.7	2.6	-	14.4	-	mT

The hysteresis is the difference between the switching points $B_{HYS} = B_{ON} - B_{OFF}$
 The magnetic offset is the mean value of the switching points $B_{OFFSET} = (B_{ON} + B_{OFF}) / 2$

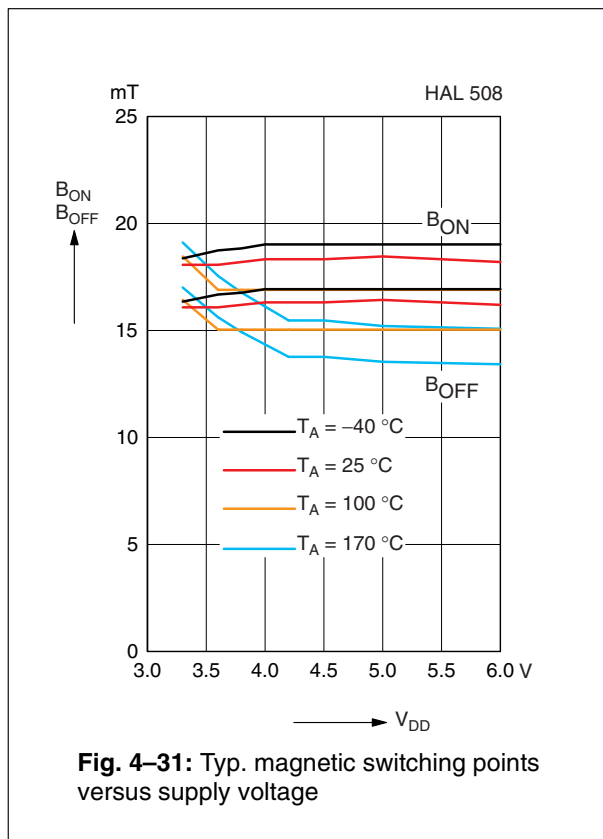
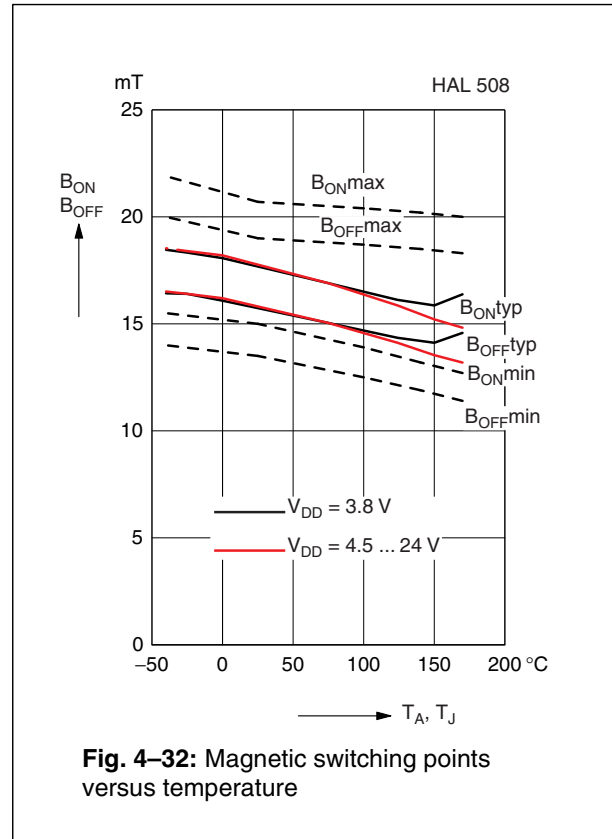
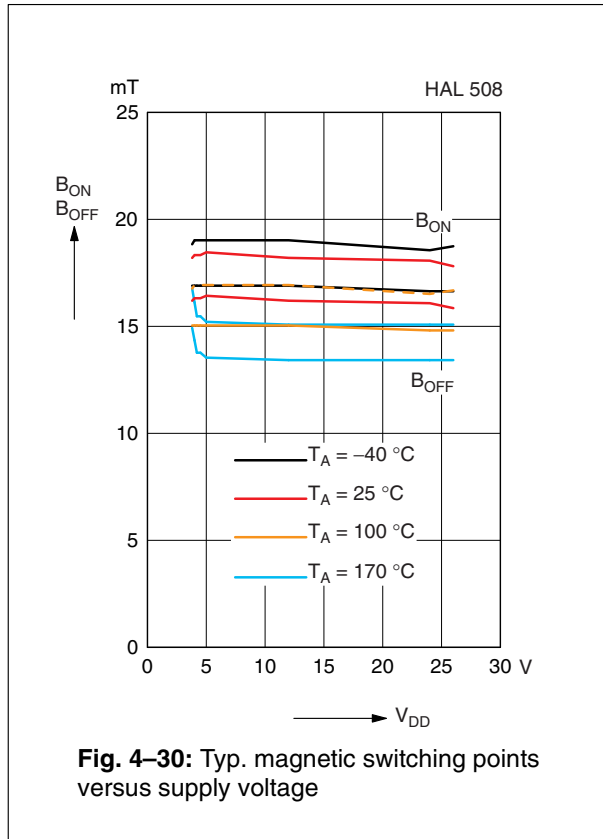

Note: In the diagram “Magnetic switching points versus temperature” the curves for: B_{ONmin} , B_{ONmax} , B_{OFFmin} , and B_{OFFmax} refer to junction temperature, whereas typical curves refer to ambient temperature.

4.9. HAL 509

The HAL 509 is a unipolar switching sensor (see Fig. 4–33).

The output turns low with the magnetic south pole on the branded side of the package and turns high if the magnetic field is removed. The sensor does not respond to the magnetic north pole on the branded side.

For correct functioning in the application, the sensor requires only the magnetic south pole on the branded side of the package.

Magnetic Features:

- switching type: unipolar,
- low sensitivity
- typical B_{ON} : 26.8 mT at room temperature
- typical B_{OFF} : 23.2 mT at room temperature
- operates with static magnetic fields and dynamic magnetic fields up to 10 kHz
- typical temperature coefficient of magnetic switching points is -300 ppm/K

Applications

The HAL 509 is the optimal sensor for applications with one magnetic polarity and strong magnetic fields at the sensor position such as:

- solid state switches,
- contactless solution to replace microswitches,
- position and end-point detection, and
- rotating speed measurement.

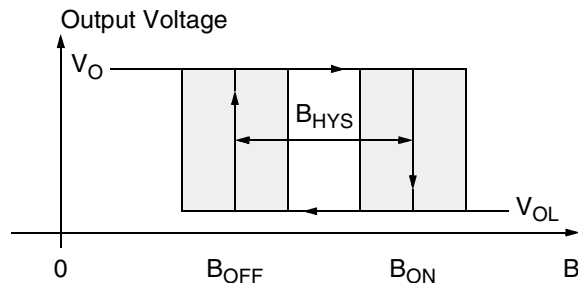

Fig. 4–33: Definition of magnetic switching points for the HAL 509

Magnetic Characteristics at $T_J = -40\text{ °C}$ to $+170\text{ °C}$, $V_{DD} = 3.8\text{ V}$ to 24 V , Typical Characteristics for $V_{DD} = 12\text{ V}$

Magnetic flux density values of switching points. Positive flux density values refer to the magnetic south pole at the branded side of the package.

Parameter	On point B_{ON}			Off point B_{OFF}			Hysteresis B_{HYS}			Magnetic Offset			Unit
	Min.	Typ.	Max.	Min.	Typ.	Max.	Min.	Typ.	Max.	Min.	Typ.	Max.	
T_J													
-40 °C	23.1	27.4	31.1	19.9	23.8	27.2	2.9	3.6	3.9	–	25.6	–	mT
25 °C	23.1	26.8	30.4	19.9	23.2	26.6	2.8	3.5	3.9	21.5	25	28.5	mT
140 °C	21.7	25.7	29.2	18.6	22.4	25.6	2.6	3.3	3.8	–	24	–	mT
170 °C	21.3	25.4	28.9	18.3	22.1	25.3	2.5	3.3	3.8	–	23.7	–	mT

The hysteresis is the difference between the switching points $B_{HYS} = B_{ON} - B_{OFF}$
 The magnetic offset is the mean value of the switching points $B_{OFFSET} = (B_{ON} + B_{OFF}) / 2$

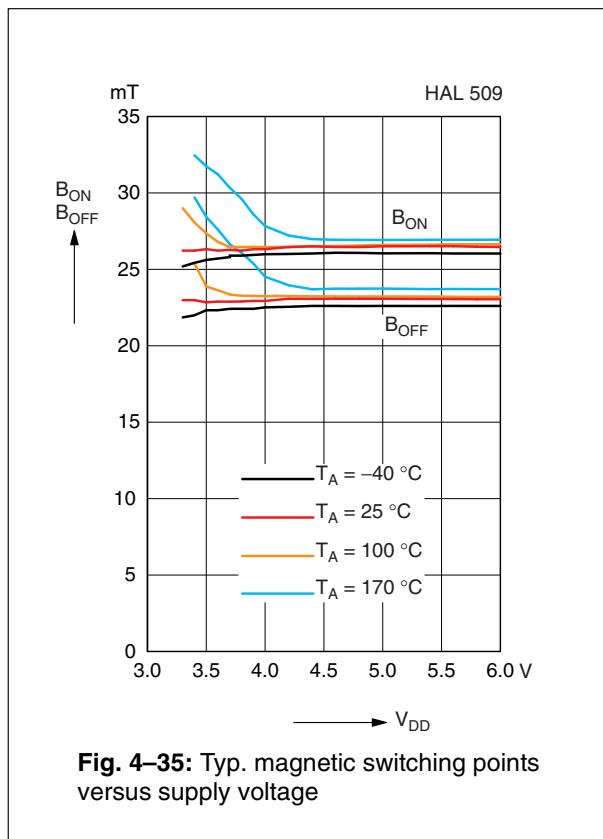
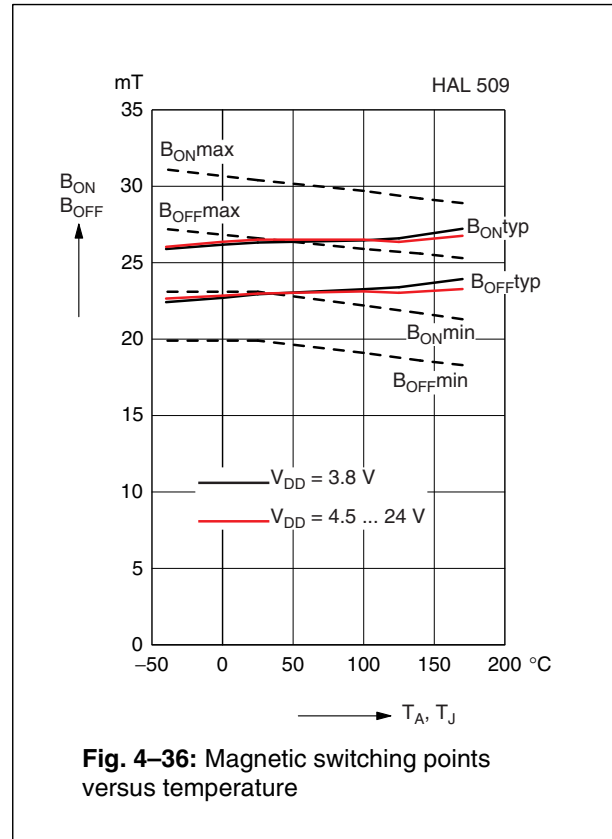
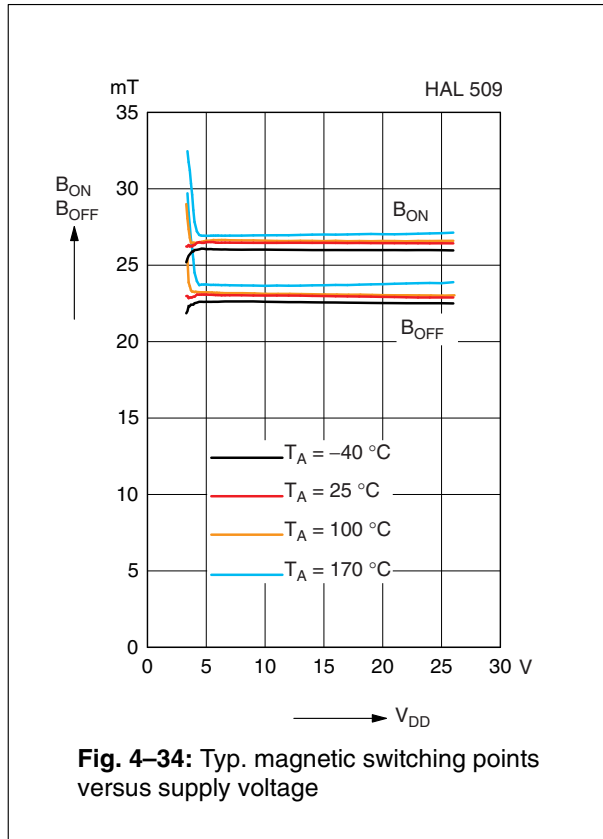

Note: In the diagram “Magnetic switching points versus temperature” the curves for: B_{ONmin} , B_{ONmax} , B_{OFFmin} , and B_{OFFmax} refer to junction temperature, whereas typical curves refer to ambient temperature.

4.10. HAL 516

The HAL 516 is the most sensitive unipolar switching sensor with an inverted output of this family (see Fig. 4–37).

The output turns high with the magnetic south pole on the branded side of the package and turns low if the magnetic field is removed. The sensor does not respond to the magnetic north pole on the branded side.

For correct functioning in the application, the sensor requires only the magnetic south pole on the branded side of the package.

In the HAL 5xx family, the HAL 506 is a sensor with the same magnetic characteristics but with a normal output characteristic.

Magnetic Features:

- switching type: unipolar inverted
- high sensitivity
- typical B_{ON} : 3.5 mT at room temperature
- typical B_{OFF} : 5.5 mT at room temperature
- operates with static magnetic fields and dynamic magnetic fields up to 10 kHz
- typical temperature coefficient of magnetic switching points is -1000 ppm/K

Applications

The HAL 516 is the optimal sensor for all applications with one magnetic polarity and weak magnetic amplitude at the sensor position where an inverted output signal is required such as:

- applications with large air gap or weak magnets,
- solid state switches,
- contactless solution to replace microswitches,
- position and end-point detection, and
- rotating speed measurement.

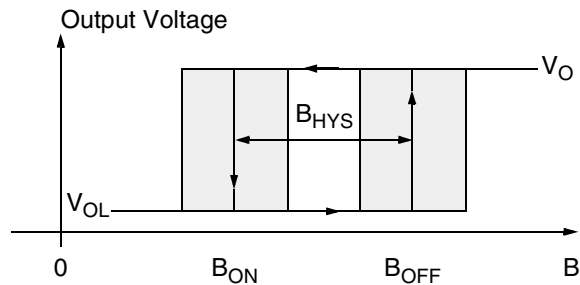

Fig. 4–37: Definition of magnetic switching points for

the HAL 516

Magnetic Characteristics at $T_J = -40\text{ °C}$ to $+170\text{ °C}$, $V_{DD} = 3.8\text{ V}$ to 24 V , Typical Characteristics for $V_{DD} = 12\text{ V}$

Magnetic flux density values of switching points. Positive flux density values refer to the magnetic south pole at the branded side of the package.

Parameter	On point B_{ON}			Off point B_{OFF}			Hysteresis B_{HYS}			Magnetic Offset			Unit
	Min.	Typ.	Max.	Min.	Typ.	Max.	Min.	Typ.	Max.	Min.	Typ.	Max.	
T_J													
-40 °C	2.1	3.8	5.4	4.3	5.9	7.7	1.6	2.1	2.8	-	4.8	-	mT
25 °C	2	3.5	5	3.8	5.5	7.2	1.5	2	2.7	3.8	4.5	6.2	mT
140 °C	1.8	3.1	5.1	3.4	4.8	6.9	1	1.7	2.6	-	4	-	mT
170 °C	1.7	3	5.2	3.2	4.6	6.8	0.9	1.6	2.6	-	3.8	-	mT

The hysteresis is the difference between the switching points $B_{HYS} = B_{ON} - B_{OFF}$
 The magnetic offset is the mean value of the switching points $B_{OFFSET} = (B_{ON} + B_{OFF}) / 2$

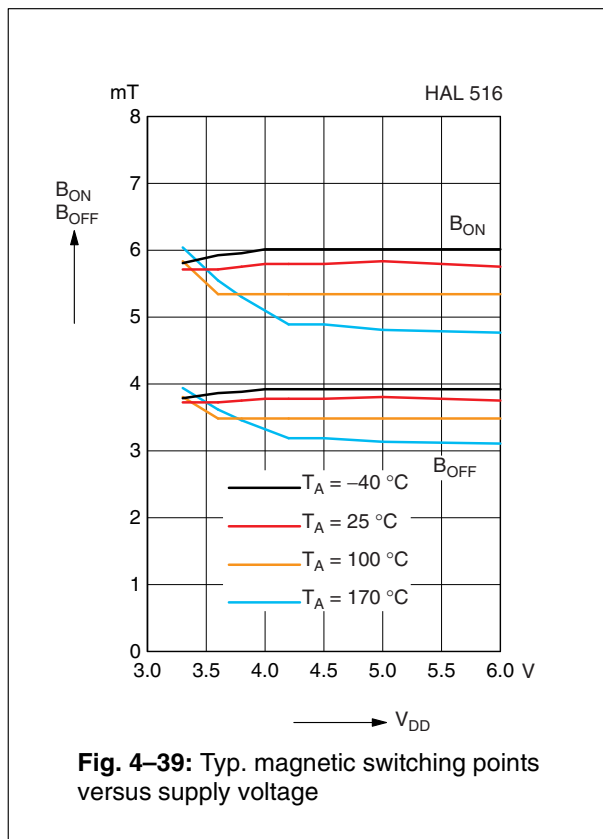
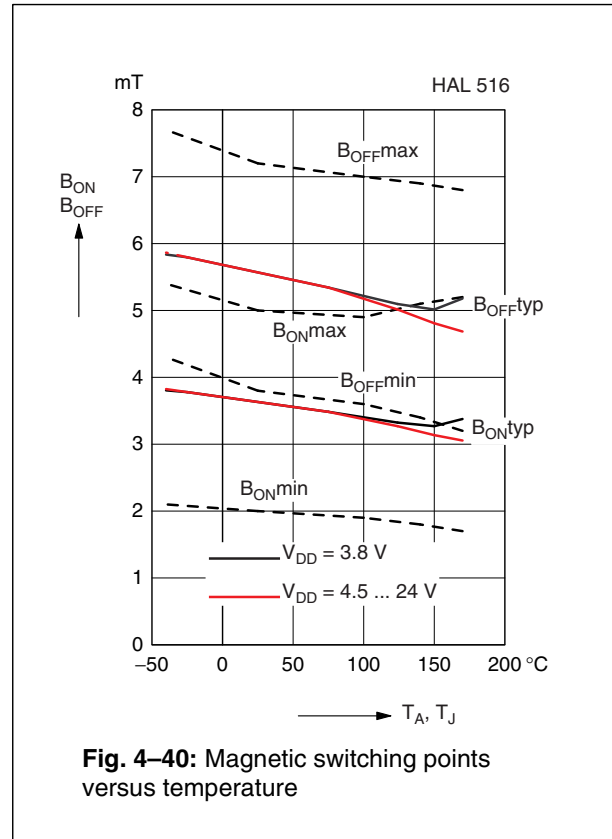
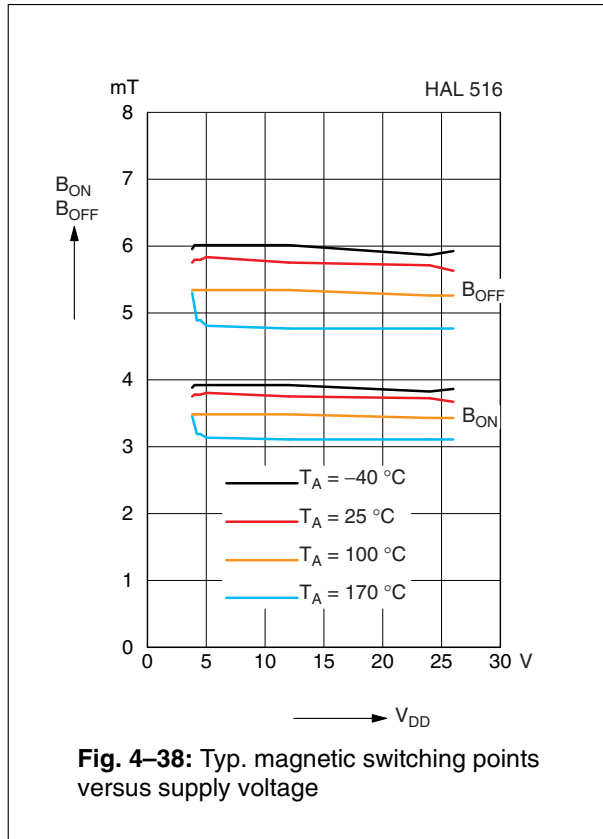

Note: In the diagram “Magnetic switching points versus temperature” the curves for: B_{ONmin} , B_{ONmax} , B_{OFFmin} , and B_{OFFmax} refer to junction temperature, whereas typical curves refer to ambient temperature.

4.11. HAL 519

The HAL 519 is a very sensitive unipolar switching sensor with an inverted output sensitive only to the magnetic north polarity (see Fig. 4–41).

The output turns high with the magnetic north pole on the branded side of the package and turns low if the magnetic field is removed. The sensor does not respond to the magnetic south pole on the branded side, the output remains low. For correct functioning in the application, the sensor requires only the magnetic north pole on the branded side of the package.

Magnetic Features:

- switching type: unipolar inverted, north sensitive
- high sensitivity
- typical B_{ON} : -3.5 mT at room temperature
- typical B_{OFF} : -5.5 mT at room temperature
- operates with static magnetic fields and dynamic magnetic fields up to 10 kHz
- typical temperature coefficient of magnetic switching points is -1000 ppm/K

Applications

The HAL 519 is the optimal sensor for all applications with the north magnetic polarity and weak magnetic amplitude at the sensor position where an inverted output signal is required such as:

- solid-state switches,
- contactless solution to replace microswitches,
- position and end-point detection, and
- rotating speed measurement.

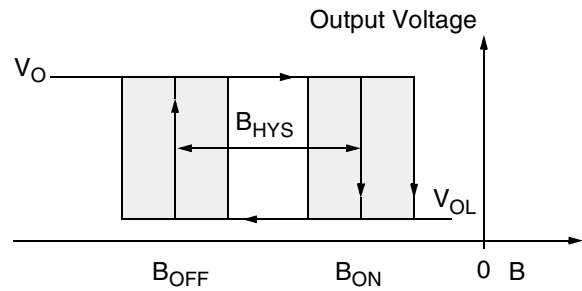

Fig. 4–41: Definition of magnetic switching points for the HAL 519

Magnetic Characteristics at $T_J = -40\text{ °C}$ to $+170\text{ °C}$, $V_{DD} = 3.8\text{ V}$ to 24 V , Typical Characteristics for $V_{DD} = 12\text{ V}$

Magnetic flux density values of switching points. Positive flux density values refer to the magnetic south pole at the branded side of the package.

Parameter	On point B_{ON}			Off point B_{OFF}			Hysteresis B_{HYS}			Magnetic Offset			Unit
	Min.	Typ.	Max.	Min.	Typ.	Max.	Min.	Typ.	Max.	Min.	Typ.	Max.	
T_J													
-40 °C	-5.4	-3.8	-2.1	-7.7	-5.9	-4.3	1.6	2.1	2.8	-	-4.8	-	mT
25 °C	-5	-3.6	-2	-7.2	-5.5	-3.8	1.5	1.9	2.7	-6.2	-4.5	-3.8	mT
140 °C	-5.1	-3.1	-1.7	-6.8	-4.8	-3.1	1	1.7	2.6	-	-4	-	mT
170 °C	-5.2	-3	-1.5	-6.8	-4.6	-2.8	0.9	1.6	2.6	-	-3.8	-	mT

The hysteresis is the difference between the switching points $B_{HYS} = B_{ON} - B_{OFF}$
 The magnetic offset is the mean value of the switching points $B_{OFFSET} = (B_{ON} + B_{OFF}) / 2$

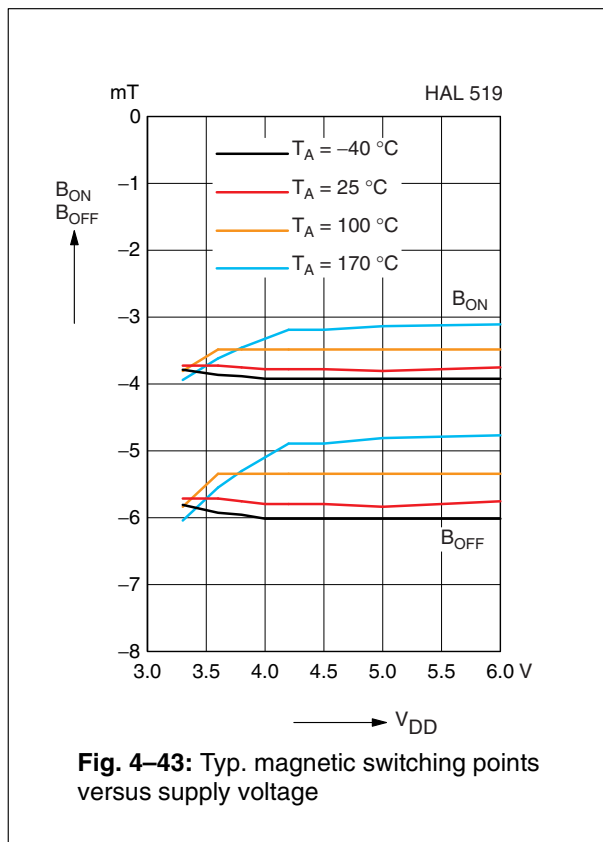
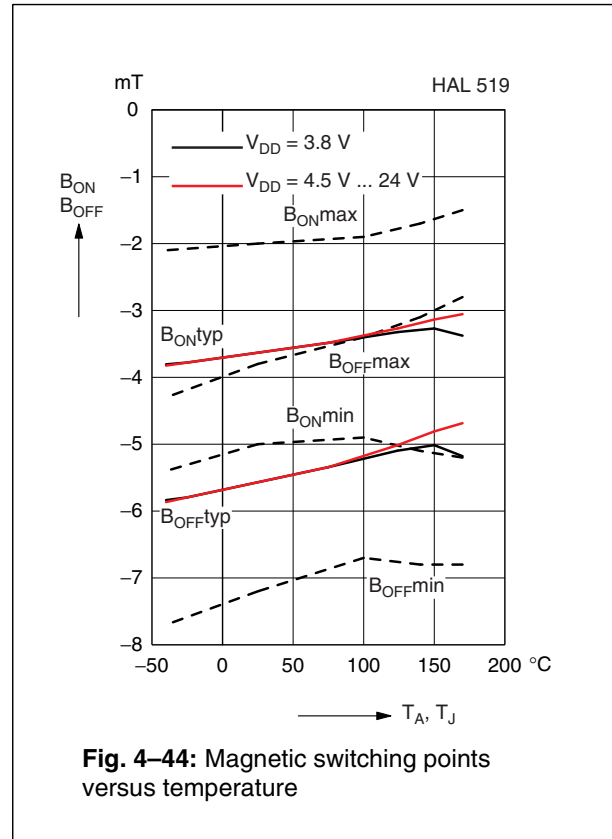
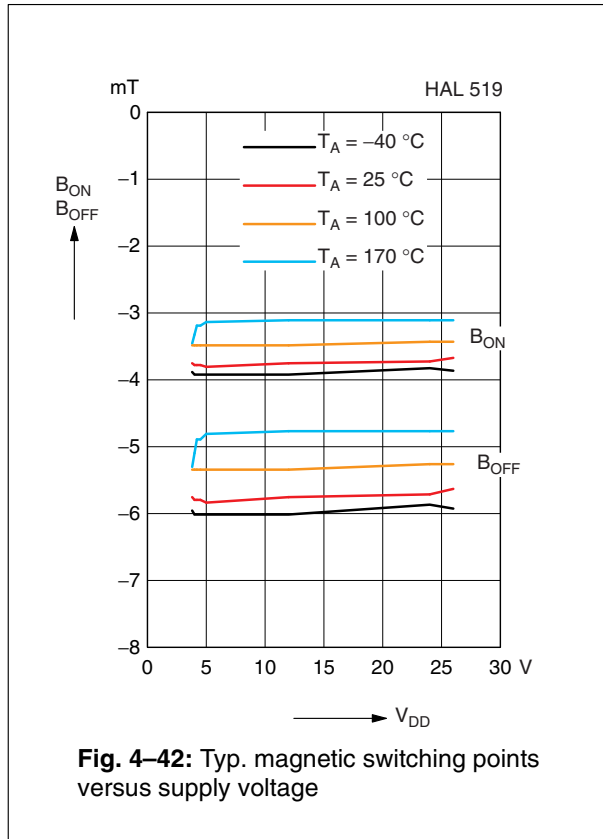

Note: In the diagram “Magnetic switching points versus temperature” the curves for: B_{ONmin} , B_{ONmax} , B_{OFFmin} , and B_{OFFmax} refer to junction temperature, whereas typical curves refer to ambient temperature.

4.12. HAL 523

The HAL 523 is the least sensitive unipolar switching sensor of this family (see Fig. 4–45).

The output turns low with the magnetic south pole on the branded side of the package and turns high if the magnetic field is removed. The sensor does not respond to the magnetic north pole on the branded side.

For correct functioning in the application, the sensor requires only the magnetic south pole on the branded side of the package.

Magnetic Features:

- switching type: unipolar,
- low sensitivity
- typical B_{ON} : 34.5 mT at room temperature
- typical B_{OFF} : 24 mT at room temperature
- operates with static magnetic fields and dynamic magnetic fields up to 10 kHz

Applications

The HAL 523 is the optimal sensor for applications with one magnetic polarity and strong magnetic fields at the sensor position such as:

- solid-state switches,
- contactless solution to replace microswitches,
- position and end-point detection, and
- rotating speed measurement.

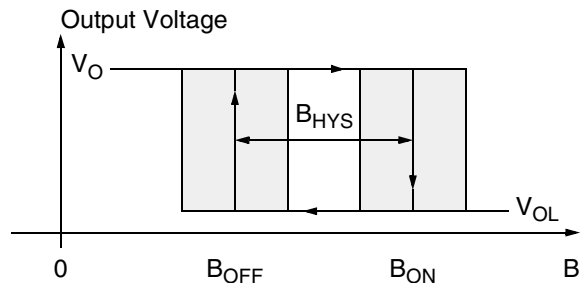

Fig. 4–45: Definition of magnetic switching points for the HAL 523

Magnetic Characteristics at $T_J = -40\text{ °C}$ to $+170\text{ °C}$, $V_{DD} = 3.8\text{ V}$ to 24 V , Typical Characteristics for $V_{DD} = 12\text{ V}$

Magnetic flux density values of switching points.

Positive flux density values refer to the magnetic south pole at the branded side of the package.

Parameter	On point B_{ON}			Off point B_{OFF}			Hysteresis B_{HYS}			Magnetic Offset			Unit
	Min.	Typ.	Max.	Min.	Typ.	Max.	Min.	Typ.	Max.	Min.	Typ.	Max.	
T_J													
-40 °C	28	34.5	42	18	24	30	7	10.5	14	–	29.3	–	mT
25 °C	28	34.5	42	18	24	30	7	10.5	14	–	29.3	–	mT
140 °C	28	34.5	42	18	24	30	7	10.5	14	–	29.3	–	mT
170 °C	28	34.5	42	18	24	30	7	10.5	14	–	29.3	–	mT

The hysteresis is the difference between the switching points $B_{HYS} = B_{ON} - B_{OFF}$
 The magnetic offset is the mean value of the switching points $B_{OFFSET} = (B_{ON} + B_{OFF}) / 2$

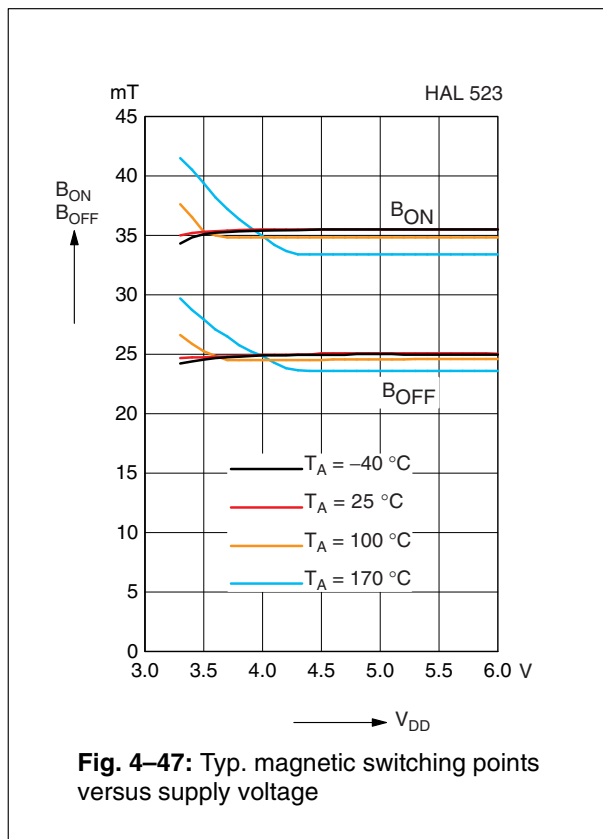
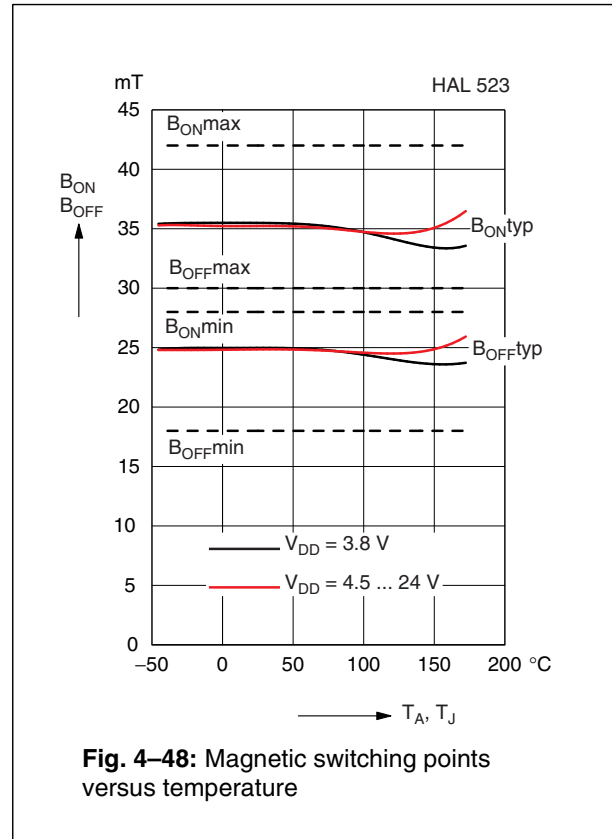
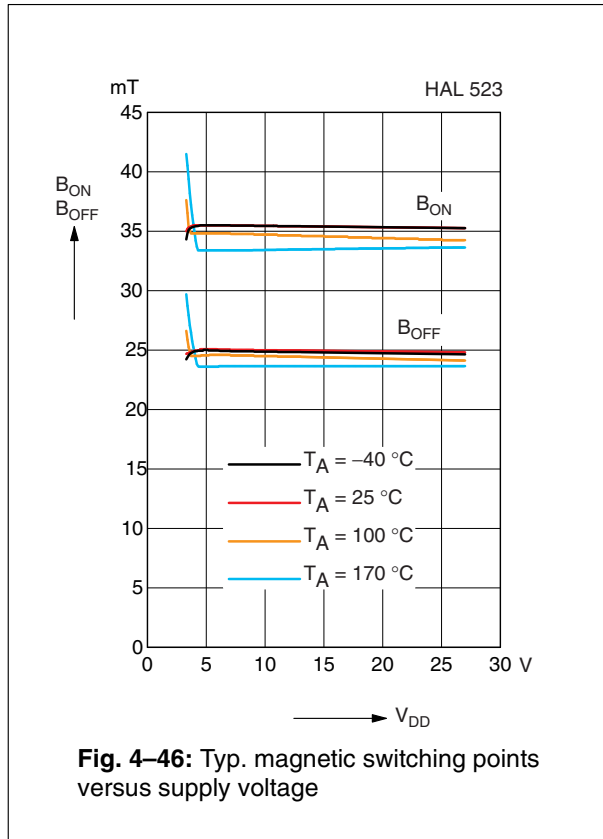

Note: In the diagram “Magnetic switching points versus temperature” the curves for: B_{ONmin} , B_{ONmax} , B_{OFFmin} , and B_{OFFmax} refer to junction temperature, whereas typical curves refer to ambient temperature.

5. Application Notes

5.1. Ambient Temperature

Due to the internal power dissipation, the temperature on the silicon chip (junction temperature T_J) is higher than the temperature outside the package (ambient temperature T_A).

$$T_J = T_A + \Delta T$$

Under static conditions and continuous operation, the following equation applies:

$$\Delta T = I_{DD} \times V_{DD} \times R_{th}$$

For all sensors, the junction temperature range T_J is specified. The maximum ambient temperature T_{Amax} can be calculated as:

$$T_{Amax} = T_{Jmax} - \Delta T$$

For typical values, use the typical parameters. For worst case calculation, use the max. parameters for I_{DD} and R_{th} , and the max. value for V_{DD} from the application.

5.2. Extended Operating Conditions

All sensors fulfil the electrical and magnetic characteristics when operated within the Recommended Operating Conditions (see page 14).

Supply Voltage Below 3.8 V

Typically, the sensors operate with supply voltages above 3 V, however, below 3.8 V some characteristics may be outside the specification.

Note: The functionality of the sensor below 3.8 V is not tested on a regular base. For special test conditions, please contact Micronas.

5.3. Start-Up Behavior

Due to the active offset compensation, the sensors have an initialization time (enable time $t_{en(O)}$) after applying the supply voltage. The parameter $t_{en(O)}$ is specified in the Electrical Characteristics (see page 15).

During the initialization time, the output state is not defined and the output can toggle. After $t_{en(O)}$, the output will be low if the applied magnetic field B is above B_{ON} . The output will be high if B is below B_{OFF} . In case of sensors with an inverted switching behavior (HAL 516 ... HAL 519), the output state will be high if $B > B_{OFF}$ and low if $B < B_{ON}$.

Note: For magnetic fields between B_{OFF} and B_{ON} , the output state of the HAL sensor will be either low or high after applying V_{DD} . In order to achieve a defined output state, the applied magnetic field must be above B_{ON} , respectively, below B_{OFF} .

5.4. EMC and ESD

For applications with disturbances on the supply line or radiated disturbances, a series resistor and a capacitor are recommended (see Fig. 5–1). The series resistor and the capacitor should be placed as closely as possible to the HAL sensor.

Applications with this arrangement passed the EMC tests according to the product standards ISO 7637.

Please contact Micronas for the detailed investigation reports with the EMC and ESD results.

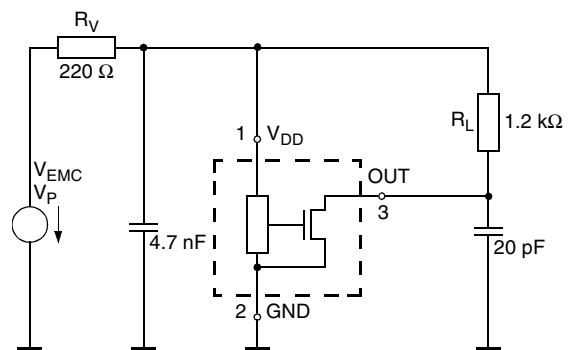

Fig. 5–1: Test circuit for EMC investigations

intentionally left vacant

6. Data Sheet History

1. Final data sheet: "HAL 501...506, 508, 509, 516... 518, Hall Effect Sensor Family, Aug. 11, 1999, 6251-485-1DS. First release of the final data sheet. Major changes to the previous edition "HAL501 ... HAL506, HAL 508", Hall Effect Sensor ICs, May 5, 1997, 6251-405-1DS:
 - additional types: HAL509, HAL516 ... HAL518
 - additional package SOT-89B
 - additional temperature range "K"
 - outline dimensions for SOT-89A and TO-92UA changed
 - absolute maximum ratings changed
 - electrical characteristics changed
 - magnetic characteristics for HAL 501, HAL 503, HAL 506, and HAL 509 changed
2. Final data sheet: "HAL 501...506, 508, 509, 516... 519, 523, Hall Effect Sensor Family", Feb. 14, 2001, 6251-485-2DS. Second release of the final data sheet. Major changes:
 - additional types: HAL519, HAL523
 - phased-out package SOT-89A removed
 - temperature range "C" removed
 - outline dimensions for SOT-89B: reduced tolerances
3. Final data sheet: "HAL 501...506, 508, 509, 516... 519, 523, Hall Effect Sensor Family", Oct. 7, 2002, 6251-485-3DS. Third release of the final data sheet. Major changes:
 - temperature range "E" removed
 - outline dimensions for TO-92UA: package diagram updated
 - absolute maximum ratings changed
 - section 3.4.1. added
 - electrical characteristics changed
 - magnetic characteristics changed
4. Final data sheet: "HAL 5xy Hall-Effect Sensor Family", Nov. 27, 2003, 6251-485-4DS (DSH000020_001EN) . Fourth release of the data sheet . Major changes:
 - new package diagrams for SOT89-1 and TO92UA-1
 - package diagram for TO92UA-2 added
 - ammpack diagrams for TO92UA-1/-2 added
5. Final data sheet : "HAL 5xy Hall-Effect Sensor Family", Dec. 4, 2008, DSH000020_002EN. Fifth release of the data sheet . Major changes:
 - Section 1.6. on page 6 "Solderability and Welding" updated
 - figures "Definition of magnetic switching points" updated for HAL508, HAL516 and HAL519
 - recommended footprint SOT89-B1 added
 - all package diagrams updated.
6. Final data sheet : "HAL 5xy Hall-Effect Sensor Family", Feb. 12, 2009, DSH000020_003EN. Sixth release of the data sheet . Minor changes:
 - Section 3.3. "Positions of Sensitive Areas" updated (parameter A4 for SOT89-B1 was added).
7. Final data sheet : "HAL 5xy Hall-Effect Sensor Family", Jan. 11. 2010, DSH000020_004EN. Seventh release of the data sheet. Major changes:
 - HAL 507 added
 - TO92UA outline dimensions updated