

Features

- Lead free
- RoHS compliant*
- Low profile
- Surface mount
- Very low forward voltage drop

Applications

- Cellular phones
- PDAs
- Desktop PCs and notebooks
- Digital cameras
- MP3 players

CD216A-B120L ~ B140 MITE Chip Diode

General Information

The markets of portable communications, computing and video equipment are challenging the semiconductor industry to develop increasingly smaller electronic components.

Bourns offers Schottky Rectifier Diodes for rectification applications in compact DO-216AA size chip package formats, which offer PCB real estate savings and are considerably smaller than competitive parts. The Schottky Barrier Rectifier Diodes offer a forward current of 1 A with a choice of repetitive peak reverse voltage of 20 V up to 40 V.

Bourns® Chip Diodes conform to JEDEC standards, are easy to handle with standard pick and place equipment and the flat configuration minimizes roll away.

Electrical Characteristics (@ T_A = 25 °C Unless Otherwise Noted)

Parameter	Symbol	CD216A-				Unit
		B120L	B120R	B130L	B140	
Forward Voltage (Max.) (I _F = 1 A)	V _F	0.45	0.53	0.38	0.55	V
Typical Junction Capacitance*	C _T	90	75	70	60	pF
Reverse Current (Max.) (at Rated V _R)	I _R	400	10	410	500	μA

* Measured at 1.0 MHz and applied reverse voltage of 4.0 V DC.

Absolute Ratings (@ T_A = 25 °C Unless Otherwise Noted)

Parameter	Symbol	CD216-				Unit
		B120L	B120R	B130L	B140	
Repetitive Peak Reverse Voltage	V _{RRM}	20	20	30	40	V
DC Blocking Voltage	V _{DC}	20	20	30	40	V
RMS Voltage	V _{RMS}	14	14	21	28	V
Average Forward Current @ T _L = 130 °C	I _O	1				A
Peak Forward Surge Current**	I _{FSM}	50	50	50	40	A
Max. Instantaneous Forward Voltage*** @ I _F = 0.1 A @ I _F = 1.0 A @ I _F = 2.0 A @ I _F = 3.0 A	V _F	0.34 0.45 0.65	0.455 0.53 0.595	0.30 0.38 0.52	0.36 0.55 0.85	V
Max. Instantaneous Reverse Current @ V _R = 40 V @ V _R = 30 V @ V _R = 20 V @ V _R = 10 V @ V _R = 5 V	I _R	0.4 0.1	0.0100 0.0010 0.0005	0.41 0.13 0.05	0.50	mA
Thermal Resistance Junction to Lead (Anode) Junction to Tab (Cathode) Junction to Ambient	R _{θJL} R _{θJTAB} R _{θJA}	35 20 250				°C/W °C/W °C/W
Storage Temperature	T _{STG}	-55 to +125				°C
Junction Temperature	T _J	-55 to +150				°C

** Surge Current 8.3 ms single phase, half sine wave, 60 Hz (JEDEC Method).

*** Pulse Test; Pulse Width = 300 μs, Duty Cycle = 2 %.

*RoHS Directive 2002/95/EC Jan 27 2003 including Annex

Specifications are subject to change without notice.

Customers should verify actual device performance in their specific applications.

CD216A-B120L ~ B140 MITE Chip Diode



Product Dimensions

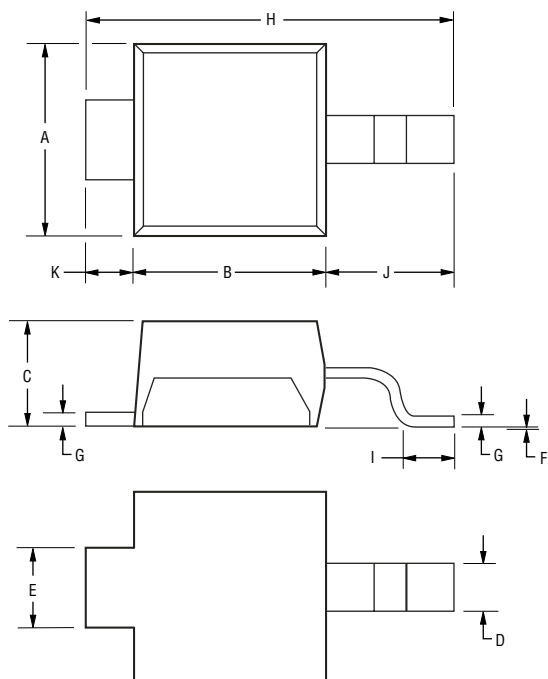

Dimension	(DO-216AA)
A	$\frac{1.75 - 2.05}{(0.069 - 0.081)}$
B	$\frac{1.80 - 2.20}{(0.071 - 0.087)}$
C	$\frac{0.95 - 1.25}{(0.037 - 0.049)}$
D	$\frac{0.42 - 0.68}{(0.017 - 0.027)}$
E	$\frac{0.70 - 1.00}{(0.028 - 0.039)}$
F	$\frac{-0.05 - +0.10}{(0.002 - 0.004)}$
G	$\frac{0.10 - 0.25}{(0.004 - 0.010)}$
H	$\frac{3.65 - 3.95}{(0.144 - 0.156)}$
I	$\frac{0.40 - 0.70}{(0.016 - 0.028)}$
J	$\frac{1.10 - 1.50}{(0.043 - 0.059)}$
K	$\frac{0.20 - 0.80}{(0.008 - 0.060)}$

DIMENSIONS: $\frac{\text{MM}}{(\text{INCHES})}$

Recommended Pad Layout

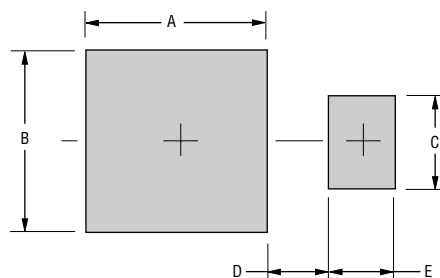

Dimension	DO-216AA
A (Max.)	$\frac{2.67}{(0.105)}$
B (Min.)	$\frac{2.54}{(0.100)}$
C (Min.)	$\frac{1.27}{(0.050)}$
D (Max.)	$\frac{0.635}{(0.025)}$
E (Min.)	$\frac{0.762}{(0.030)}$

Physical Specifications

Case JEDEC DO-216AA Molded plastic
 Polarity Cathode designated by TAB 1
 Weight Approximately 0.016 grams
 Mounting Position One way

Typical Part Marking

CD216A-B120L B2L
 CD216A-B120R B2E
 CD216A-B130L B3L
 CD216A-B140 B4S

How To Order

CD 216A - B 1 20 L LF

Common Code _____
 Chip Diode _____
 Package _____
 • 216A = DO-216AA
 Model _____
 B = Schottky Barrier Series
 Average Forward Current (I_o) Code _____
 1 = 1 A (Code x 1000 mA = Average Forward Current)
 Reverse Voltage (V_R) Code _____
 20 = 20 V
 30 = 30 V
 40 = 40 V
 Forward Voltage Suffix _____
 L = Low Forward Voltage V_f (CD216-B120L, CD216-B130L)
 R = Low Leakage Current IR (CD216-B120R)
 Terminations _____
 LF = 100 % Sn (lead free)

Specifications are subject to change without notice.

Customers should verify actual device performance in their specific applications.

CD216A-B120L ~ B140 MITE Chip Diode

BOURNS®

Rating and Characteristic Curves: CD216A-B120L

Forward Characteristics

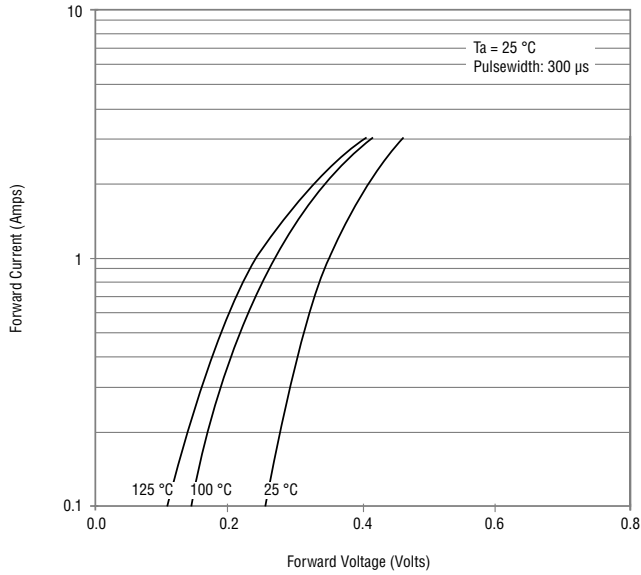

Reverse Characteristics

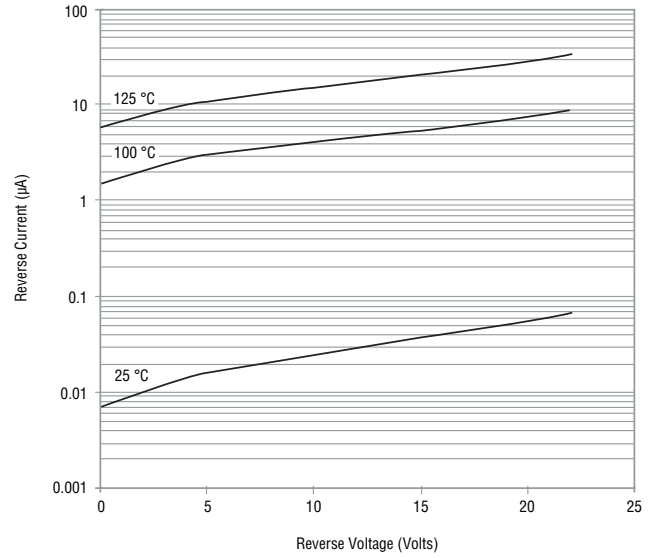

Derating Curve

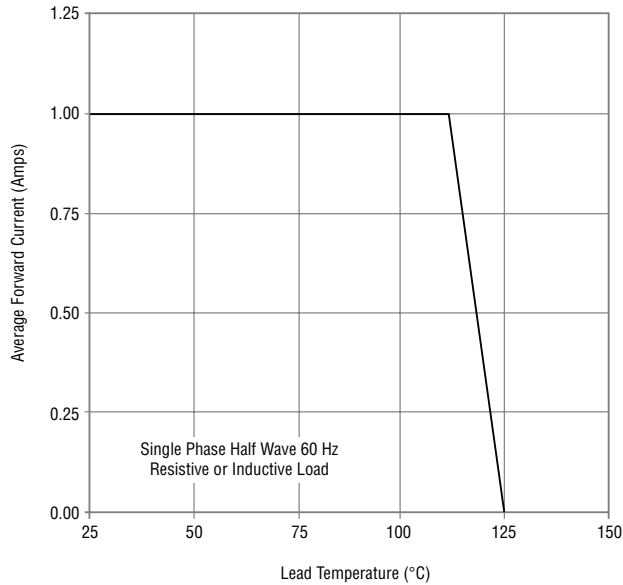

Capacitance Between Terminals

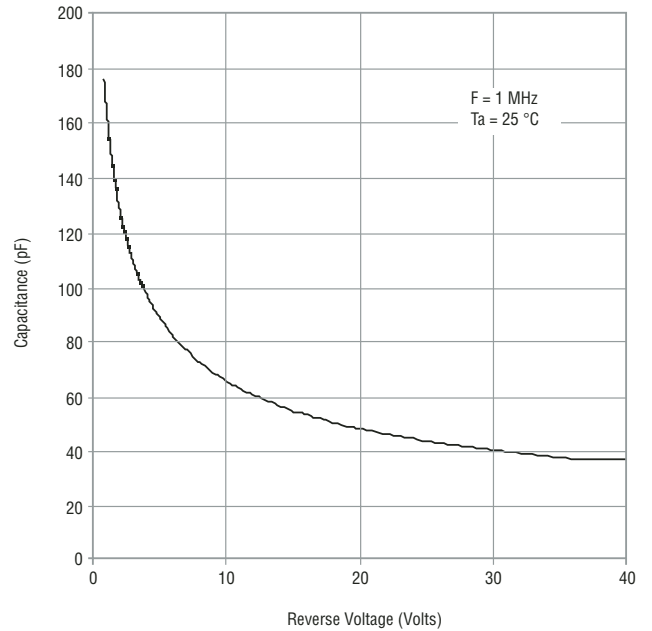

Specifications are subject to change without notice.
Customers should verify actual device performance in their specific applications.

CD216A-B120L ~ B140 MITE Chip Diode



Rating and Characteristic Curves: CD216A-B120R

Forward Characteristics

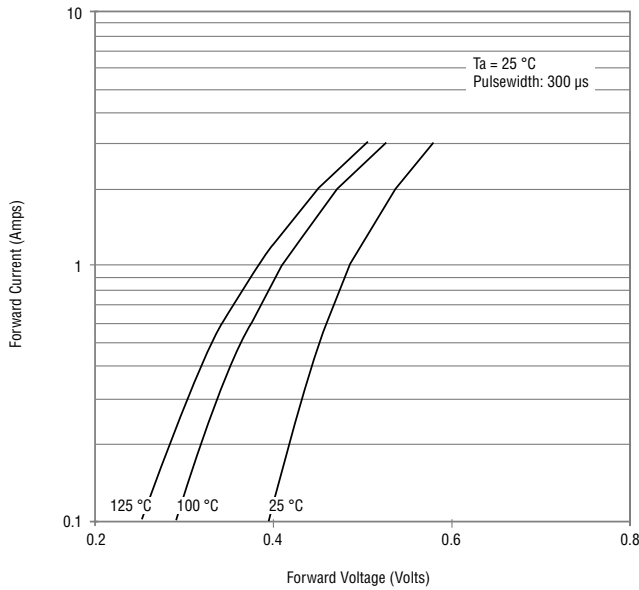

Reverse Characteristics

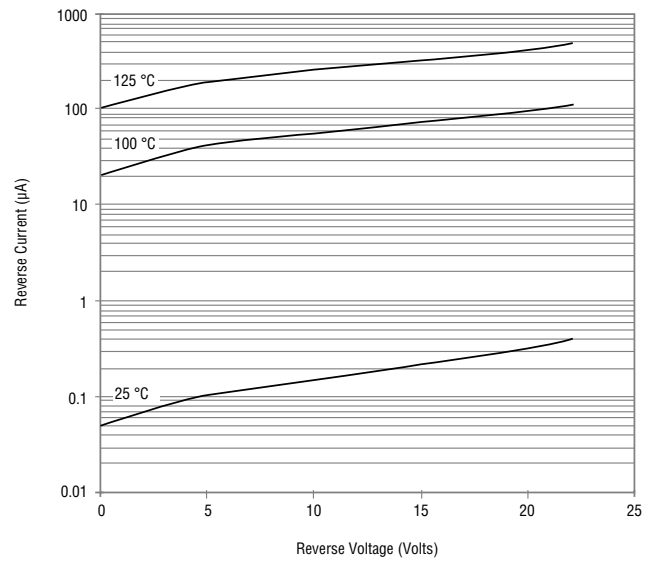

Derating Curve

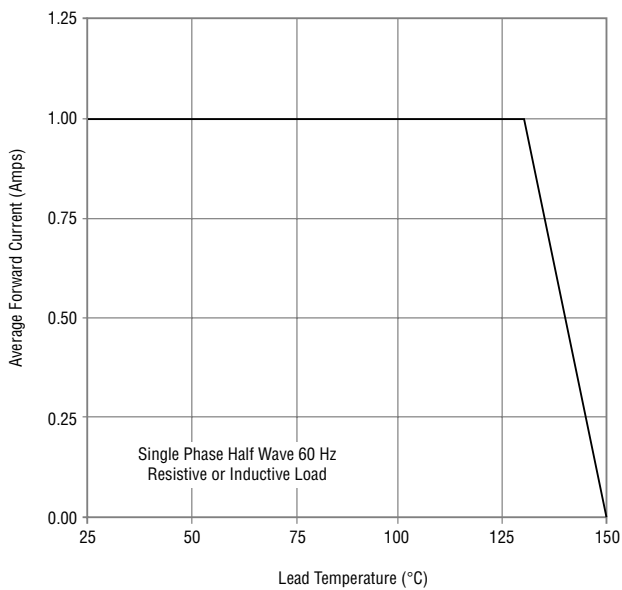

Capacitance Between Terminals

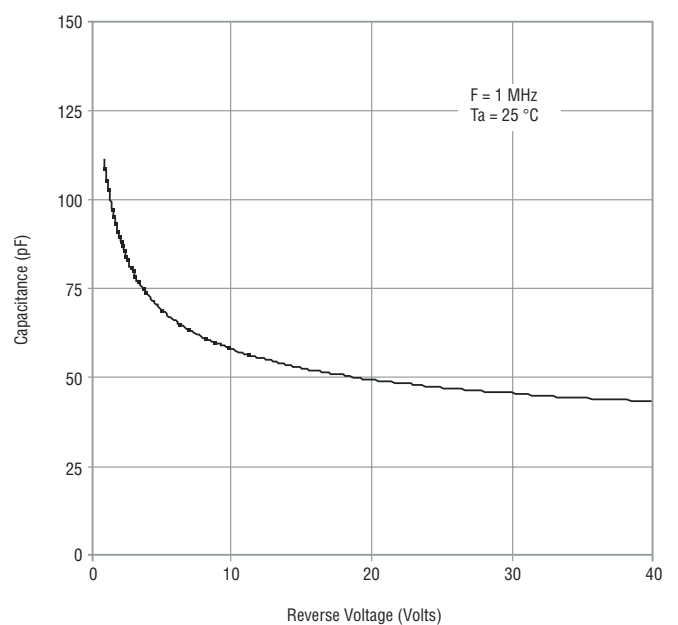

Specifications are subject to change without notice. Customers should verify actual device performance in their specific applications.

CD216A-B120L ~ B140 MITE Chip Diode



Rating and Characteristic Curves: CD216A-B130L

Forward Characteristics

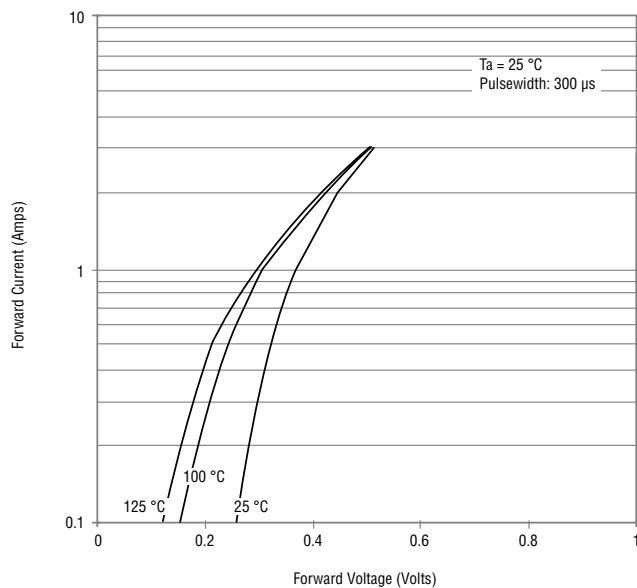

Reverse Characteristics

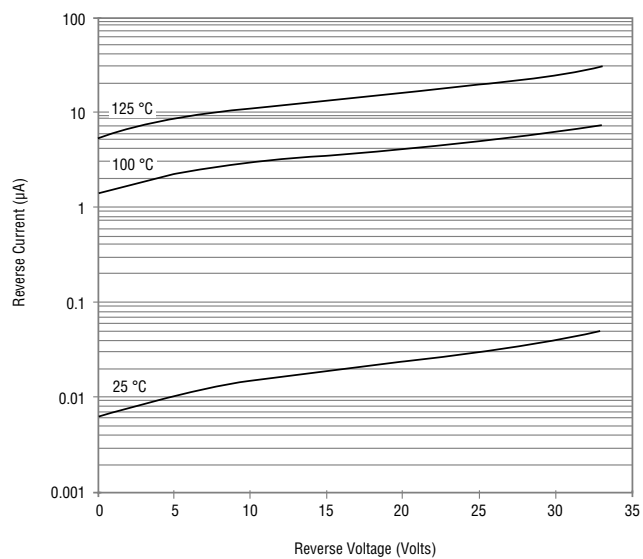

Derating Curve

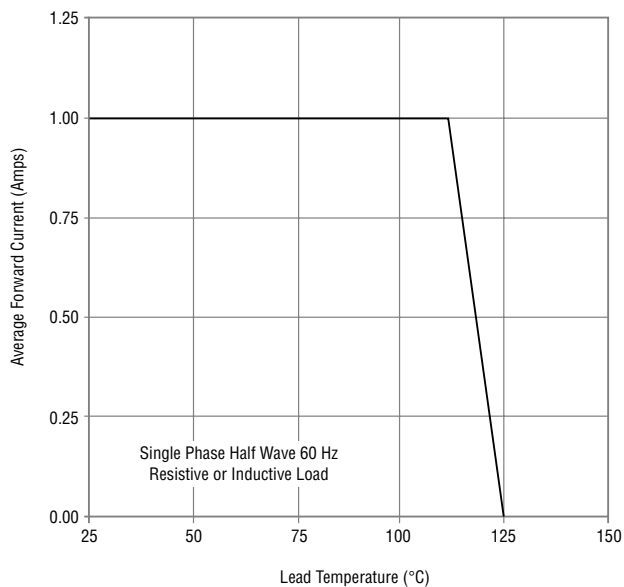

Capacitance Between Terminals

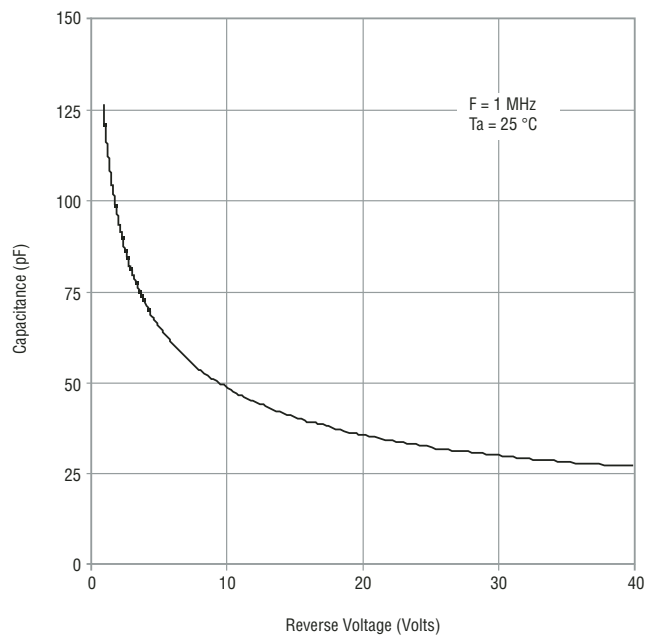

Specifications are subject to change without notice.
Customers should verify actual device performance in their specific applications.

CD216A-B120L ~ B140 MITE Chip Diode



Rating and Characteristic Curves: CD216A-B140

Forward Characteristics

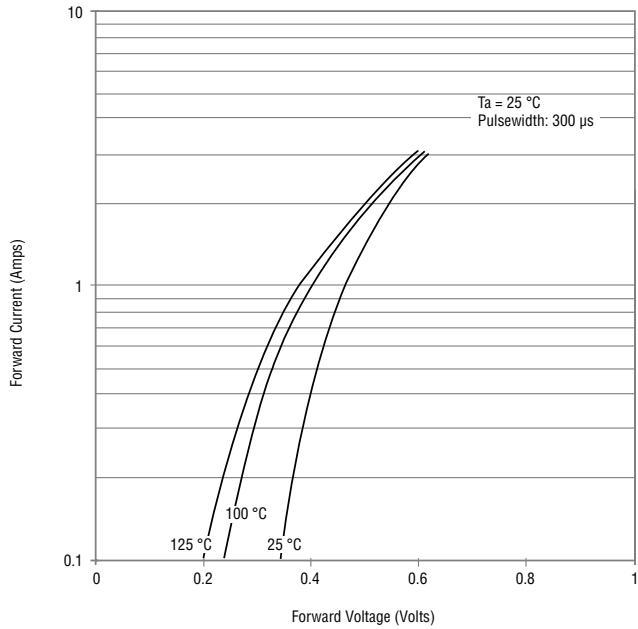

Reverse Characteristics

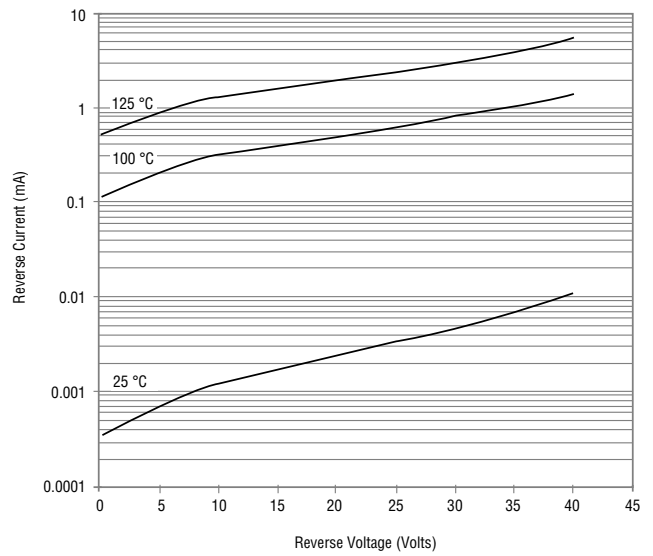

Derating Curve

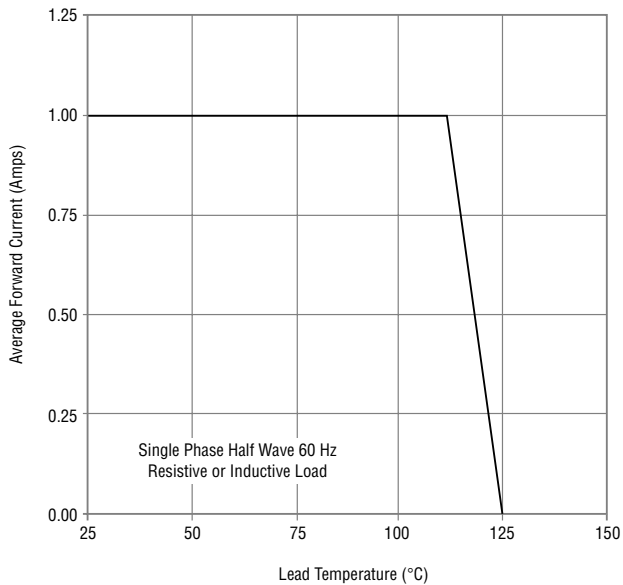

Capacitance Between Terminals

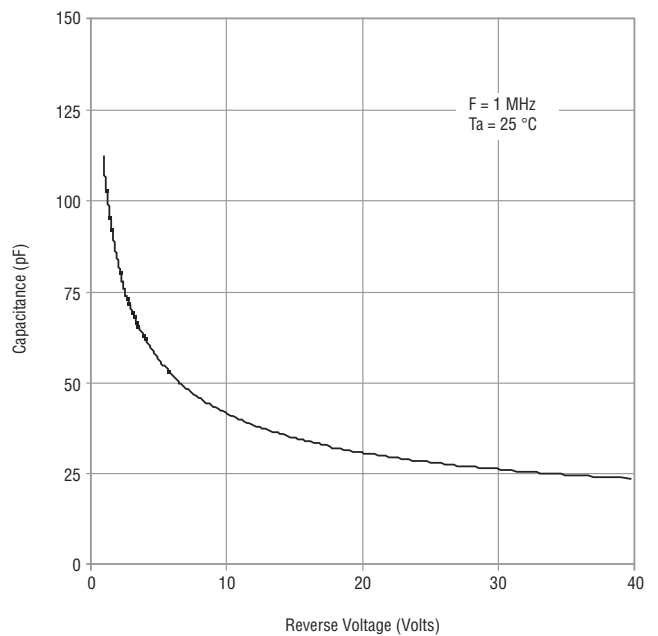

Specifications are subject to change without notice. Customers should verify actual device performance in their specific applications.

CD216A-B120L ~ B140 MITE Chip Diode

BOURNS®

Packaging Information

The product will be dispensed in Tape and Reel format (see diagram below).

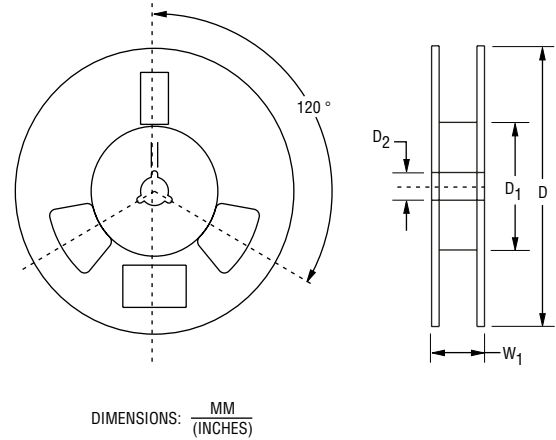
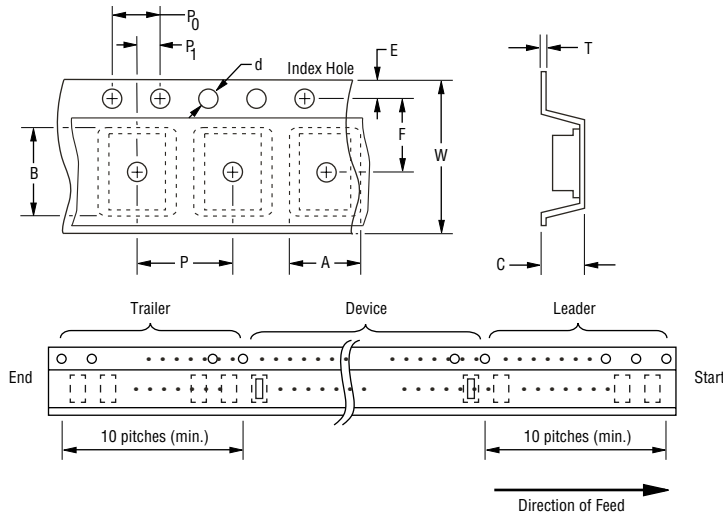

Devices are packed in accordance with EIA standard RS-481-A and specifications shown here.

Item	Symbol	DO-216AA
Carrier Width	A	$\frac{2.90 \pm 0.10}{(0.114 - 0.004)}$
Carrier Length	B	$\frac{5.30 \pm 0.10}{(0.209 - 0.004)}$
Carrier Depth	C	$\frac{1.37 \pm 0.10}{(0.054 - 0.004)}$
Sprocket Hole	d	$\frac{1.55 \pm 0.05}{(0.061 - 0.002)}$
Reel Outside Diameter	D	$\frac{330 / 178.0}{(12.992 / 7.007)}$
Reel Inner Diameter	D ₁	$\frac{75.0}{(2.953)}$ MIN.
Feed Hole Diameter	D ₂	$\frac{13.0 \pm 0.20}{(0.512 - 0.008)}$
Sprocket Hole Position	E	$\frac{1.75 \pm 0.10}{(0.069 - 0.004)}$
Punch Hole Position	F	$\frac{5.50 \pm 0.05}{(0.217 - 0.002)}$
Punch Hole Pitch	P	$\frac{4.00 \pm 0.10}{(0.157 - 0.004)}$
Sprocket Hole Pitch	P ₀	$\frac{4.00 \pm 0.10}{(0.157 - 0.004)}$
Embossment Center	P ₁	$\frac{2.00 \pm 0.05}{(0.079 - 0.002)}$
Overall Tape Thickness	T	$\frac{0.40 \pm 0.10}{(0.016 - 0.004)}$
Tape Width	W	$\frac{12.00 \pm 0.20}{(0.472 - 0.008)}$
Reel Width	W ₁	$\frac{18.4}{(0.724)}$ MAX.
Quantity per Reel	--	3,000

Specifications are subject to change without notice.
Customers should verify actual device performance in their specific applications.



Reliable Electronic Solutions

Asia-Pacific:

Tel: +886-2 2562-4117 • Fax: +886-2 2562-4116

Europe:

Tel: +41-(0)41 768 5555 • Fax: +41-(0)41 768 5510

The Americas:

Tel: +1-951 781-5500 • Fax: +1-951 781-5700

www.bourns.com