

General Description

The AAT3220 PowerLinear NanoPower low dropout (LDO) linear regulator is ideal for portable applications where extended battery life is critical. This device features extremely low quiescent current, typically 1.1µA. Dropout voltage is also very low, typically less than 225mV at the maximum output current of 150mA. The AAT3220 has output short-circuit and over-current protection. In addition, the device also has an over-temperature protection circuit which will shut down the LDO regulator during extended over-current events.

The AAT3220 is available in a Pb-free, space-saving SC59 package, or a Pb-free SOT-89 package for applications requiring increased power dissipation. The device is rated over the -40°C to +85°C temperature range. Since only a small, 1µF ceramic output capacitor is required, often the only space used is that occupied by the AAT3220 itself. The AAT3220 is truly a compact and cost-effective voltage conversion solution.

The AAT3221/2 is a similar product for this application, especially when a shutdown mode is required for further power savings.

Features

- 1.1µA Quiescent Current
- Low Dropout: 200mV (typ)
- Guaranteed 150mA Output
- High Accuracy: ±2.0%
- Current Limit and Over-Temperature Protection
- Low Temperature Coefficient
- Factory-Programmed Output Voltages: 1.8V to 3.5V
- Stable Operation With Virtually Any Output Capacitor Type
- 3-Pin SOT-89 or SC59 Package
- 4kV ESD Rating

Applications

- Cellular Phones
- Digital Cameras
- Handheld Electronics
- Notebook Computers
- PDAs
- Portable Communication Devices
- Remote Controls

Typical Application

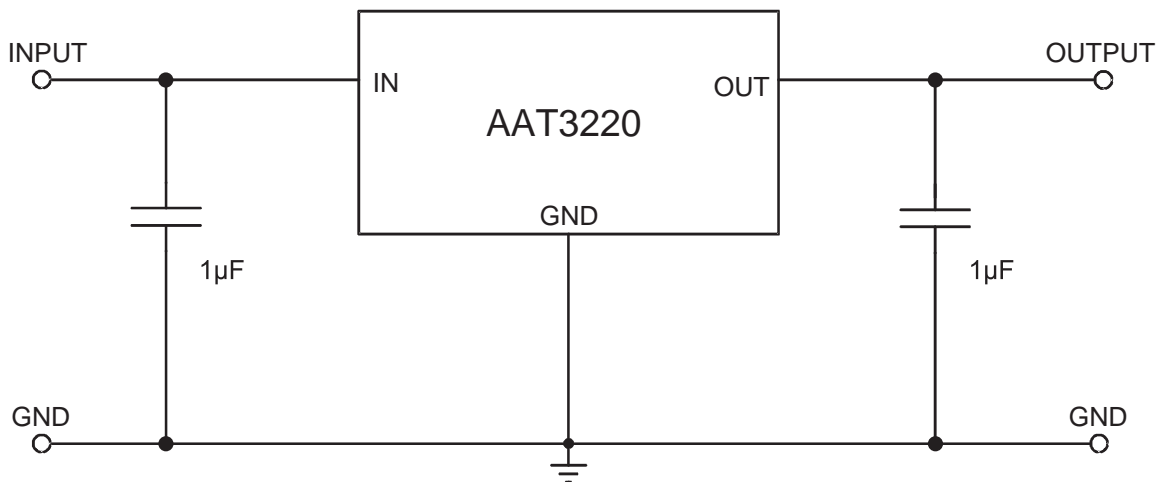

Pin Descriptions

Pin #		Symbol	Function
SC59	SOT-89		
1	1	GND	Ground connection.
3	2	IN	Input. Should be decoupled with 1 μ F or greater capacitor.
2	3	OUT	Output. Should be decoupled with 1 μ F or greater output capacitor.

Pin Configuration

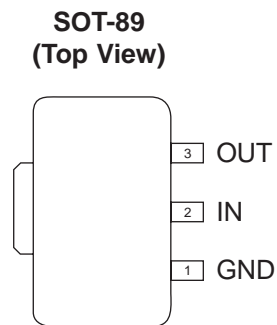
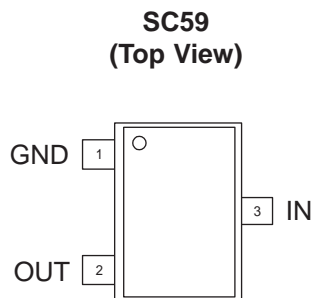

Absolute Maximum Ratings¹

$T_A = 25^\circ\text{C}$, unless otherwise noted.

Symbol	Description	Value	Units
V_{IN}	Input Voltage	-0.3 to 6	V
I_{OUT}	DC Output Current	$P_D / (V_{IN} - V_O)$	mA
T_J	Operating Junction Temperature Range	-40 to 150	$^\circ\text{C}$
T_{LEAD}	Maximum Soldering Temperature (at leads, 10 sec)	300	$^\circ\text{C}$
V_{ESD}	ESD Rating ² — HBM	4000	V

Thermal Information³

Symbol	Description		Rating	Units
Θ_{JA}	Maximum Thermal Resistance	SC59	200	$^\circ\text{C}/\text{W}$
		SOT-89	50	
P_D	Maximum Power Dissipation	SC59	500	mW
		SOT-89	2	W

Recommended Operating Conditions

Symbol	Description	Rating	Units
V_{IN}	Input Voltage ⁴	$(V_{OUT} + V_{DO})$ to 5.5	V
T	Ambient Temperature Range	-40 to +85	$^\circ\text{C}$

- Stresses above those listed in Absolute Maximum Ratings may cause permanent damage to the device. Functional operation at conditions other than the operating conditions specified is not implied. Only one Absolute Maximum Rating should be applied at any one time.
- Human body model is a 100pF capacitor discharged through a 1.5k Ω resistor into each pin.
- Mounted on a demo board.
- To calculate minimum input voltage, use the following equation: $V_{IN(MIN)} = V_{OUT(MAX)} + V_{DO(MAX)}$ as long as $V_{IN} \geq 2.5\text{V}$.

Electrical Characteristics

$V_{IN} = V_{OUT(NOM)} + 1V$, $I_{OUT} = 1mA$, $C_{OUT} = 1\mu F$, $T_A = 25^\circ C$, unless otherwise noted.

Symbol	Description	Conditions	Min	Typ	Max	Units
V_{OUT}	DC Output Voltage Tolerance		-2.0		2.0	%
I_{OUT}	Output Current	$V_{OUT} > 1.2V$	150			mA
I_{SC}	Short-Circuit Current	$V_{OUT} < 0.4V$		350		mA
I_Q	Ground Current	$V_{IN} = 5V$, No Load		1.1	2.5	μA
$\Delta V_{OUT}/V_{OUT}$	Line Regulation	$V_{IN} = 4.0$ to $5.5V$		0.15	0.4	%/V
$\Delta V_{OUT}/V_{OUT}$	Load Regulation	$I_L = 1$ to $100mA$	$V_{OUT} = 1.8$	1.0	1.65	%
			$V_{OUT} = 2.0$	0.9	1.60	
			$V_{OUT} = 2.3$	0.8	1.45	
			$V_{OUT} = 2.4$	0.8	1.40	
			$V_{OUT} = 2.5$	0.8	1.35	
			$V_{OUT} = 2.7$	0.7	1.25	
			$V_{OUT} = 2.8$	0.7	1.20	
			$V_{OUT} = 2.85$	0.7	1.20	
			$V_{OUT} = 2.9$	0.7	1.18	
			$V_{OUT} = 3.0$	0.6	1.15	
			$V_{OUT} = 3.3$	0.5	1.00	
			$V_{OUT} = 3.5$	0.5	1.00	
V_{DO}	Dropout Voltage ^{1,2}	$I_{OUT} = 100mA$	$V_{OUT} = 2.3$	230	275	mV
			$V_{OUT} = 2.4$	220	265	
			$V_{OUT} = 2.5$	210	255	
			$V_{OUT} = 2.7$	200	240	
			$V_{OUT} = 2.8$	190	235	
			$V_{OUT} = 2.85$	190	230	
			$V_{OUT} = 2.9$	190	228	
			$V_{OUT} = 3.0$	190	225	
			$V_{OUT} = 3.3$	180	220	
$V_{OUT} = 3.5$	180	220				
PSRR	Power Supply Rejection Ratio	100Hz		50		dB
T_{SD}	Over-Temperature Shutdown Threshold			140		$^\circ C$
T_{HYS}	Over-Temperature Shutdown Hysteresis			20		$^\circ C$
e_N	Output Noise	10Hz through 10kHz		350		μV
T_C	Output Voltage Temperature Coefficient			80		ppm/ $^\circ C$

1. V_{DO} is defined as $V_{IN} - V_{OUT}$ when V_{OUT} is 98% of nominal.

2. For $V_{OUT} < 2.3V$, $V_{DO} = 2.5V - V_{OUT}$.

Typical Characteristics

$V_{IN} = V_{OUT} + 1V$, $T_A = 25^\circ\text{C}$, output capacitor is $1\mu\text{F}$ ceramic, $I_{OUT} = 40\text{mA}$, unless otherwise noted.

Output Voltage vs. Output Current

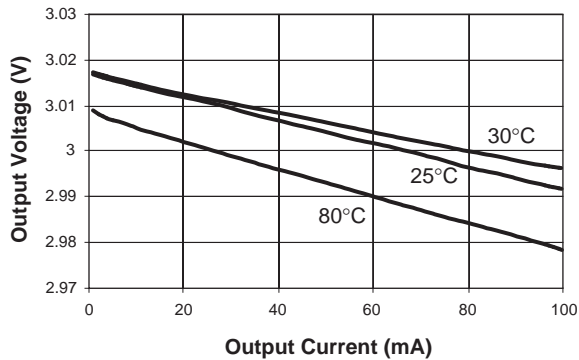

Output Voltage vs. Input Voltage

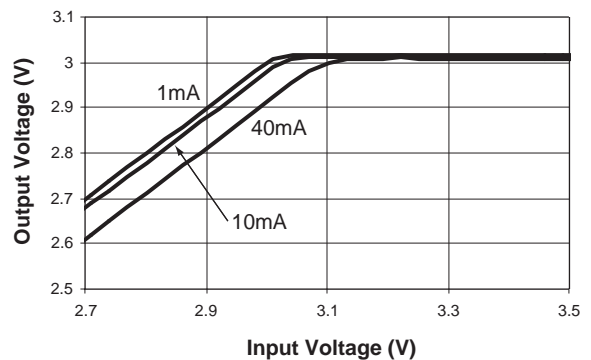

Output Voltage vs. Input Voltage

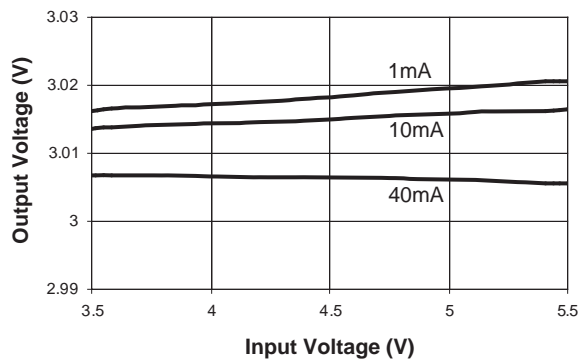

Dropout Voltage vs. Output Current

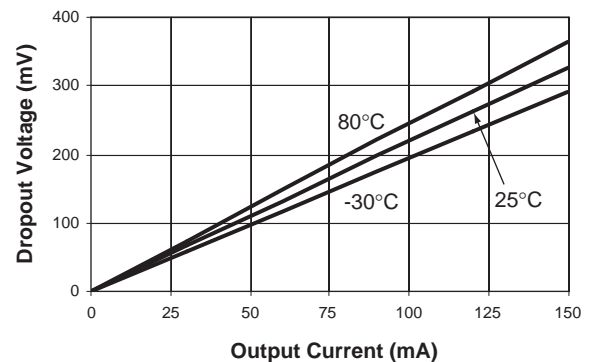

Supply Current vs. Input Voltage

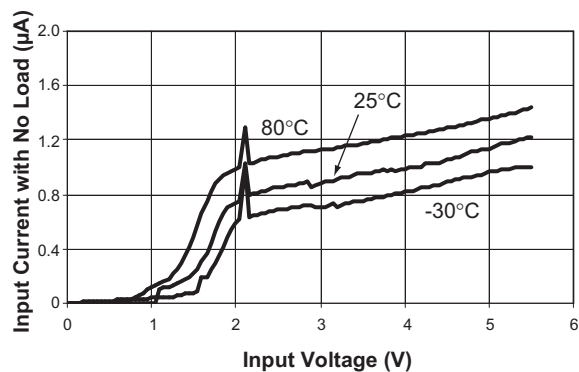

PSRR with 10mA Load

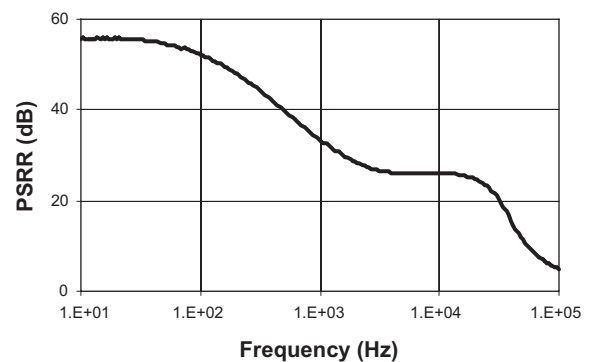

Typical Characteristics

$V_{IN} = V_{OUT} + 1V$, $T_A = 25^\circ C$, output capacitor is $1\mu F$ ceramic, $I_{OUT} = 40mA$, unless otherwise noted.

AAT3220 Noise Spectrum

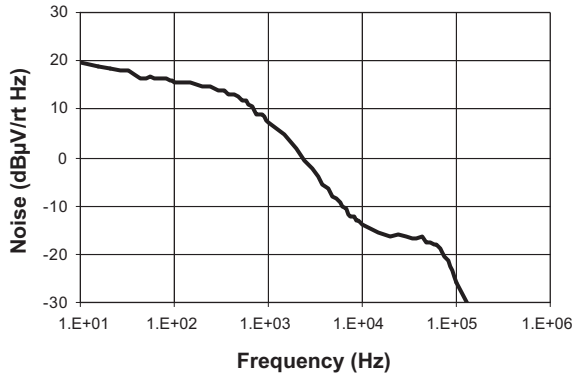

Line Response with 1mA Load

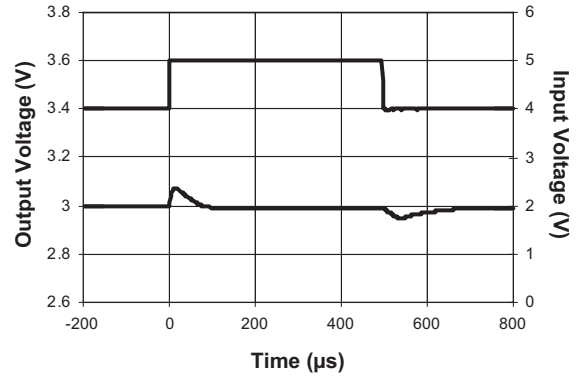

Line Response with 10mA Load

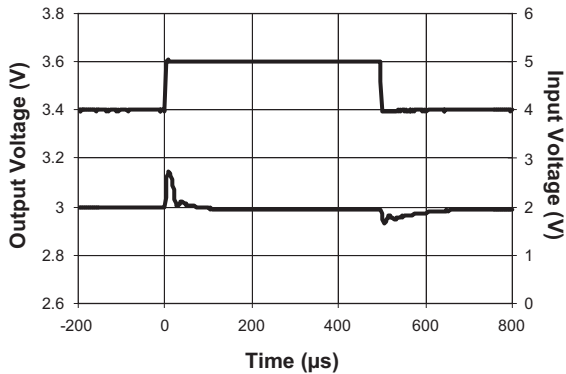

Line Response with 100mA Load

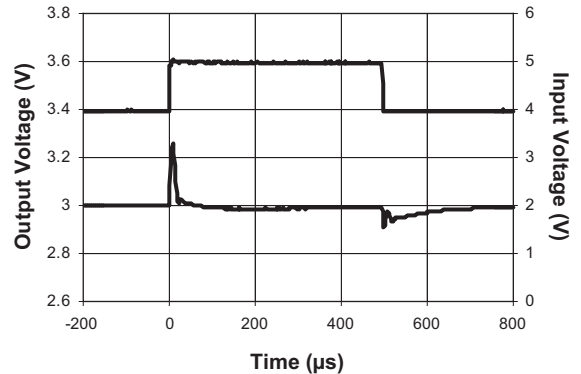

Load Transient (1mA / 40mA)

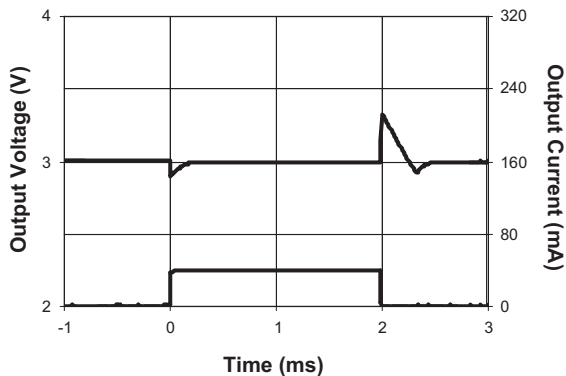

Load Transient (1mA / 80mA)

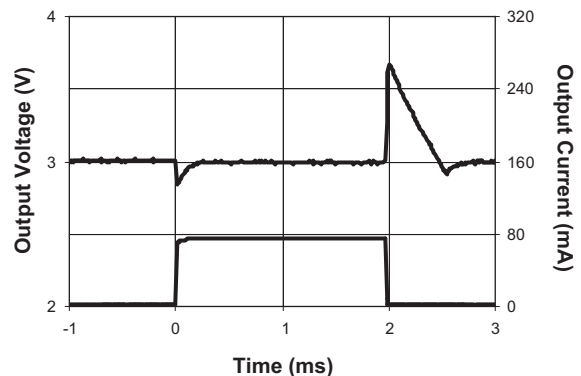

Typical Characteristics

$V_{IN} = V_{OUT} + 1V$, $T_A = 25^\circ C$, output capacitor is $1\mu F$ ceramic, $I_{OUT} = 40mA$, unless otherwise noted.

Power-Up with 1mA Load

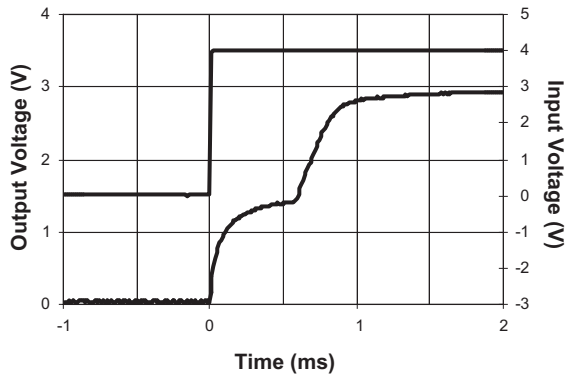

Power-Up with 10mA Load

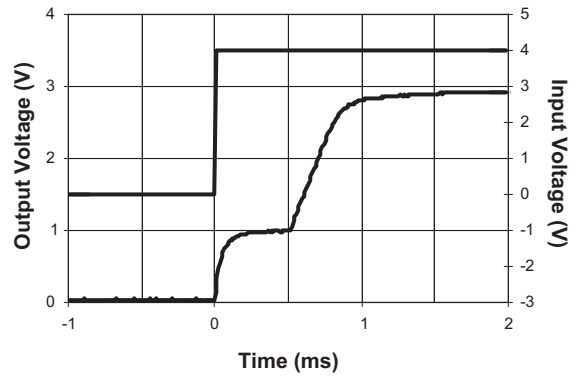

Power-Up with 100mA Load

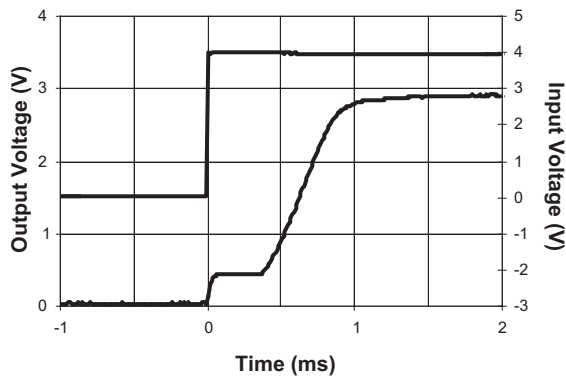

Functional Block Diagram

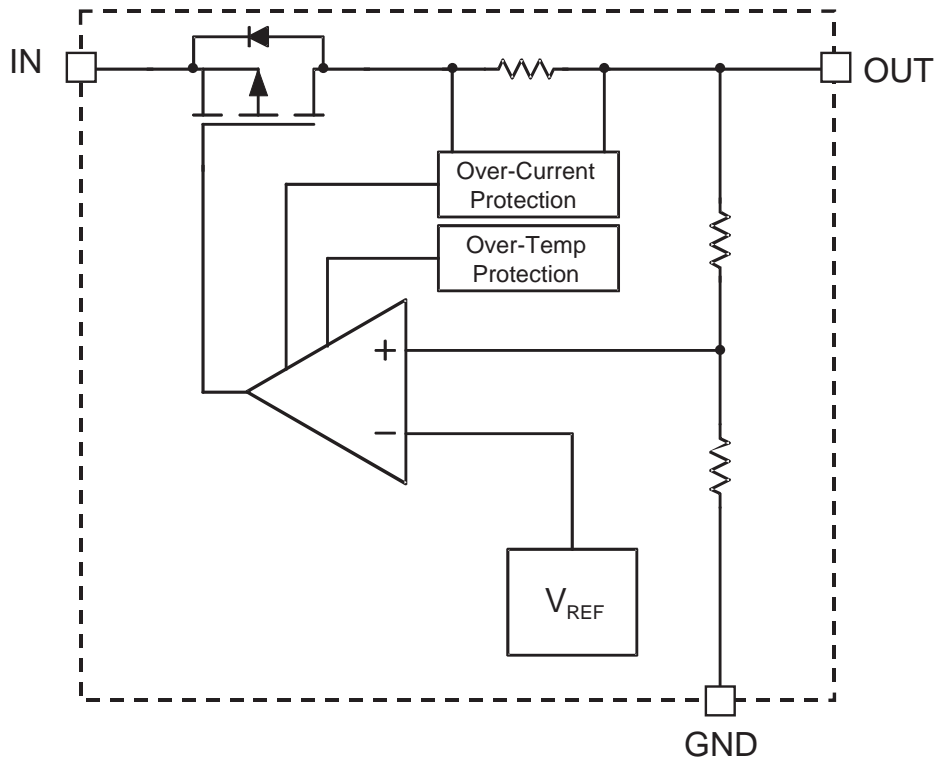

Functional Description

The AAT3220 is intended for LDO regulator applications where output current load requirements range from no load to 150mA.

The advanced circuit design of the AAT3220 has been optimized for minimum quiescent or ground current consumption, making it ideal for use in power management systems for small battery-operated devices. The typical quiescent current level is just 1.1µA. The LDO also demonstrates excellent power supply ripple rejection (PSRR) and load and line transient response characteristics. The AAT3220 is a truly high performance LDO regulator especially well suited for circuit applications which are sensitive to load circuit power consumption and extended battery life.

The LDO regulator output has been specifically optimized to function with low cost, low equivalent series resistance (ESR) ceramic capacitors. However, the design will allow for operation with a wide range of capacitor types.

The AAT3220 has complete short-circuit and thermal protection. The integral combination of these two internal protection circuits give the AAT3220 a comprehensive safety system to guard against extreme adverse operating conditions. Device power dissipation is limited to the package type and thermal dissipation properties. Refer to the Thermal Considerations section of this datasheet for details on device operation at maximum output load levels.

Applications Information

To assure the maximum possible performance is obtained from the AAT3220, please refer to the following application recommendations.

Input Capacitor

Typically, a 1µF or larger capacitor is recommended for C_{IN} in most applications. A C_{IN} capacitor is not required for basic LDO regulator operation. However, if the AAT3220 is physically located any distance more than one or two centimeters from the input power source, a C_{IN} capacitor will be needed for stable operation. C_{IN} should be located as close to the device V_{IN} pin as practically possible. C_{IN} values greater than 1µF will offer superior input line transient response and will assist in maximizing the highest possible power supply ripple rejection.

Ceramic, tantalum, or aluminum electrolytic capacitors may be selected for C_{IN}. There is no specific capacitor ESR requirement for C_{IN}. For 150mA LDO regulator output operation, ceramic capacitors are recommended for C_{IN} due to their inherent capability over tantalum capacitors to withstand input current surges from low-impedance sources such as batteries in portable devices.

Output Capacitor

For proper load voltage regulation and operational stability, a capacitor is required between pins V_{OUT} and GND. The C_{OUT} capacitor connection to the LDO regulator ground pin should be as direct as practically possible for maximum device performance. The AAT3220 has been specifically designed to function with very low ESR ceramic capacitors. Although the device is intended to operate with low ESR capacitors, it is stable over a very wide range of capacitor ESR, thus it will also work with some higher ESR tantalum or aluminum electrolytic capacitors. However, for best performance, ceramic capacitors are recommended.

The value of C_{OUT} typically ranges from 0.47µF to 10µF; however, 1µF is sufficient for most operating conditions.

If large output current steps are required by an application, then an increased value for C_{OUT} should be considered. The amount of capacitance needed can be calculated from the step size of the change in the output load current expected and the voltage excursion that the load can tolerate.

The total output capacitance required can be calculated using the following formula:

$$C_{OUT} = \frac{\Delta I}{\Delta V} \times 15\mu F$$

Where:

ΔI = maximum step in output current

ΔV = maximum excursion in voltage that the load can tolerate.

Note that use of this equation results in capacitor values approximately two to four times the typical value needed for an AAT3220 at room temperature. The increased capacitor value is recommended if tight output tolerances must be maintained over extreme operating conditions and maximum operational temperature excursions. If tantalum or aluminum electrolytic capacitors are used, the capacitor value should be increased to compensate for the substantial ESR inherent to these capacitor types.

Capacitor Characteristics

Ceramic composition capacitors are highly recommended over all other types of capacitors for use with the AAT3220. Ceramic capacitors offer many advantages over their tantalum and aluminum electrolytic counterparts. A ceramic capacitor typically has very low ESR, is lower cost, has a smaller PCB footprint, and is non-polarized. Line and load transient response of the LDO regulator is improved by using low ESR ceramic capacitors. Since ceramic capacitors are non-polarized, they are less prone to damage if incorrectly connected.

Equivalent Series Resistance: ESR is a very important characteristic to consider when selecting a capacitor. ESR is the internal series resistance associated with a capacitor that includes lead

resistance, internal connections, capacitor size and area, material composition, and ambient temperature. Typically, capacitor ESR is measured in milliohms for ceramic capacitors and can range to more than several ohms for tantalum or aluminum electrolytic capacitors.

Ceramic Capacitor Materials: Ceramic capacitors less than 0.1 μ F are typically made from NPO or C0G materials. NPO and C0G materials generally have tight tolerance and are very stable over temperature. Larger capacitor values are usually composed of X7R, X5R, Z5U, or Y5V dielectric materials. Large ceramic capacitors (i.e., greater than 2.2 μ F) are often available in low-cost Y5V and Z5U dielectrics. These two material types are not recommended for use with LDO regulators since the capacitor tolerance can vary by more than $\pm 50\%$ over the operating temperature range of the device. A 2.2 μ F Y5V capacitor could be reduced to 1 μ F over the full operating temperature range. This can cause problems for circuit operation and stability. X7R and X5R dielectrics are much more desirable. The temperature tolerance of X7R dielectric is better than $\pm 15\%$.

Capacitor area is another contributor to ESR. Capacitors, which are physically large in size will have a lower ESR when compared to a smaller sized capacitor of equivalent material and capacitance value. These larger devices can also improve circuit transient response when compared to an equal value capacitor in a smaller package size.

Consult capacitor vendor datasheets carefully when selecting capacitors for use with LDO regulators.

Short-Circuit and Thermal Protection

The AAT3220 is protected by both current limit and over-temperature protection circuitry. The internal short-circuit current limit is designed to activate when the output load demand exceeds the maximum rated output. If a short-circuit condition were to continually draw more than the current limit threshold, the LDO regulator's output voltage would drop to a level necessary to supply the cur-

rent demanded by the load. Under short-circuit or other over-current operating conditions, the output voltage would drop and the AAT3220's die temperature would increase rapidly. Once the regulator's power dissipation capacity has been exceeded and the internal die temperature reaches approximately 140°C the system thermal protection circuit will become active. The internal thermal protection circuit will actively turn off the LDO regulator output pass device to prevent the possibility of over-temperature damage. The LDO regulator output will remain in a shutdown state until the internal die temperature falls back below the 140°C trip point.

The combination and interaction between the short-circuit and thermal protection systems allows the LDO regulator to withstand indefinite short-circuit conditions without sustaining permanent damage.

No-Load Stability

The AAT3220 is designed to maintain output voltage regulation and stability under operational no-load conditions. This is an important characteristic for applications where the output current may drop to zero. An output capacitor is required for stability under no-load operating conditions. Refer to the Output Capacitor section of this datasheet for recommended typical output capacitor values.

Thermal Considerations and High Output Current Applications

The AAT3220 is designed to deliver a continuous output load current of 150mA under normal operating conditions. The limiting characteristic for the maximum output load safe operating area is essentially package power dissipation and the internal pre-set thermal limit of the device. In order to obtain high operating currents, careful device layout and circuit operating conditions need to be taken into account. The following discussions will assume the LDO regulator is mounted on a printed circuit board utilizing the minimum recommended footprint and the printed circuit board is 0.062 inch thick FR4 material with one ounce copper.

At any given ambient temperature (T_A), the maximum package power dissipation can be determined by the following equation:

$$P_{D(MAX)} = \frac{T_{J(MAX)} - T_A}{\theta_{JA}}$$

Constants for the AAT3220 are $T_{J(MAX)}$, the maximum junction temperature for the device which is 125°C and $\theta_{JA} = 200^\circ\text{C/W}$, the package thermal resistance. Typically, maximum conditions are calculated at the maximum operating temperature where $T_A = 85^\circ\text{C}$; under normal ambient conditions $T_A = 25^\circ\text{C}$. Given $T_A = 85^\circ\text{C}$, the maximum package power dissipation is 200mW. At $T_A = 25^\circ\text{C}$, the maximum package power dissipation is 500mW.

The maximum continuous output current for the AAT3220 is a function of the package power dissipation and the input-to-output voltage drop across the LDO regulator. Refer to the following simple equation:

$$I_{OUT(MAX)} < \frac{P_{D(MAX)}}{V_{IN} - V_{OUT}}$$

For example, if $V_{IN} = 5\text{V}$, $V_{OUT} = 3\text{V}$ and $T_A = 25^\circ\text{C}$, $I_{OUT(MAX)} < 250\text{mA}$. The output short-circuit protection threshold is set between 150mA and 300mA. If the output load current were to exceed 250mA or if the ambient temperature were to increase, the internal die temperature would increase. If the condition remained constant and the short-circuit protection did not activate, there would be a potential damage hazard to the LDO regulator since the thermal protection circuit will only activate after a short-circuit event occurs on the LDO regulator output.

To determine the maximum input voltage for a given load current, refer to the following equation. This calculation accounts for the total power dissipation of the LDO regulator, including that caused by ground current.

$$P_{D(MAX)} = (V_{IN} - V_{OUT})I_{OUT} + (V_{IN} \times I_{GND})$$

This formula can be solved for V_{IN} to determine the maximum input voltage.

$$V_{IN(MAX)} = \frac{P_{D(MAX)} + (V_{OUT} \times I_{OUT})}{I_{OUT} + I_{GND}}$$

The following is an example for an AAT3220 set for a 3.0V output:

$$\begin{aligned} V_{OUT} &= 3.0\text{V} \\ I_{OUT} &= 150\text{mA} \\ I_{GND} &= 1.1\mu\text{A} \\ V_{IN(MAX)} &= \frac{500\text{mW} + (3.0\text{V} \times 150\text{mA})}{150\text{mA} + 1.1\mu\text{A}} \\ V_{IN(MAX)} &= > 5.5\text{V} \end{aligned}$$

From the discussion above, $P_{D(MAX)}$ was determined to equal 417mW at $T_A = 25^\circ\text{C}$.

Thus, the AAT3220 can sustain a constant 3.0V output at a 150mA load current as long as V_{IN} is $\leq 5.5\text{V}$ at an ambient temperature of 25°C. 5.5V is the maximum input operating voltage for the AAT3220, thus at 25°C, the device would not have any thermal concerns or operational $V_{IN(MAX)}$ limits.

This situation can be different at 85°C. The following is an example for an AAT3220 set for a 3.0V output at 85°C:

$$\begin{aligned} V_{OUT} &= 3.0\text{V} \\ I_{OUT} &= 150\text{mA} \\ I_{GND} &= 1.1\mu\text{A} \\ V_{IN(MAX)} &= \frac{200\text{mW} + (3.0\text{V} \times 150\text{mA})}{150\text{mA} + 1.1\mu\text{A}} \\ V_{IN(MAX)} &= 4.33\text{V} \end{aligned}$$

From the discussion above, $P_{D(MAX)}$ was determined to equal 200mW at $T_A = 85^\circ\text{C}$.

Higher input-to-output voltage differentials can be obtained with the AAT3220 while maintaining device functions in the thermal safe operating area. To accomplish this, the device thermal resistance must be reduced by increasing the heat sink area or by operating the LDO regulator in a duty-cycled mode.

For example, an application requires $V_{IN} = 5.0\text{V}$ while $V_{OUT} = 3.0\text{V}$ at a 150mA load and $T_A = 85^\circ\text{C}$. V_{IN} is greater than 4.33V, which is the maximum safe continuous input level for $V_{OUT} = 3.0\text{V}$ at 150mA for $T_A = 85^\circ\text{C}$. To maintain this high input voltage and output current level, the LDO regulator must be operated in a duty-cycled mode. Refer to the following calculation for duty-cycle operation:

$$I_{GND} = 1.1\mu\text{A}$$

$$I_{OUT} = 150\text{mA}$$

$$V_{IN} = 5.0\text{V}$$

$$V_{OUT} = 3.0\text{V}$$

$$\%DC = 100 \frac{P_{D(MAX)}}{(V_{IN} - V_{OUT})I_{OUT} + (V_{IN} \times I_{GND})}$$

$$\%DC = 100 \frac{200\text{mW}}{(5.0\text{V} - 3.0\text{V})150\text{mA} + (5.0\text{V} \times 1.1\mu\text{A})}$$

$$\%DC = 66.67\%$$

$P_{D(MAX)}$ is assumed to be 200mW

For a 150mA output current and a 2.0V drop across the AAT3220 at an ambient temperature of 85°C , the maximum on-time duty cycle for the device would be 66.67%.

The following family of curves shows the safe operating area for duty-cycled operation from ambient room temperature to the maximum operating level.

Device Duty Cycle vs. V_{DROP}
($V_{OUT} = 2.5\text{V} @ 25^\circ\text{C}$)

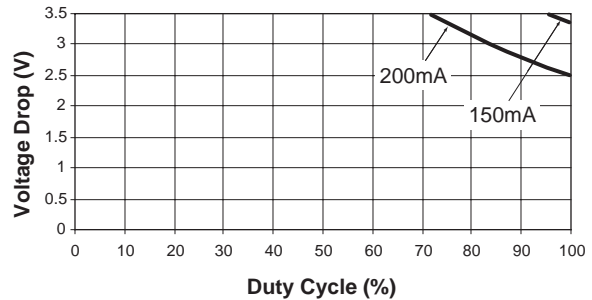

Device Duty Cycle vs. V_{DROP}
($V_{OUT} = 2.5\text{V} @ 50^\circ\text{C}$)

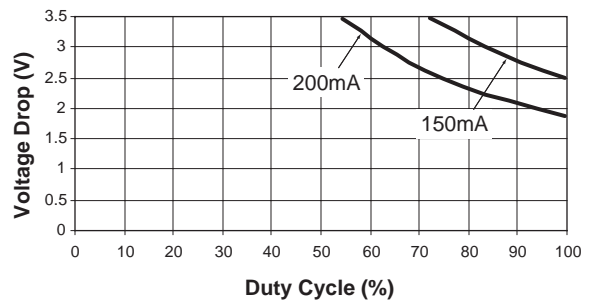

Device Duty Cycle vs. V_{DROP}
($V_{OUT} = 2.5\text{V} @ 85^\circ\text{C}$)

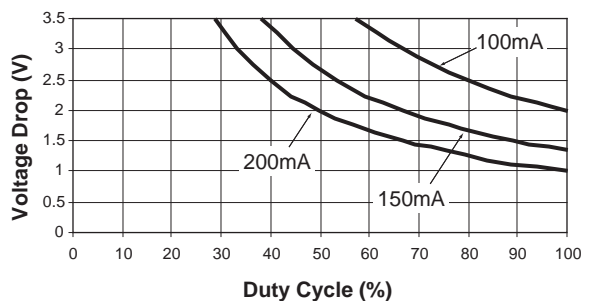

High Peak Output Current Applications

Some applications require the LDO regulator to operate at continuous nominal levels with short duration, high-current peaks. The duty cycles for both output current levels must be taken into account. To do so, first calculate the power dissipation at the nominal continuous level, then factor in the addition power dissipation due to the short duration, high-current peaks.

For example, a 3.0V system using a AAT3220IGV-2.5-T1 operates at a continuous 100mA load current level and has short 150mA current peaks. The current peak occurs for 378µs out of a 4.61ms period. It will be assumed the input voltage is 5.0V.

First, the current duty cycle percentage must be calculated:

$$\begin{aligned} \% \text{ Peak Duty Cycle: } X/100 &= 378\mu\text{s}/4.61\text{ms} \\ \% \text{ Peak Duty Cycle} &= 8.2\% \end{aligned}$$

The LDO regulator will be under the 100mA load for 91.8% of the 4.61ms period and have 150mA peaks occurring for 8.2% of the time. Next, the continuous nominal power dissipation for the 100mA load should be determined then multiplied by the duty cycle to conclude the actual power dissipation over time.

$$\begin{aligned} P_{D(\text{MAX})} &= (V_{\text{IN}} - V_{\text{OUT}})I_{\text{OUT}} + (V_{\text{IN}} \times I_{\text{GND}}) \\ P_{D(100\text{mA})} &= (4.2\text{V} - 3.0\text{V})100\text{mA} + (4.2\text{V} \times 1.1\mu\text{A}) \\ P_{D(100\text{mA})} &= 120\text{mW} \end{aligned}$$

$$\begin{aligned} P_{D(91.8\%D/C)} &= \%DC \times P_{D(100\text{mA})} \\ P_{D(91.8\%D/C)} &= 0.918 \times 120\text{mW} \\ P_{D(91.8\%D/C)} &= 110.2\text{mW} \end{aligned}$$

The power dissipation for 100mA load occurring for 91.8% of the duty cycle will be 110.2mW. Now the power dissipation for the remaining 8.2% of the duty cycle at the 150mA load can be calculated:

$$\begin{aligned} P_{D(\text{MAX})} &= (V_{\text{IN}} - V_{\text{OUT}})I_{\text{OUT}} + (V_{\text{IN}} \times I_{\text{GND}}) \\ P_{D(150\text{mA})} &= (4.2\text{V} - 3.0\text{V})150\text{mA} + (4.2\text{V} \times 1.1\mu\text{A}) \\ P_{D(150\text{mA})} &= 180\text{mW} \end{aligned}$$

$$\begin{aligned} P_{D(8.2\%D/C)} &= \%DC \times P_{D(150\text{mA})} \\ P_{D(8.2\%D/C)} &= 0.082 \times 180\text{mW} \\ P_{D(8.2\%D/C)} &= 14.8\text{mW} \end{aligned}$$

The power dissipation for a 150mA load occurring for 8.2% of the duty cycle will be 14.8mW. Finally, the two power dissipation levels can be summed to determine the total power dissipation under the varied load.

$$\begin{aligned} P_{D(\text{total})} &= P_{D(100\text{mA})} + P_{D(150\text{mA})} \\ P_{D(\text{total})} &= 110.2\text{mW} + 14.8\text{mW} \\ P_{D(\text{total})} &= 125.0\text{mW} \end{aligned}$$

The maximum power dissipation for the AAT3220 operating at an ambient temperature of 85°C is 200mW. The device in this example will have a total power dissipation of 125.0mW. This is well within the thermal limits for safe operation of the device.

Printed Circuit Board Layout Recommendations

In order to obtain the maximum performance from the AAT3220 LDO regulator, very careful attention must be paid in regard to the printed circuit board layout. If grounding connections are not properly made, power supply ripple rejection and LDO regulator transient response can be compromised.

The LDO regulator external capacitors C_{IN} and C_{OUT} should be connected as directly as possible to the ground pin of the LDO regulator. For maximum performance with the AAT3220, the ground pin connection should then be made directly back to the ground or common of the source power supply. If a direct ground return path is not possible due to printed circuit board layout limitations, the LDO ground pin should then be connected to the common ground plane in the application layout.

Ordering Information

Output Voltage	Package	Marking ¹	Part Number (Tape and Reel) ²
1.8V	SC59	BAXYY	AAT3220IGY-1.8-T1
2.0V	SC59	EZXYY	AAT3220IGY-2.0-T1
2.3V	SC59	AYXYY	AAT3220IGY-2.3-T1
2.4V	SC59	AXXYY	AAT3220IGY-2.4-T1
2.5V	SC59	ADXYY	AAT3220IGY-2.5-T1
2.7V	SC59	AEXYY	AAT3220IGY-2.7-T1
2.8V	SC59	AFXYY	AAT3220IGY-2.8-T1
2.85V	SC59	FZXYY	AAT3220IGY-2.85-T1
2.9V	SC59		AAT3220IGY-2.9-T1
3.0V	SC59	AIXYY	AAT3220IGY-3.0-T1
3.1V	SC59	IZXYY	AAT3220IGY-3.1-T1
3.3V	SC59	AJXYY	AAT3220IGY-3.3-T1
3.5V	SC59	IJXYY	AAT3220IGY-3.5-T1
1.8V	SOT-89	322018	AAT3220IQY-1.8-T1
2.0V	SOT-89	322020	AAT3220IQY-2.0-T1
2.3V	SOT-89	322023	AAT3220IQY-2.3-T1
2.4V	SOT-89	322024	AAT3220IQY-2.4-T1
2.5V	SOT-89	320025	AAT3220IQY-2.5-T1
2.7V	SOT-89	320027	AAT3220IQY-2.7-T1
2.8V	SOT-89	320028	AAT3220IQY-2.8-T1
2.85V	SOT-89	322285	AAT3220IQY-2.85-T1
2.9V	SOT-89		AAT3220IQY-2.9-T1
3.0V	SOT-89	322030	AAT3220IQY-3.0-T1
3.3V	SOT-89	322033	AAT3220IQY-3.3-T1
3.5V	SOT-89	322035	AAT3220IQY-3.5-T1



All AnalogicTech products are offered in Pb-free packaging. The term “Pb-free” means semiconductor products that are in compliance with current RoHS standards, including the requirement that lead not exceed 0.1% by weight in homogeneous materials. For more information, please visit our website at <http://www.analogictech.com/pbfree>.

1. XYY = assembly and date code.

2. Sample stock is generally held on all part numbers listed in **BOLD**.

Package Information

SC59

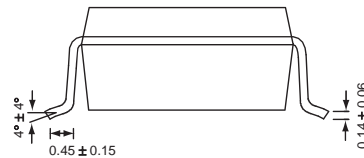
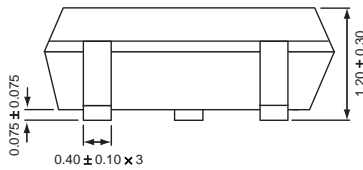
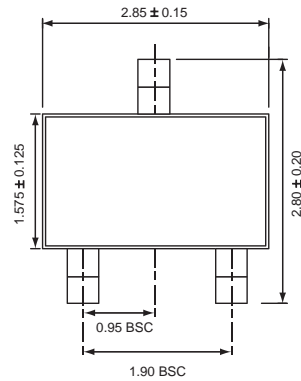

SOT-89

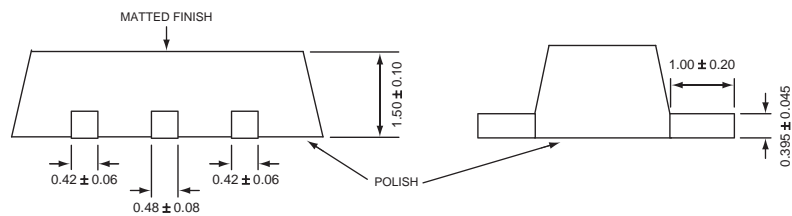
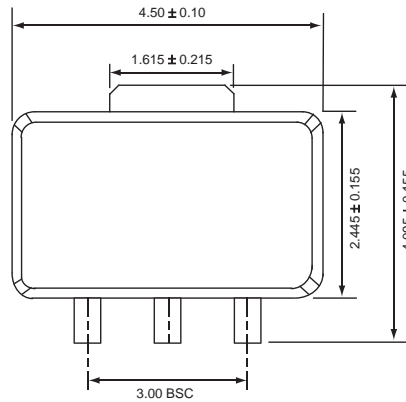

Dimensions shown in millimeters.

© Advanced Analogic Technologies, Inc.

AnalogicTech cannot assume responsibility for use of any circuitry other than circuitry entirely embodied in an AnalogicTech product. No circuit patent licenses, copyrights, mask work rights, or other intellectual property rights are implied. AnalogicTech reserves the right to make changes to their products or specifications or to discontinue any product or service without notice. Customers are advised to obtain the latest version of relevant information to verify, before placing orders, that information being relied on is current and complete. All products are sold subject to the terms and conditions of sale supplied at the time of order acknowledgement, including those pertaining to warranty, patent infringement, and limitation of liability. AnalogicTech warrants performance of its semiconductor products to the specifications applicable at the time of sale in accordance with AnalogicTech's standard warranty. Testing and other quality control techniques are utilized to the extent AnalogicTech deems necessary to support this warranty. Specific testing of all parameters of each device is not necessarily performed.

Advanced Analogic Technologies, Inc.
830 E. Arques Avenue, Sunnyvale, CA 94085
Phone (408) 737-4600
Fax (408) 737-4611

