

Variable Capacitance Diode

Description

The 1T408 is a variable capacitance diode designed for electronic tuning of wide-band CATV tuners using a super-small-miniature flat package (SSVC).

Features

- Super-small-miniature flat package
- Small series resistance 0.75Ω Max. (f = 470MHz)
- Large capacitance ratio 11.7 Typ. (C₂/C₂₅)
18.0 Typ. (C₁/C₂₈)
- Small leakage current 10nA Max. (V_R = 28V)
- Capacitance deviation in a matching group: within 2%

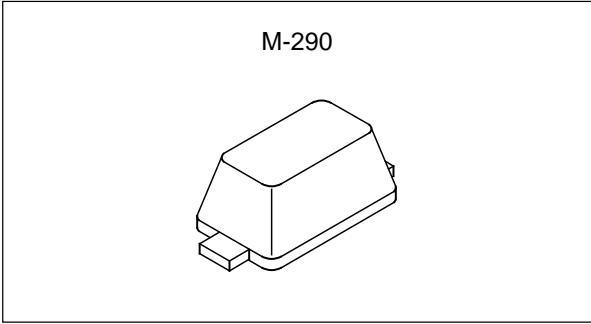

Applications

Electronic tuning of wide-band CATV tuners

Structure

Silicon epitaxial planar-type diode

Absolute Maximum Ratings (T_a = 25°C)

- Reverse voltage V_R 34 V
- Operating temperature T_{opr} -20 to +75 °C
- Storage temperature T_{stg} -65 to +150 °C

Electrical Characteristics

(T_a = 25°C)

Item	Symbol	Conditions	Min.	Typ.	Max.	Unit
Reverse current	I _R	V _R = 28V			10	nA
Diode capacitance	C ₂	V _R = 2V, f = 1MHz	29.46		35.46	pF
	C ₂₅	V _R = 25V, f = 1MHz	2.49		2.89	pF
Capacitance ratio	C ₂ /C ₂₅		11.0	11.7		
	C ₂₅ /C ₂₈		1.03			
Series resistance	r _s	C _D = 14pF, f = 470MHz			0.75	Ω
Capacitance deviation in a matching group	ΔC	V _R = 2 to 25V, f = 1MHz			2	%

Sony reserves the right to change products and specifications without prior notice. This information does not convey any license by any implication or otherwise under any patents or other right. Application circuits shown, if any, are typical examples illustrating the operation of the devices. Sony cannot assume responsibility for any problems arising out of the use of these circuits.

Example of Representative Characteristics

Diode capacitance vs. Reverse voltage

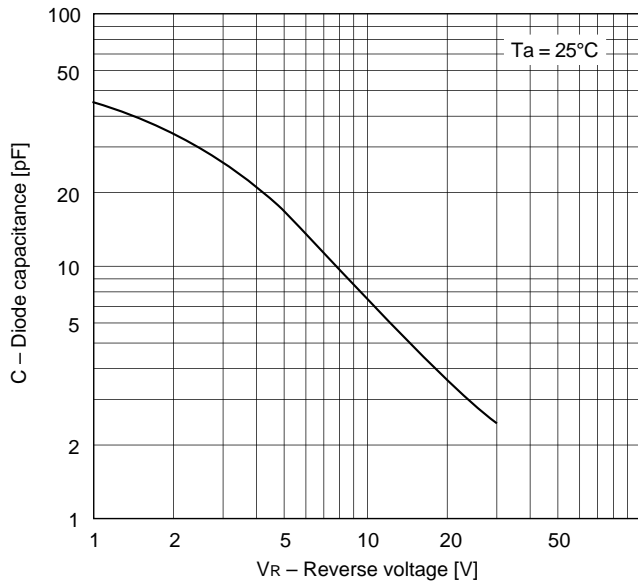

Reverse current vs. Ambient temperature

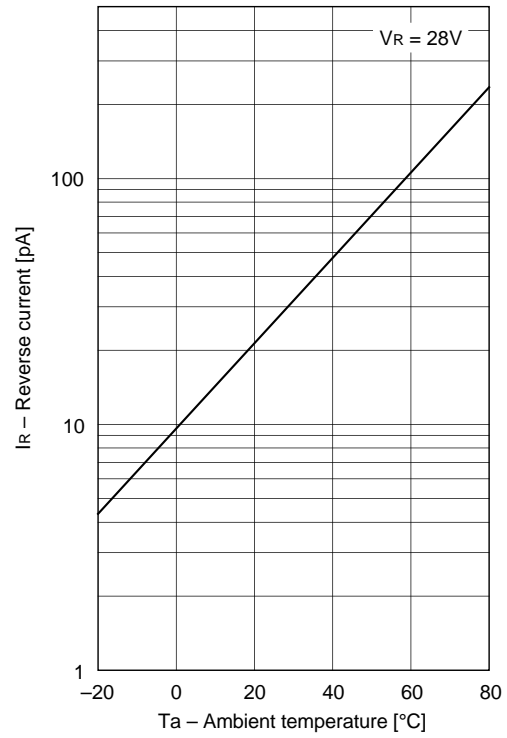

Forward voltage vs. Ambient temperature

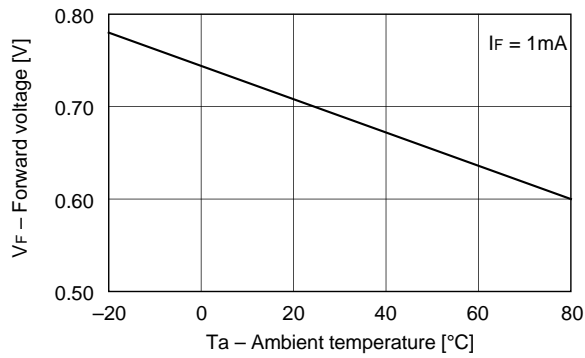

Reverse voltage vs. Ambient temperature

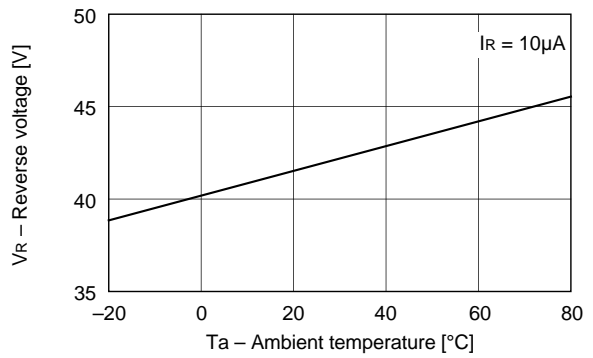

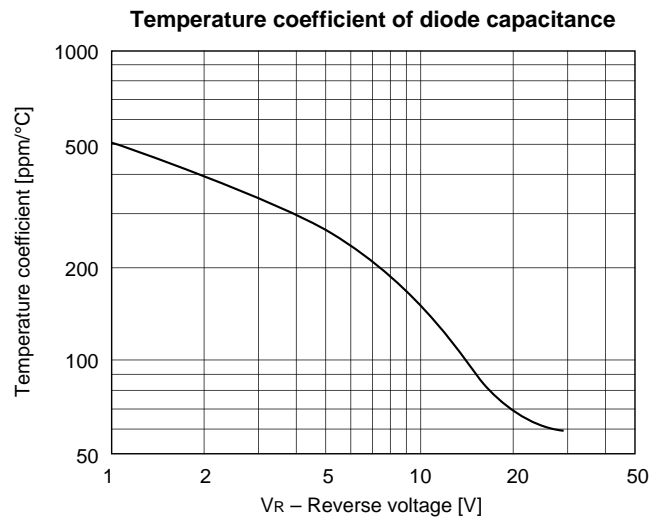
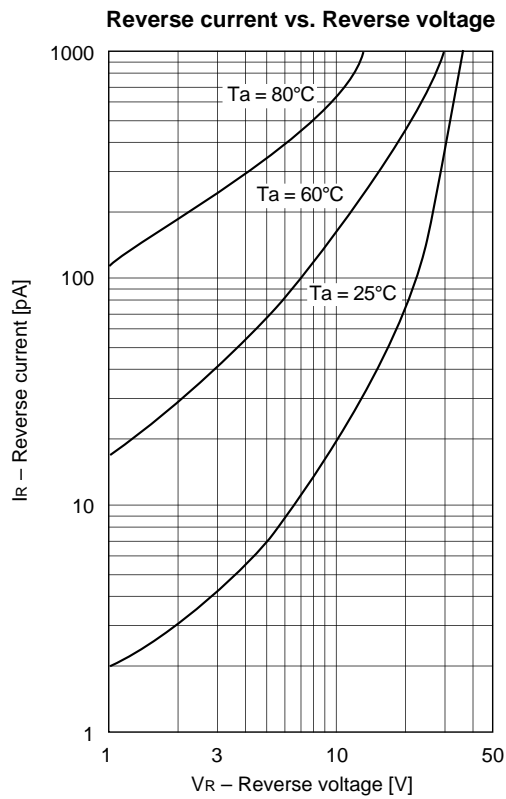
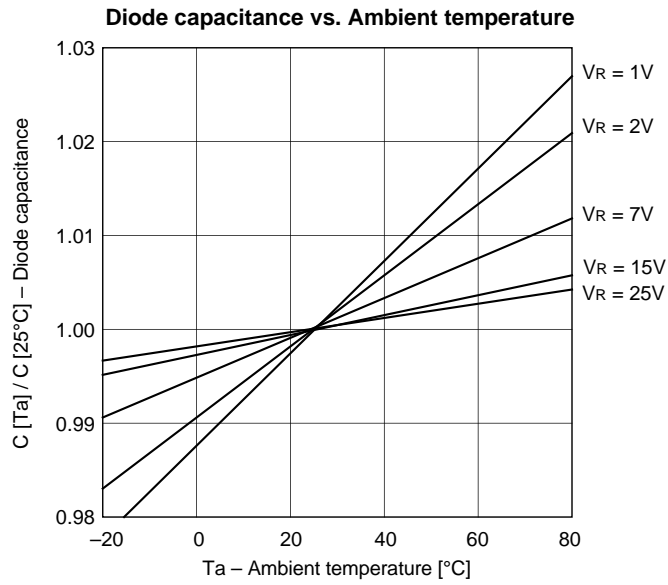

Package Outline

Unit: mm

M-290

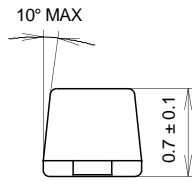
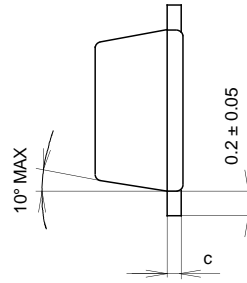
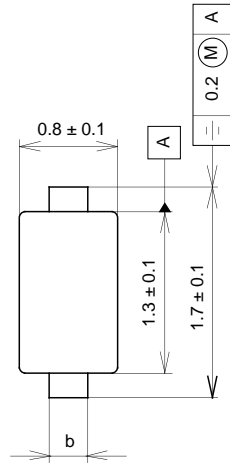

	BASE METAL	WITH PLATING
c	0.11 ± 0.005	0.11 ^{+0.05} / _{-0.01}
b	0.3 ± 0.025	0.3 ^{+0.05} / _{-0.02}

SONY CODE	M-290
EIAJ CODE	_____
JEDEC CODE	_____

PACKAGE MATERIAL	EPOXY RESIN
LEAD TREATMENT	SOLDER PLATING
LEAD MATERIAL	COPPER
PACKAGE WEIGHT	0.002g