



## 4M × 4 BANKS × 16 BIT SDRAM

### **Table of Contents-**

1. GENERAL DESCRIPTION .....	3
2. FEATURES .....	3
3. AVAILABLE PART NUMBER .....	3
4. PIN CONFIGURATION .....	4
5. PIN DESCRIPTION .....	5
6. BLOCK DIAGRAM .....	6
7. ELECTRICAL CHARACTERISTICS.....	7
Absolute Maximum Ratings.....	7
Recommended DC Operating Conditions .....	7
Capacitance.....	7
AC Characteristics and Operating Condition.....	8
DC Characteristics.....	9
8. OPERATION MODE .....	11
9. FUNCTIONAL DESCRIPTION .....	12
Power-up and Initialization .....	12
Programming Mode Register.....	12
Bank Activate Command .....	12
Read and Write Access Modes .....	12
Burst Read Command .....	13
Burst Write Command .....	13
Read Interrupted by a Read .....	13
Read Interrupted by a Write .....	13
Write Interrupted by a Write.....	13
Write Interrupted by a Read .....	13
Burst Stop Command .....	13
Addressing Sequence of Sequential Mode .....	14
Addressing Sequence of Interleave Mode .....	14
Auto Precharge Command .....	15
Precharge Command .....	15
Self Refresh Command .....	15
Power-down Mode.....	15
No Operation Command.....	16
Deselect Command .....	16
Clock Suspend Mode .....	16

10. TIMING WAVEFORMS.....	17
Command Input Timing .....	17
Read Timing .....	18
Control Timing of Input/Output Data.....	19
Mode Register Set Cycle.....	20
11. OPERATING TIMING EXAMPLE .....	21
Interleaved Bank Read (Burst Length = 4, CAS Latency = 3).....	21
Interleaved Bank Read (Burst Length = 4, CAS Latency = 3, Auto Precharge).....	22
Interleaved Bank Read (Burst Length = 8, CAS Latency = 3).....	23
Interleaved Bank Read (Burst Length = 8, CAS Latency = 3, Auto Precharge).....	24
Interleaved Bank Write (Burst Length = 8) .....	25
Interleaved Bank Write (Burst Length = 8, Auto Precharge) .....	26
Page Mode Read (Burst Length = 4, CAS Latency = 3) .....	27
Page Mode Read/Write (Burst Length = 8, CAS Latency = 3) .....	28
Auto Precharge Read (Burst Length = 4, CAS Latency = 3).....	29
Auto Precharge Write (Burst Length = 4) .....	30
Auto Refresh Cycle.....	31
Self Refresh Cycle .....	32
Burst Read and Single Write (Burst Length = 4, CAS Latency = 3).....	33
Power-down Mode.....	34
Auto Precharge Timing (Read Cycle).....	35
Auto Precharge Timing (Write Cycle) .....	36
Timing Chart of Read to Write Cycle .....	37
Timing Chart of Write to Read Cycle .....	37
Timing Chart of Burst Stop Cycle (Burst Stop Command) .....	38
Timing Chart of Burst Stop Cycle (Precharge Command) .....	38
CKE/DQM Input Timing (Write Cycle) .....	39
CKE/DQM Input Timing (Read Cycle) .....	40
Self Refresh/Power-down Mode Exit Timing.....	41
12. PACKAGE DIMENSION .....	43
54L TSOP (II)-400 mil.....	43



## 1. GENERAL DESCRIPTION

W982516BH is a high-speed synchronous dynamic random access memory (SDRAM), organized as 4M words × 4 banks × 16 bits. Using pipelined architecture and 0.175 μm process technology, W982516BH delivers a data bandwidth of up to 143M words per second (-7). To fully comply with the personal computer industrial standard, W982516BH is sorted into two speed grades: -7 and -75. The -7 is compliant to the 143 MHz/CL3 or PC133/CL2 specification, the -75 is compliant to the PC133/CL3 specification, for handheld device application, we also provide a low power option, the 75L grade, with Self Refresh Current under 1mA., and an industrial temperature option, the grade of 75I, which is guaranteed to support -40°C – 85°C.

Accesses to the SDRAM are burst oriented. Consecutive memory location in one page can be accessed at a burst length of 1, 2, 4, 8 or full page when a bank and row is selected by an ACTIVE command. Column addresses are automatically generated by the SDRAM internal counter in burst operation. Random column read is also possible by providing its address at each clock cycle. The multiple bank nature enables interleaving among internal banks to hide the precharging time.

By having a programmable Mode Register, the system can change burst length, latency cycle, interleave or sequential burst to maximize its performance. W982516BH is ideal for main memory in high performance applications.

## 2. FEATURES

- 3.3V ±0.3V Power Supply
- Up to 143 MHz Clock Frequency
- 4,194,304 Words × 4 Banks × 16 Bits Organization
- Self Refresh Mode: Standard and Low Power
- CAS Latency: 2 and 3
- Burst Length: 1, 2, 4, 8, and Full Page
- Burst Read, Single Writes Mode
- Byte Data Controlled by LDQM, UDQM
- Power-down Mode
- Auto Precharge and Controlled Precharge
- 8K Refresh Cycles/64 mS
- Interface: LVTTL
- Packaged in TSOP II 54-pin, 400 mil - 0.80

## 3. AVAILABLE PART NUMBER

PART NUMBER	SPEED GRADE	SELF REFRESH CURRENT (MAX.)	OPERATING TEMPERATURE
W982516BH-7	PC133/CL2	3 mA	0°C – 70°C
W982516BH-75	PC133/CL3	3 mA	0°C – 70°C
W982516BH75L	PC133/CL3	1 mA	0°C – 70°C
W982516BH75I	PC133/CL3	1 mA	-40°C – 85°C

## 4. PIN CONFIGURATION

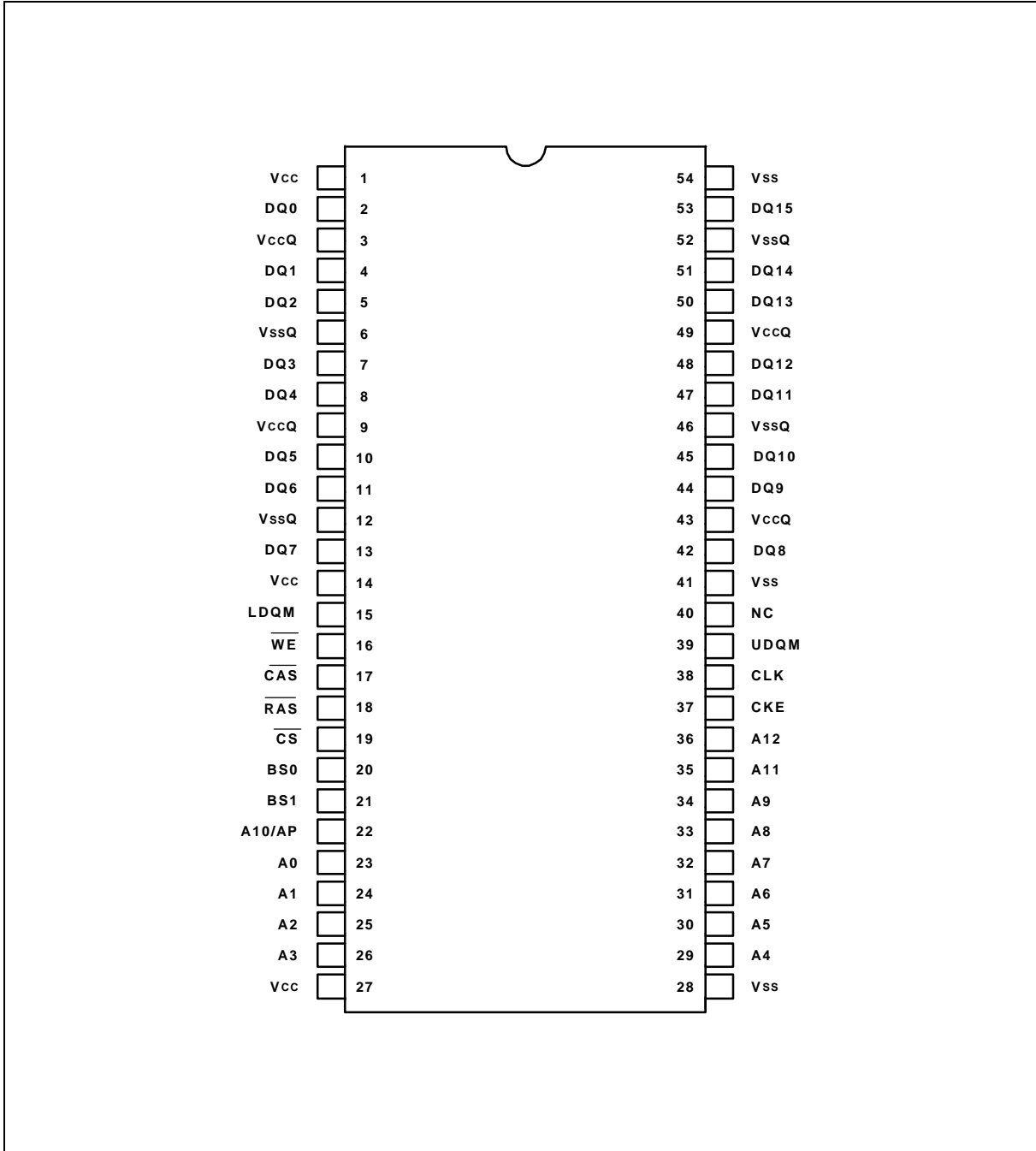

## 5. PIN DESCRIPTION

PIN NO.	PIN NAME	FUNCTION	DESCRIPTION
23 – 26, 22, 29 – 36	A0 – A12	Address	Multiplexed pins for row and column address. Row address: A0 – A12. Column address: A0 – A8.
20, 21	BS0, BS1	Bank Select	Select bank to activate during row address latch time, or bank to read/write during address latch time.
2, 4, 5, 7, 8, 10, 11, 13, 42, 44, 45, 47, 48, 50, 51, 53	DQ0 – DQ16	Data Input/Output	Multiplexed pins for data output and input.
19	$\overline{\text{CS}}$	Chip Select	Disable or enable the command decoder. When command decoder is disabled, new command is ignored and previous operation continues.
18	$\overline{\text{RAS}}$	Row Address Strobe	Command input. When sampled at the rising edge of the clock, $\overline{\text{RAS}}$ , $\overline{\text{CAS}}$ and $\overline{\text{WE}}$ define the operation to be executed.
17	$\overline{\text{CAS}}$	Column Address Strobe	Referred to $\overline{\text{RAS}}$
16	$\overline{\text{WE}}$	Write Enable	Referred to $\overline{\text{RAS}}$
15, 39	LDQM, UDQM	Input/Output Mask	The output buffer is placed at Hi-Z (with latency of 2) when DQM is sampled high in read cycle. In write cycle, sampling DQM high will block the write operation with zero latency.
38	CLK	Clock Inputs	System clock used to sample inputs on the rising edge of clock.
37	CKE	Clock Enable	CKE controls the clock activation and deactivation. When CKE is low, Power-down mode, Suspend mode, or Self Refresh mode is entered.
1, 14, 27	Vcc	Power (+3.3V)	Power for input buffers and logic circuit inside DRAM.
28, 41, 54	Vss	Ground	Ground for input buffers and logic circuit inside DRAM.
3, 9, 43, 49	VccQ	Power (+3.3V) for I/O Buffer	Separated power from Vcc, to improve DQ noise immunity.
6, 12, 46, 52	VssQ	Ground for I/O Buffer	Separated ground from Vss, to improve DQ noise immunity.
40	NC	No Connection	No connection

6. BLOCK DIAGRAM

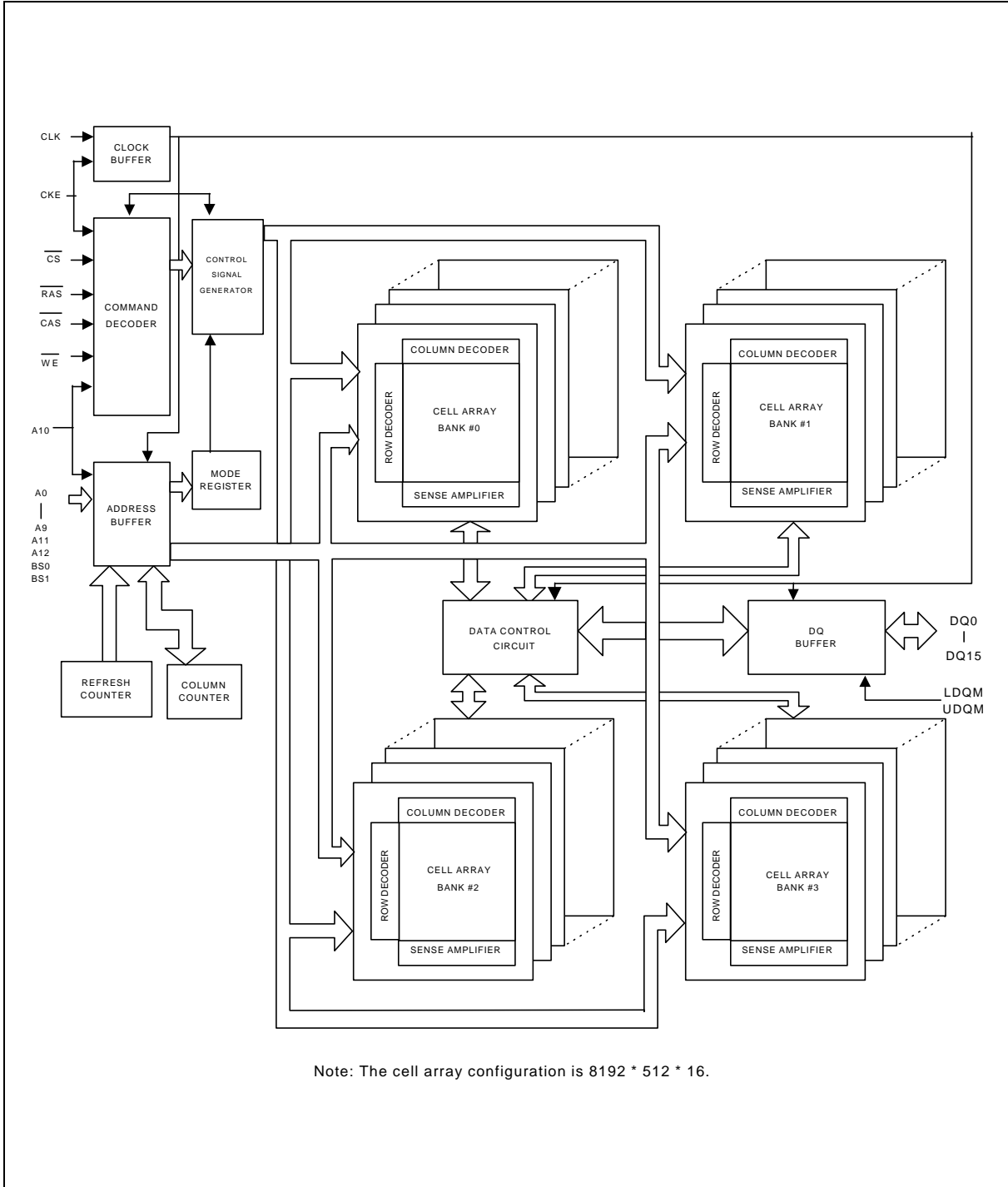



## 7. ELECTRICAL CHARACTERISTICS

### Absolute Maximum Ratings

PARAMETER	SYMBOL	RATING	UNIT	NOTE
Input, Output Voltage	V <sub>IN</sub> , V <sub>OUT</sub>	-0.3 – V <sub>CC</sub> + 0.3	V	1
Supply Voltage	V <sub>CC</sub> , V <sub>CCQ</sub>	-0.3 – 4.6	V	1
Operating Temperature (-7/-75/75L)	T <sub>OPR</sub>	0 – 70	°C	1
Operating Temperature (75I)	T <sub>OPR</sub>	-40 – 85	°C	1
Storage Temperature	T <sub>STG</sub>	-55 – 150	°C	1
Soldering Temperature (10s)	T <sub>SOLDER</sub>	260	°C	1
Power Dissipation	P <sub>D</sub>	1	W	1
Short Circuit Output Current	I <sub>OUT</sub>	50	mA	1

Note: Exposure to conditions beyond those listed under Absolute Maximum Ratings may adversely affect the life and reliability of the device.

### Recommended DC Operating Conditions

(T<sub>A</sub> = 0 to 70°C for -7/-75/75L, T<sub>A</sub> = -40 to 85°C for 75I)

PARAMETER	SYMBOL	MIN.	TYP.	MAX.	UNIT	NOTE
Supply Voltage	V <sub>CC</sub>	3.0	3.3	3.6	V	2
Supply Voltage (for I/O Buffer)	V <sub>CCQ</sub>	3.0	3.3	3.6	V	2
Input High Voltage	V <sub>IH</sub>	2.0	-	V <sub>CC</sub> + 0.3	V	2
Input Low Voltage	V <sub>IL</sub>	-0.3	-	0.8	V	2

Note: V<sub>IH</sub>(max.) = V<sub>CC</sub>/V<sub>CCQ</sub>+1.2V for pulse width ≤ 5 nS  
 V<sub>IL</sub>(min.) = V<sub>SS</sub>/V<sub>SSQ</sub>-1.2V for pulse width ≤ 5 nS

### Capacitance

(V<sub>CC</sub> = 3.3V, f = 1 MHz, T<sub>A</sub> = 25°C)

PARAMETER	SYMBOL	MIN.	MAX.	UNIT
Input Capacitance (A0 to A12, BS0, BS1, $\overline{CS}$ , $\overline{RAS}$ , $\overline{CAS}$ , $\overline{WE}$ , LDQM, UDQM, CKE)	C <sub>I</sub>	-	3.8	pF
Input Capacitance (CLK)	C <sub>CLK</sub>	-	3.5	pF
Input/Output Capacitance	C <sub>IO</sub>	-	6.5	pF

Note: These parameters are periodically sampled and not 100% tested.

## AC Characteristics and Operating Condition

(V<sub>CC</sub> = 3.3V ±0.3V, T<sub>A</sub> = 0 to 70°C for -7/-75/75L, T<sub>A</sub> = -40 to 85°C for 75I ; Notes: 5, 6, 7, 8)

PARAMETER	SYM.	-7 (PC133, CL2)		-75/75L/75I (PC133, CL3)		UNIT	
		MIN.	MAX.	MIN.	MAX.		
Ref/Active to Ref/Active Command Period	t <sub>RC</sub>	56		65		nS	
Active to Precharge Command Period	t <sub>RAS</sub>	40	100000	45	100000		
Active to Read/Write Command Delay Time	t <sub>RCD</sub>	15		20			
Read/Write(a) to Read/Write(b) Command Period	t <sub>CCD</sub>	1		1		Cycle	
Precharge to Active Command Period	t <sub>RP</sub>	15		20		nS	
Active(a) to Active(b) Command Period	t <sub>RRD</sub>	15		15			
Write Recovery Time	CL* = 2 CL* = 3	t <sub>WR</sub>		10			
		7		7.5			
CLK Cycle Time	CL* = 2 CL* = 3	t <sub>CK</sub>	7.5	1000	10		1000
		7	1000	7.5	1000		
CLK High Level Width	t <sub>CH</sub>	2.5		2.5			
CLK Low Level Width	t <sub>CL</sub>	2.5		2.5			
Access Time from CLK	CL* = 2 CL* = 3	t <sub>AC</sub>		5.4			6
				5.4			5.4
Output Data Hold Time	t <sub>OH</sub>	3		3			
Output Data High Impedance Time	t <sub>HZ</sub>	3	7	3	7.5		
Output Data Low Impedance Time	t <sub>LZ</sub>	0		0			
Power-down Mode Entry Time	t <sub>SB</sub>	0	7	0	7.5		
Transition Time of CLK (Rise and Fall)	t <sub>T</sub>	0.5	10	0.5	10		
Data-in Set-up Time	t <sub>DS</sub>	1.5		1.5			
Data-in Hold Time	t <sub>DH</sub>	0.8		0.8			
Address Set-up Time	t <sub>AS</sub>	1.5		1.5			
Address Hold Time	t <sub>AH</sub>	0.8		0.8			
CKE Set-up Time	t <sub>CKS</sub>	1.5		1.5			
CKE Hold Time	t <sub>CKH</sub>	0.8		0.8			
Command Set-up Time	t <sub>CMS</sub>	1.5		1.5			
Command Hold Time	t <sub>CMS</sub>	0.8		0.8			
Refresh Time	t <sub>REF</sub>		64		64	mS	
Mode Register Set Cycle Time	t <sub>RSC</sub>	14		15		nS	

\*CL = CAS Latency





## DC Characteristics

(V<sub>CC</sub> = 3.3V ±0.3V, T<sub>A</sub> = 0 to 70°C for -7/-75/75L, T<sub>A</sub> = -40 to 85°C for 75I)

PARAMETER		SYM.	-7 (PC133, CL2)		-75/75L/75I (PC133, CL3)		UNIT	NOTES
			MIN.	MAX.	MIN.	MAX.		
Operating Current t <sub>CK</sub> = min., t <sub>RC</sub> = min. Active precharge command cycling without burst operation	1 Bank Operation	I <sub>CC1</sub>		80		75	mA	3
	Standby Current t <sub>CK</sub> = min, $\overline{CS}$ = V <sub>IH</sub> V <sub>IH/L</sub> = V <sub>IH</sub> (min.)/V <sub>IL</sub> (max.) Bank: Inactive state	CKE = V <sub>IH</sub>	I <sub>CC2</sub>		40			35
Standby Current CLK = V <sub>IL</sub> , $\overline{CS}$ = V <sub>IH</sub> V <sub>IH/L</sub> = V <sub>IH</sub> (min.)/V <sub>IL</sub> (max.) BANK: Inactive state	CKE = V <sub>IL</sub> (Power-down mode)	I <sub>CC2P</sub>		1		1		3
	CKE = V <sub>IH</sub>	I <sub>CC2S</sub>		10		10		
No Operating Current t <sub>CK</sub> = min., $\overline{CS}$ = V <sub>IH</sub> (min.) BANK: Active state (4 banks)	CKE = V <sub>IL</sub> (Power-down mode)	I <sub>CC2PS</sub>		1		1		
	CKE = V <sub>IH</sub>	I <sub>CC3</sub>		60		55		
Burst Operating Current t <sub>CK</sub> = min. Read/ Write command cycling	CKE = V <sub>IL</sub> (Power-down mode)	I <sub>CC3P</sub>		10		10		
		I <sub>CC4</sub>		100		95		3, 4
Auto Refresh Current t <sub>CK</sub> = min. Auto refresh command cycling		I <sub>CC5</sub>		170		160		3
Self Refresh Current Self Refresh Mode CKE = 0.2V	Standard (-7/-75)	I <sub>CC6L</sub>		3		3		
	Low Power (75L/75I)			-		1		

PARAMETER	SYMBOL	MIN.	MAX.	UNIT	NOTES
Input Leakage Current (0V ≤ V <sub>IN</sub> ≤ V <sub>CC</sub> , all other pins not under test = 0V)	I <sub>I(L)</sub>	-5	5	μA	
Output Leakage Current (Output disable, 0V ≤ V <sub>OUT</sub> ≤ V <sub>CCQ</sub> )	I <sub>O(L)</sub>	-5	5	μA	
LVTTL Output "H" Level Voltage (I <sub>OUT</sub> = -2 mA)	V <sub>OH</sub>	2.4	-	V	
LVTTL Output "L" Level Voltage (I <sub>OUT</sub> = 2 mA)	V <sub>OL</sub>	-	0.4	V	

Notes:

1. Operation exceeds "ABSOLUTE MAXIMUM RATING" may cause permanent damage to the devices.
2. All voltages are referenced to VSS
3. These parameters depend on the cycle rate and listed values are measured at a cycle rate with the minimum values of  $t_{CK}$  and  $t_{RC}$ .
4. These parameters depend on the output loading conditions. Specified values are obtained with output open.
5. Power-up sequence is further described in the "Functional Description" section.
6. AC Testing Conditions

Output Reference Level	1.4V/1.4V
Output Load	See diagram below
Input Signal Levels	2.4V/0.4V
Transition Time (Rise and Fall) of Input Signal	2 nS
Input Reference Level	1.4V

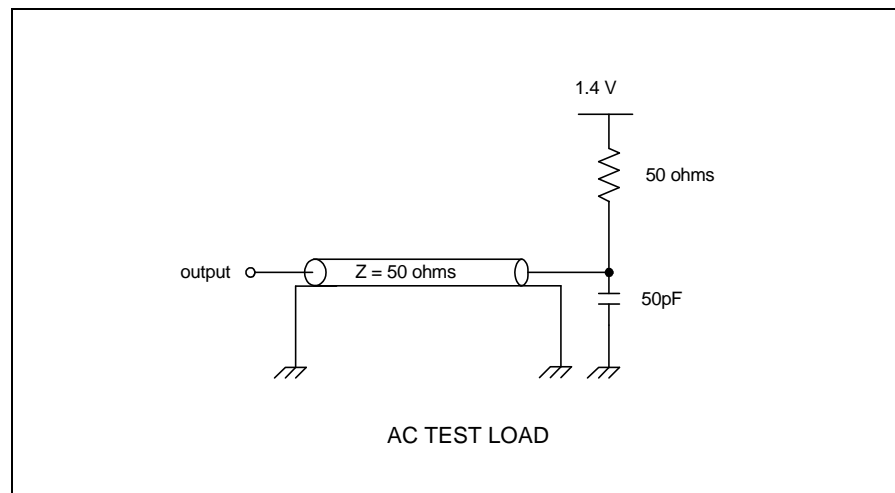

7. Transition times are measured between  $V_{IH}$  and  $V_{IL}$ .
8.  $t_{HZ}$  defines the time at which the outputs achieve the open circuit condition and is not referenced to output level.

## 8. OPERATION MODE

Fully synchronous operations are performed to latch the commands at the positive edges of CLK. Table 1 shows the truth table for the operation commands.

**Table 1 Truth Table (Note (1) , (2))**

COMMAND	DEVICE STATE	CKEN-1	CKEN	DQM	BS0, 1	A10	A0 – A9 A11, A12	$\overline{\text{CS}}$	$\overline{\text{RAS}}$	$\overline{\text{CAS}}$	$\overline{\text{WE}}$
Bank Active	Idle	H	x	x	v	v	v	L	L	H	H
Bank Precharge	Any	H	x	x	v	L	x	L	L	H	L
Precharge All	Any	H	x	x	x	H	x	L	L	H	L
Write	Active (3)	H	x	x	v	L	v	L	H	L	L
Write with Auto Precharge	Active (3)	H	x	x	v	H	v	L	H	L	L
Read	Active (3)	H	x	x	v	L	v	L	H	L	H
Read with Auto Precharge	Active (3)	H	x	x	v	H	v	L	H	L	H
Mode Register Set	Idle	H	x	x	v	v	v	L	L	L	L
No-operation	Any	H	x	x	x	x	x	L	H	H	H
Burst Stop	Active (4)	H	x	x	x	x	x	L	H	H	L
Device Deselect	Any	H	x	x	x	x	x	H	x	x	x
Auto Refresh	Idle	H	H	x	x	x	x	L	L	L	H
Self Refresh Entry	Idle	H	L	x	x	x	x	L	L	L	H
Self Refresh Exit	Idle (S.R.)	L L	H H	x x	x x	x x	x x	H L	x H	x H	x x
Clock Suspend Mode Entry	Active	H	L	x	x	x	x	x	x	x	x
Power-down Mode Entry	Idle Active (5)	H H	L L	x x	x x	x x	x x	H L	x H	x H	x x
Clock Suspend Mode Exit	Active	L	H	x	x	x	x	x	x	x	x
Power-down Mode Exit	Any (Power-down)	L L	H H	x x	x x	x x	x x	H L	x H	x H	x x
Data Write/Output Enable	Active	H	x	L	x	x	x	x	x	x	x
Data Write/Output Disable	Active	H	x	H	x	x	x	x	x	x	x

Notes:

- (1) v = valid    x = Don't care    L = Low Level    H = High Level
- (2) CKEn signal is input level when commands are provided.  
CKEn-1 signal is the input level one clock cycle before the command is issued.
- (3) These are state of bank designated by BS0, BS1 signals.
- (4) Device state is full page burst operation.
- (5) Power-down Mode can not be entered in the burst cycle.  
When this command asserts in the burst cycle, device state is clock suspend mode.



## 9. FUNCTIONAL DESCRIPTION

### Power-up and Initialization

The default Power-up state of the mode register is unspecified. The following Power-up and initialization sequence need to be followed to guarantee the device being preconditioned to each user specific needs.

During Power-up, all Vcc and VccQ pins must be ramp up simultaneously to the specified voltage when the input signals are held in the "NOP" state. The Power-up voltage must not exceed Vcc +0.3V on any of the input pins or Vcc supplies. After Power-up, an initial pause of 200  $\mu$ S is required followed by a precharge of all banks using the precharge command. To prevent data contention on the DQ bus during Power-up, it is required that the DQM and CKE pins be held high during the initial pause period. Once all banks have been precharged, the Mode Register Set Command must be issued to initialize the Mode Register. An additional eight Auto Refresh cycles (CBR) are also required before or after programming the Mode Register to ensure proper subsequent operation.

### Programming Mode Register

After initial Power-up, the Mode Register Set Command must be issued for proper device operation. All banks must be in a precharged state and CKE must be high at least one cycle before the Mode Register Set Command can be issued. The Mode Register Set Command is activated by the low signals of RAS, CAS, CS and WE at the positive edge of the clock. The address input data during this cycle defines the parameters to be set as shown in the Mode Register Operation table. A new command may be issued following the mode register set command once a delay equal to  $t_{RSC}$  has elapsed. Please refer to the next page for Mode Register Set Cycle and Operation Table.

### Bank Activate Command

The Bank Activate command must be applied before any Read or Write operation can be executed. The operation is similar to  $\overline{\text{RAS}}$  activate in EDO DRAM. The delay from when the Bank Activate command is applied to when the first read or write operation can begin must not be less than the RAS to CAS delay time ( $t_{RCD}$ ). Once a bank has been activated it must be precharged before another Bank Activate command can be issued to the same bank. The minimum time interval between successive Bank Activate commands to the same bank is determined by the RAS cycle time of the device ( $t_{RC}$ ). The minimum time interval between interleaved Bank Activate commands (Bank A to Bank B and vice versa) is the Bank to Bank delay time ( $t_{RRD}$ ). The maximum time that each bank can be held active is specified as  $t_{RAS}(\text{max})$ .

### Read and Write Access Modes

After a bank has been activated, a read or write cycle can be followed. This is accomplished by setting RAS high and CAS low at the clock rising edge after minimum of  $t_{RCD}$  delay. WE pin voltage level defines whether the access cycle is a read operation (WE high), or a write operation (WE low). The address inputs determine the starting column address.

Reading or writing to a different row within an activated bank requires the bank be precharged and a new Bank Activate command be issued. When more than one bank is activated, interleaved bank Read or Write operations are possible. By using the programmed burst length and alternating the access and precharge operations between multiple banks, seamless data access operation among many different pages can be realized. Read or Write Commands can also be issued to the same bank or between active banks on every clock cycle.



## **Burst Read Command**

The Burst Read command is initiated by applying logic low level to CS and CAS while holding RAS and WE high at the rising edge of the clock. The address inputs determine the starting column address for the burst. The Mode Register sets type of burst (sequential or interleave) and the burst length (1, 2, 4, 8, full page) during the Mode Register Set Up cycle. Table 2 and 3 in the next page explain the address sequence of interleave mode and sequential mode.

## **Burst Write Command**

The Burst Write command is initiated by applying logic low level to CS, CAS and WE while holding RAS high at the rising edge of the clock. The address inputs determine the starting column address. Data for the first burst write cycle must be applied on the DQ pins on the same clock cycle that the Write Command is issued. The remaining data inputs must be supplied on each subsequent rising clock edge until the burst length is completed. Data supplied to the DQ pins after burst finishes will be ignored.

## **Read Interrupted by a Read**

A Burst Read may be interrupted by another Read Command. When the previous burst is interrupted, the remaining addresses are overridden by the new read address with the full burst length. The data from the first Read Command continues to appear on the outputs until the CAS latency from the interrupting Read Command is satisfied.

## **Read Interrupted by a Write**

To interrupt a burst read with a Write Command, DQM may be needed to place the DQs (output drivers) in a high impedance state to avoid data contention on the DQ bus. If a Read Command will issue data on the first and second clocks cycles of the write operation, DQM is needed to insure the DQs are tri-stated. After that point the Write Command will have control of the DQ bus and DQM masking is no longer needed.

## **Write Interrupted by a Write**

A burst write may be interrupted before completion of the burst by another Write Command. When the previous burst is interrupted, the remaining addresses are overridden by the new address and data will be written into the device until the programmed burst length is satisfied.

## **Write Interrupted by a Read**

A Read Command will interrupt a burst write operation on the same clock cycle that the Read Command is activated. The DQs must be in the high impedance state at least one cycle before the new read data appears on the outputs to avoid data contention. When the Read Command is activated, any residual data from the burst write cycle will be ignored.

## **Burst Stop Command**

A Burst Stop Command may be used to terminate the existing burst operation but leave the bank open for future Read or Write Commands to the same page of the active bank, if the burst length is full page. Use of the Burst Stop Command during other burst length operations is illegal. The Burst Stop Command is defined by having RAS and CAS high with CS and WE low at the rising edge of the clock. The data DQs go to a high impedance state after a delay which is equal to the CAS Latency in a burst



read cycle interrupted by Burst Stop. If a Burst Stop Command is issued during a full page burst write operation, then any residual data from the burst write cycle will be ignored.

## Addressing Sequence of Sequential Mode

A column access is performed by increasing the address from the column address which is input to the device. The disturb address is varied by the Burst Length as shown in Table 2.

**Table 2 Address Sequence of Sequential Mode**

DATA	ACCESS ADDRESS	BURST LENGTH
Data 0	n	BL = 2 (disturb address is A0) No address carry from A0 to A1
Data 1	n + 1	
Data 2	n + 2	BL = 4 (disturb addresses are A0 and A1) No address carry from A1 to A2
Data 3	n + 3	
Data 4	n + 4	BL = 8 (disturb addresses are A0, A1 and A2) No address carry from A2 to A3
Data 5	n + 5	
Data 6	n + 6	
Data 7	n + 7	

## Addressing Sequence of Interleave Mode

A column access is started in the input column address and is performed by inverting the address bit in the sequence shown in Table 3.

**Table 3 Address Sequence of Interleave Mode**

DATA	ACCESS ADDRESS	BURST LENGTH
Data 0	A8 A7 A6 A5 A4 A3 A2 A1 A0	BL = 2
Data 1	A8 A7 A6 A5 A4 A3 A2 A1 $\overline{A0}$	
Data 2	A8 A7 A6 A5 A4 A3 A2 $\overline{A1}$ A0	BL = 4
Data 3	A8 A7 A6 A5 A4 A3 A2 $\overline{A1}$ $\overline{A0}$	
Data 4	A8 A7 A6 A5 A4 A3 $\overline{A2}$ A1 A0	BL = 8
Data 5	A8 A7 A6 A5 A4 A3 $\overline{A2}$ A1 $\overline{A0}$	
Data 6	A8 A7 A6 A5 A4 A3 $\overline{A2}$ $\overline{A1}$ A0	
Data 7	A8 A7 A6 A5 A4 A3 $\overline{A2}$ $\overline{A1}$ $\overline{A0}$	

## Auto Precharge Command

If A10 is set to high when the Read or Write Command is issued, then the auto precharge function is entered. During auto precharge, a Read Command will execute as normal with the exception that the active bank will begin to precharge automatically before all burst read cycles have been completed. Regardless of burst length, it will begin a certain number of clocks prior to the end of the scheduled burst cycle. The number of clocks is determined by CAS latency.

A Read or Write Command with auto precharge can not be interrupted before the entire burst operation is completed. Therefore, use of a Read, Write, or Precharge Command is prohibited during a read or write cycle with auto precharge. Once the precharge operation has started, the bank cannot be reactivated until the Precharge time ( $t_{RP}$ ) has been satisfied. Issue of Auto precharge command is illegal if the burst is set to full page length. If A10 is high when a Write Command is issued, the Write with Auto precharge function is initiated. The SDRAM automatically enters the precharge operation one clock delay from the last burst write cycle. This delay is referred to as Write  $t_{WR}$ . The bank undergoing auto precharge can not be reactivated until  $t_{WR}$  and  $t_{RP}$  are satisfied. This is referred to as  $t_{DAL}$ , Data-in to Active delay ( $t_{DAL} = t_{WR} + t_{RP}$ ). When using the Auto precharge Command, the interval between the Bank Activate Command and the beginning of the internal precharge operation must satisfy  $t_{RAS}$  (min).

## Precharge Command

The Precharge Command is used to precharge or close a bank that has been activated. The Precharge Command is entered when CS, RAS and WE are low and CAS is high at the rising edge of the clock. The Precharge Command can be used to precharge each bank separately or all banks simultaneously. Three address bits, A10, BS0, and BS1, are used to define which bank(s) is to be precharged when the command is issued. After the Precharge Command is issued, the precharged bank must be reactivated before a new read or write access can be executed. The delay between the Precharge Command and the Activate Command must be greater than or equal to the Precharge time ( $t_{RP}$ ).

## Self Refresh Command

The Self Refresh Command is defined by having CS, RAS, CAS and CKE held low with WE high at the rising edge of the clock. All banks must be idle prior to issuing the Self Refresh Command. Once the command is registered, CKE must be held low to keep the device in Self Refresh mode. When the SDRAM has entered Self Refresh mode all of the external control signals, except CKE, are disabled. The clock is internally disabled during Self Refresh Operation to save power. The device will exit Self Refresh operation after CKE is returned high. A minimum delay time is required when the device exits Self Refresh Operation and before the next command can be issued. This delay is equal to the  $t_{AC}$  cycle time plus the Self Refresh exit time.

If, during normal operation, AUTO REFRESH cycles are issued in bursts (as opposed to being evenly distributed), a burst of 8,192 AUTO REFRESH cycles should be completed just prior to entering and just after exiting the self refresh mode.

## Power-down Mode

The Power-down mode is initiated by holding CKE low. All of the receiver circuits except CKE are gated off to reduce the power. The Power-down mode does not perform any refresh operations, therefore the device can not remain in Power-down mode longer than the Refresh period ( $t_{REF}$ ) of the device.



The Power-down mode is exited by bringing CKE high. When CKE goes high, a No Operation Command is required on the next rising clock edge, depending on  $t_{CK}$ . The input buffers need to be enabled with CKE held high for a period equal to  $t_{CKS}(\text{min}) + t_{CK}(\text{min})$ .

## No Operation Command

The No Operation Command should be used in cases when the SDRAM is in a idle or a wait state to prevent the SDRAM from registering any unwanted commands between operations. A No Operation Command is registered when CS is low with RAS, CAS, and WE held high at the rising edge of the clock. A No Operation Command will not terminate a previous operation that is still executing, such as a burst read or write cycle.

## Deselect Command

The Deselect Command performs the same function as a No Operation Command. Deselect Command occurs when CS is brought high, the RAS, CAS, and WE signals become don't cares.

## Clock Suspend Mode

During normal access mode, CKE must be held high enabling the clock. When CKE is registered low while at least one of the banks is active, Clock Suspend Mode is entered. The Clock Suspend mode deactivates the internal clock and suspends any clocked operation that was currently being executed. There is a one clock delay between the registration of CKE low and the time at which the SDRAM operation suspends. While in Clock Suspend mode, the SDRAM ignores any new commands that are issued. The Clock Suspend mode is exited by bringing CKE high. There is a one clock cycle delay from when CKE returns high to when Clock Suspend mode is exited.



10. TIMING WAVEFORMS

Command Input Timing

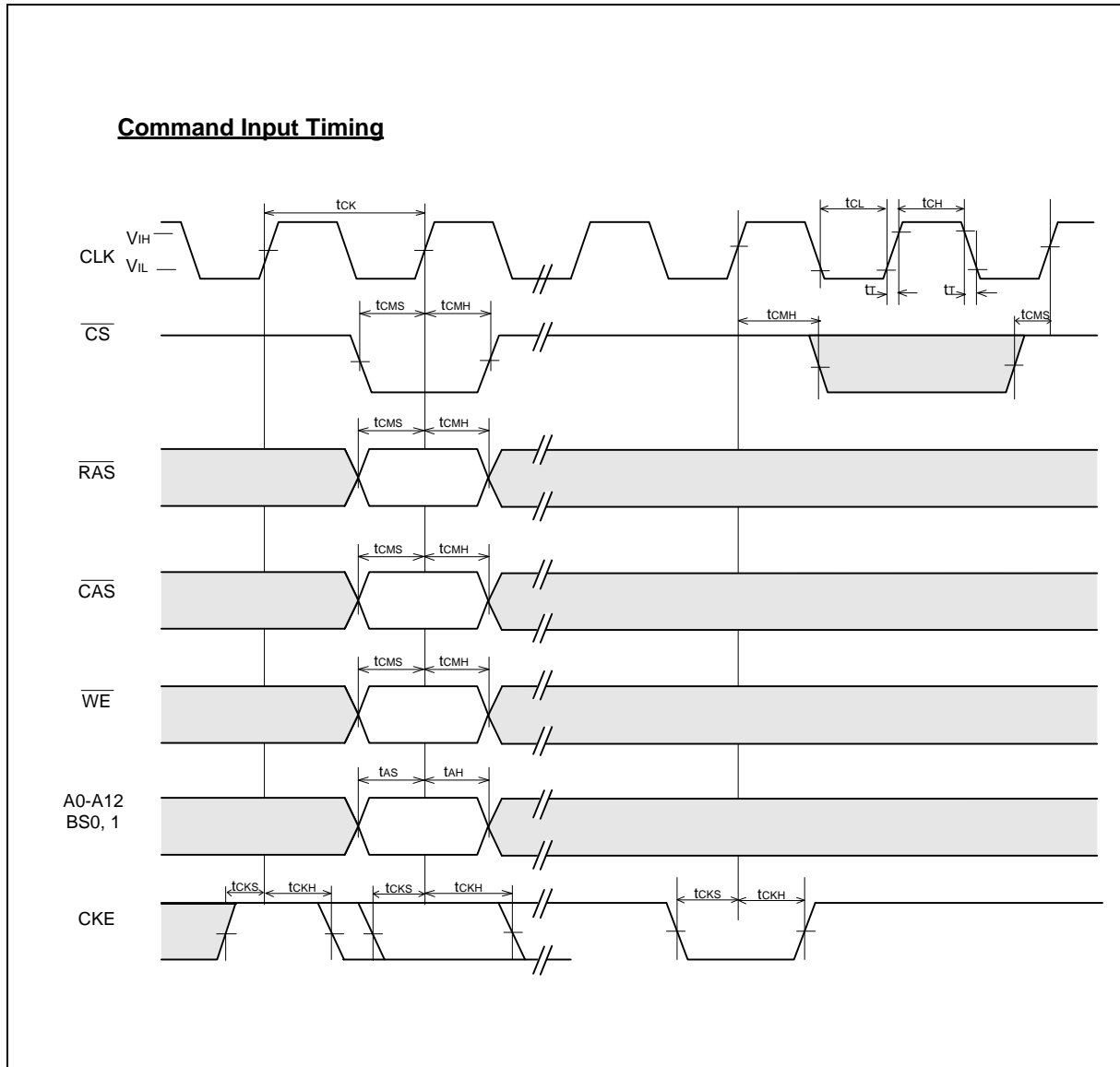

Timing Waveforms, continued

**Read Timing**

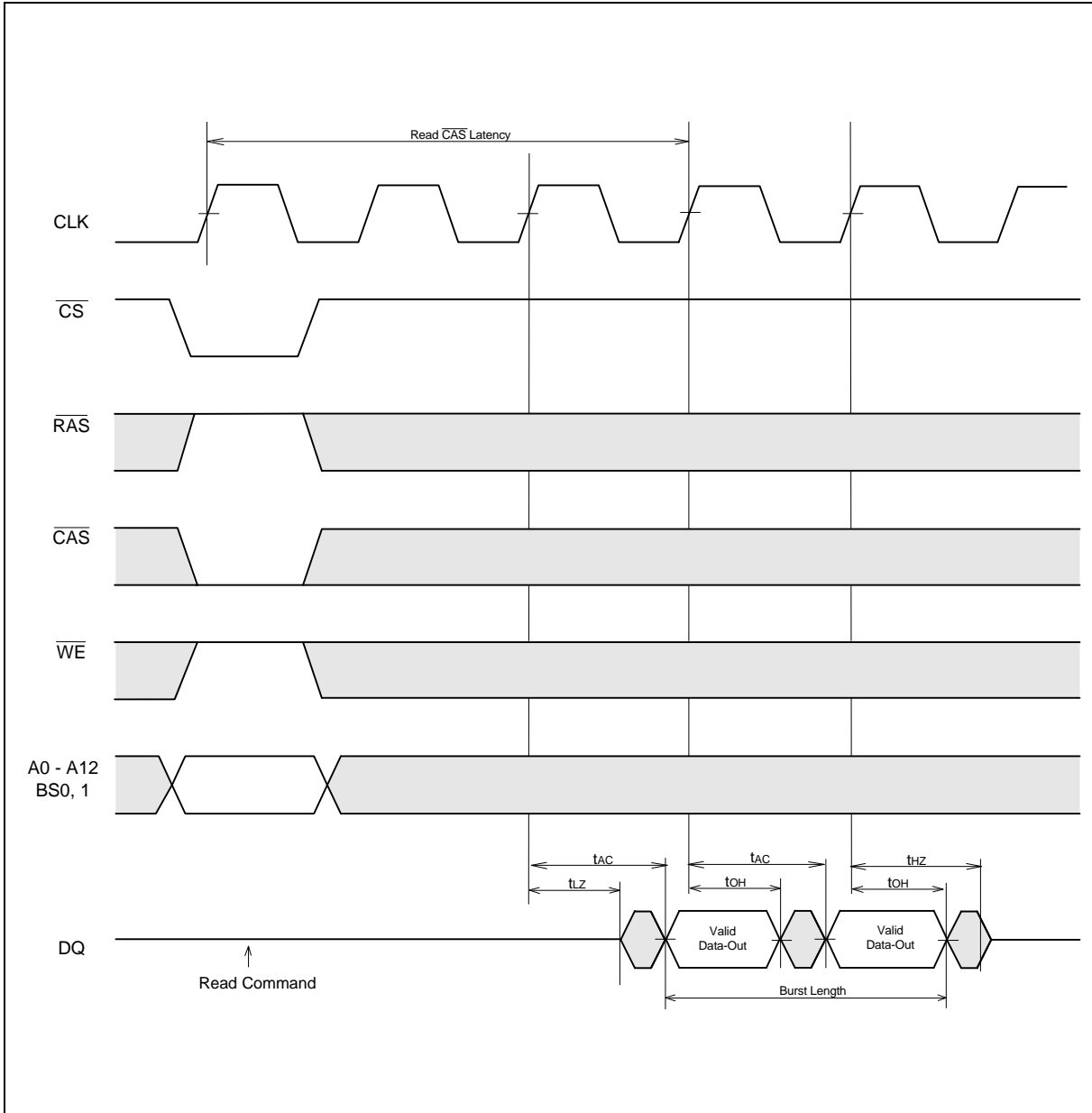

Timing Waveforms, continued

## Control Timing of Input/Output Data

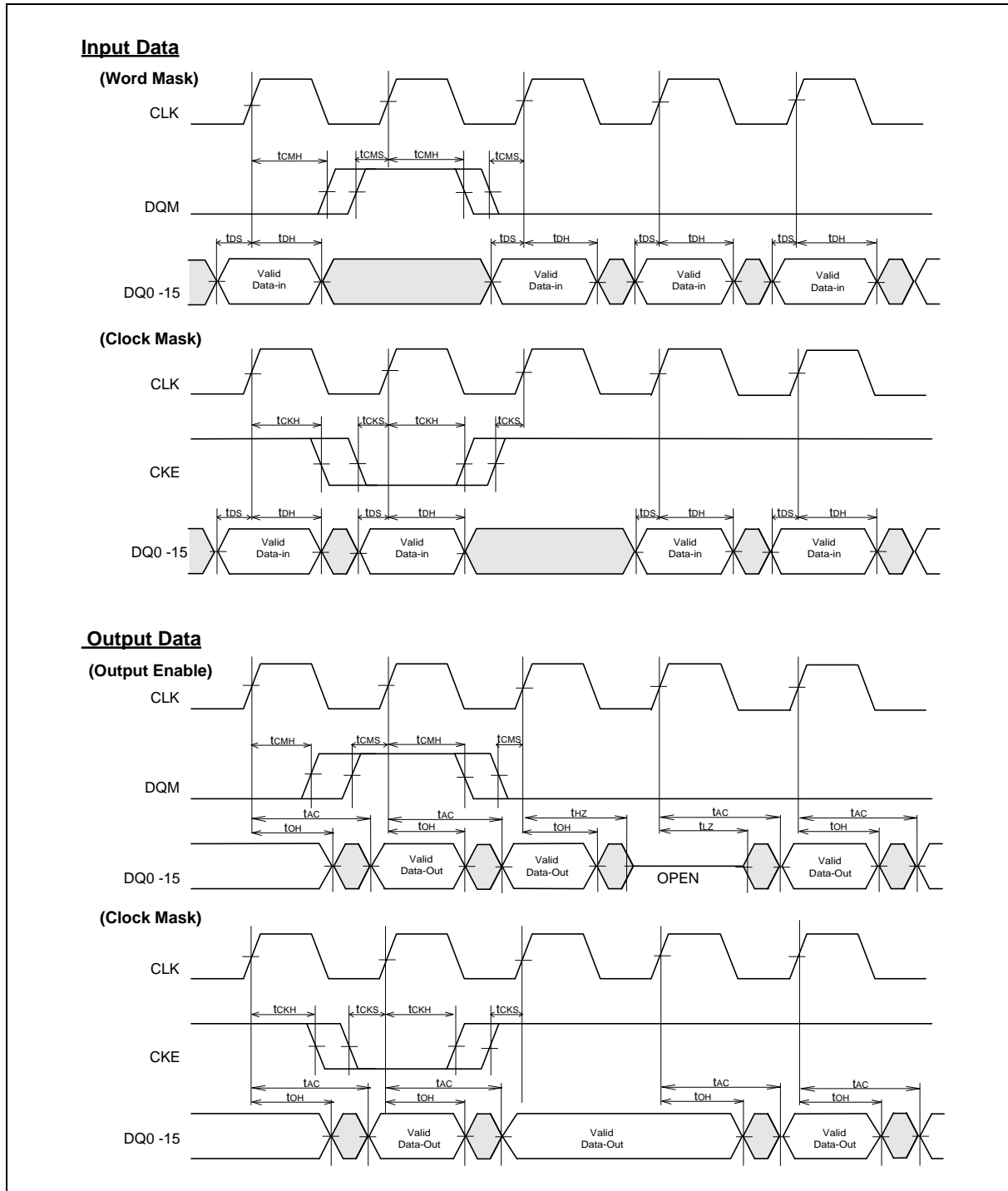



Timing Waveforms, continued

**Mode Register Set Cycle**

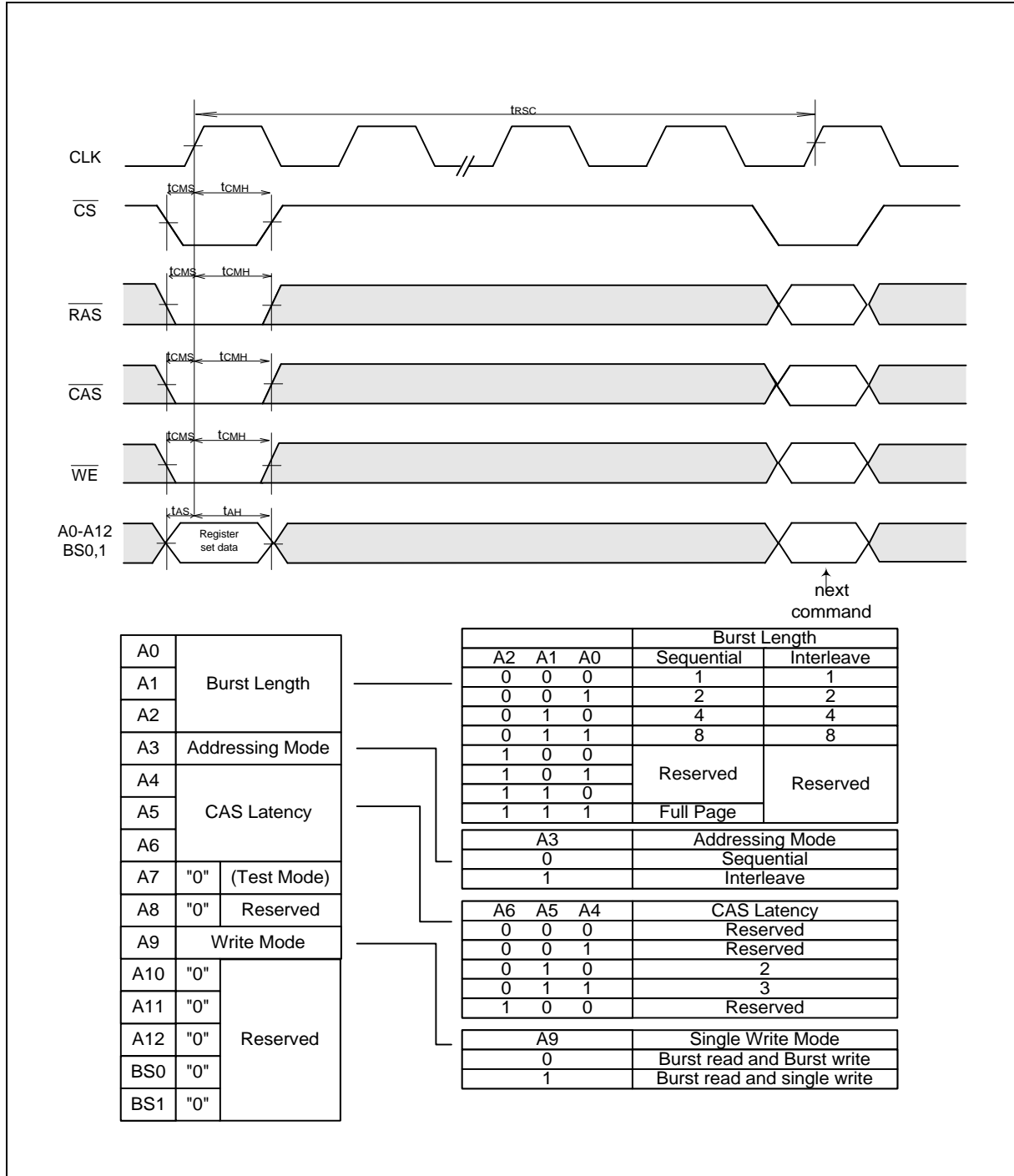



### 11. OPERATING TIMING EXAMPLE

#### Interleaved Bank Read (Burst Length = 4, CAS Latency = 3)

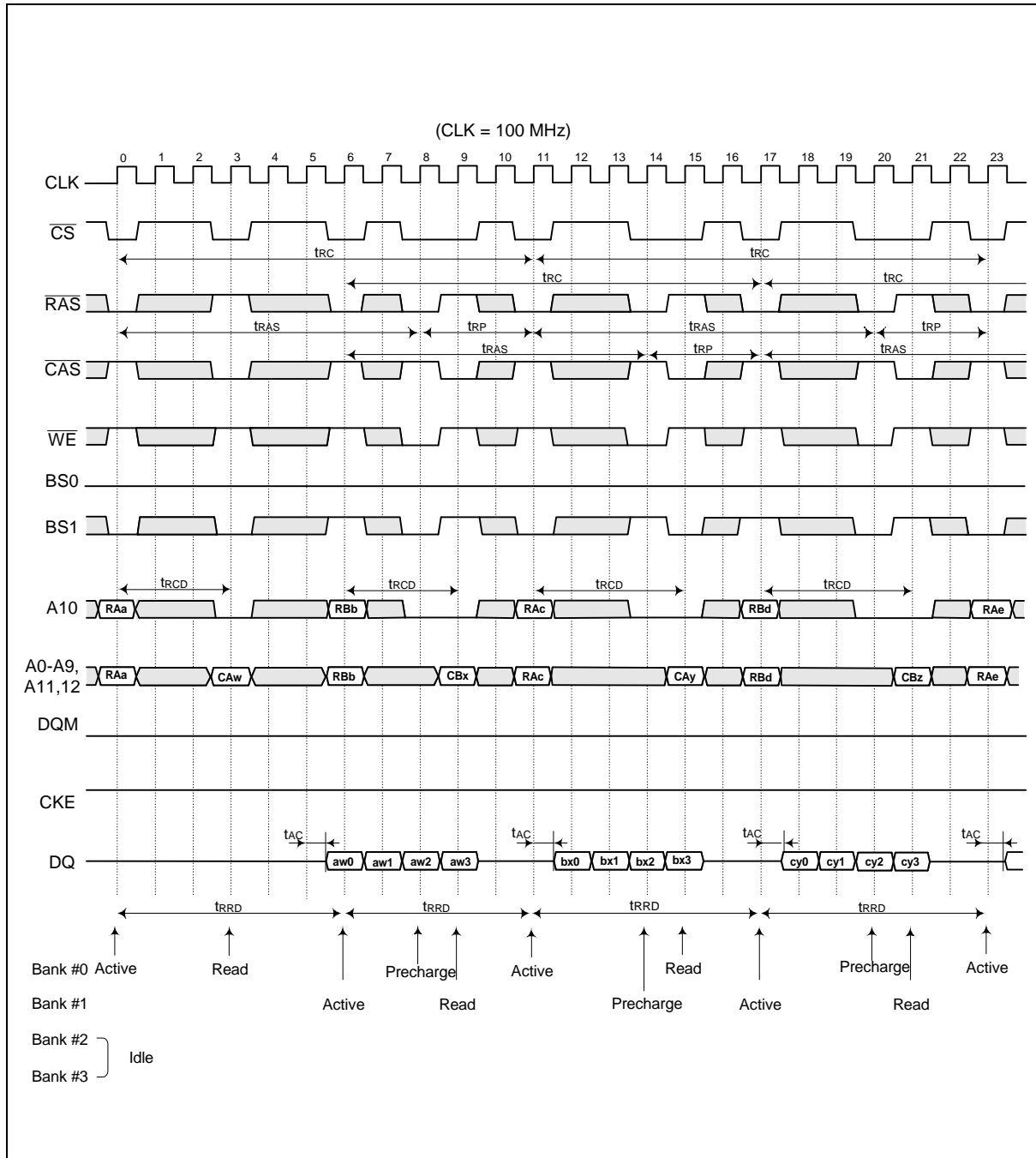



Operating Timing Example, continued

## Interleaved Bank Read (Burst Length = 4, CAS Latency = 3, Auto Precharge)

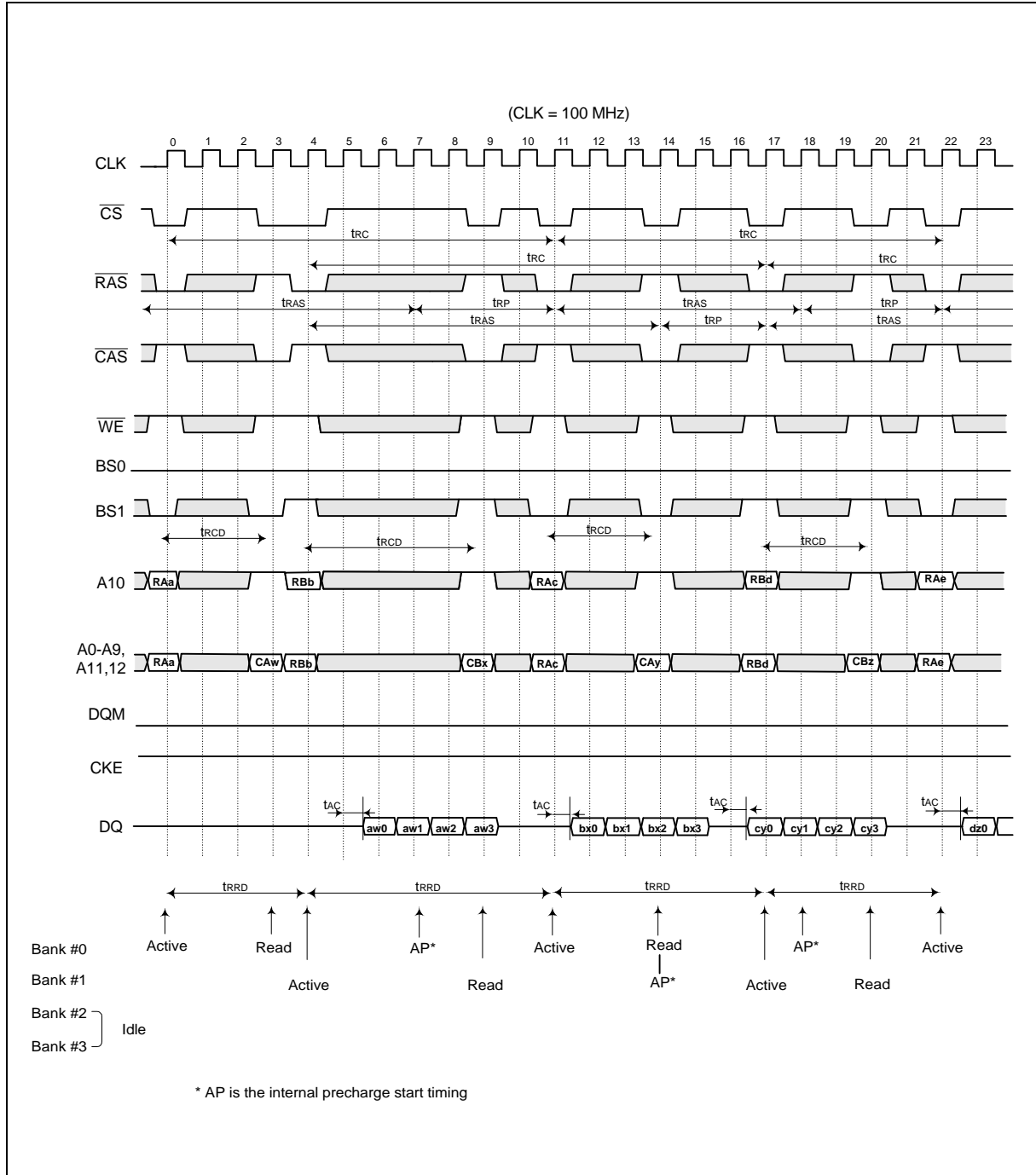



Operating Timing Example, continued

## Interleaved Bank Read (Burst Length = 8, CAS Latency = 3)

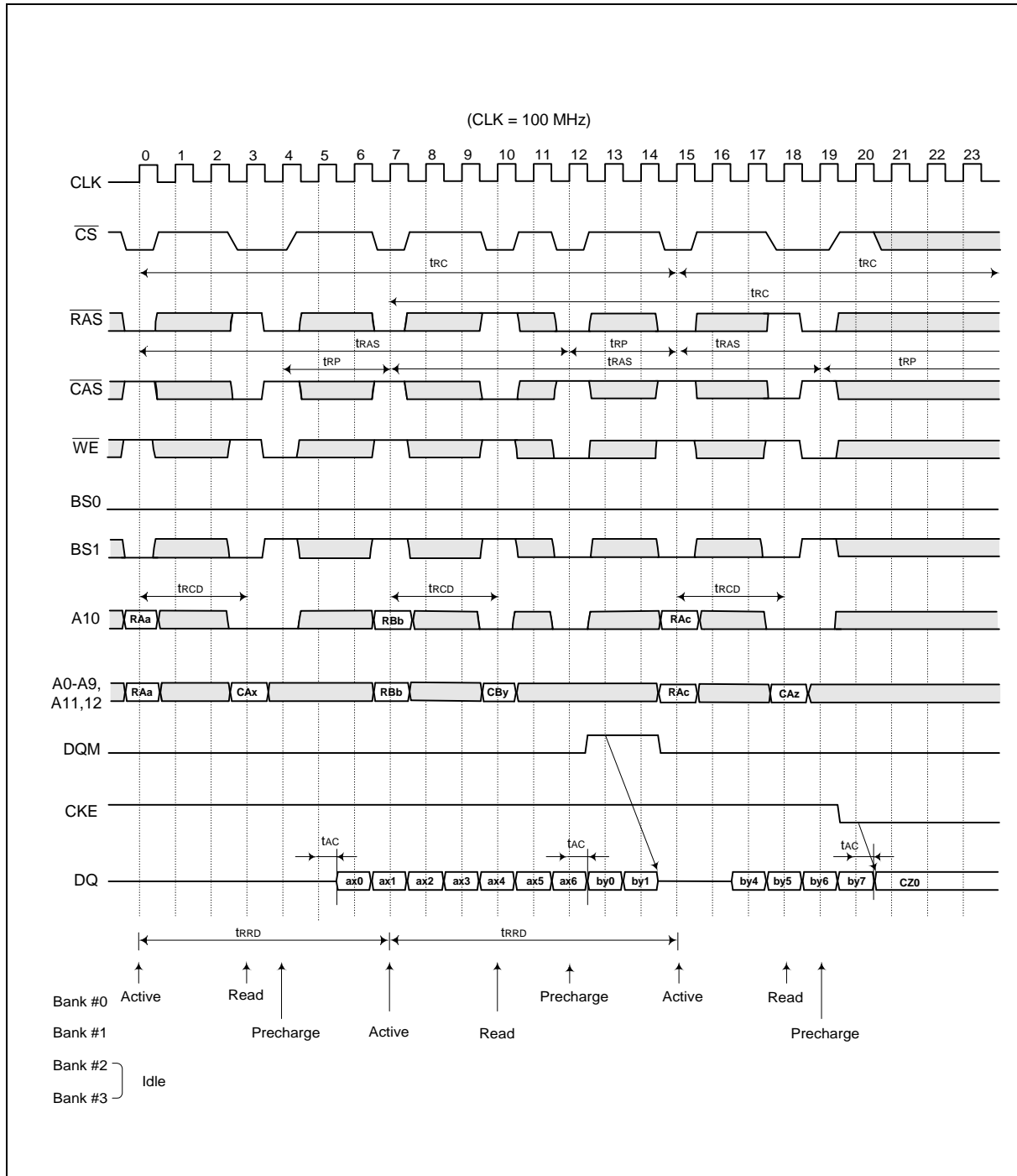



Operating Timing Example, continued

## Interleaved Bank Read (Burst Length = 8, CAS Latency = 3, Auto Precharge)

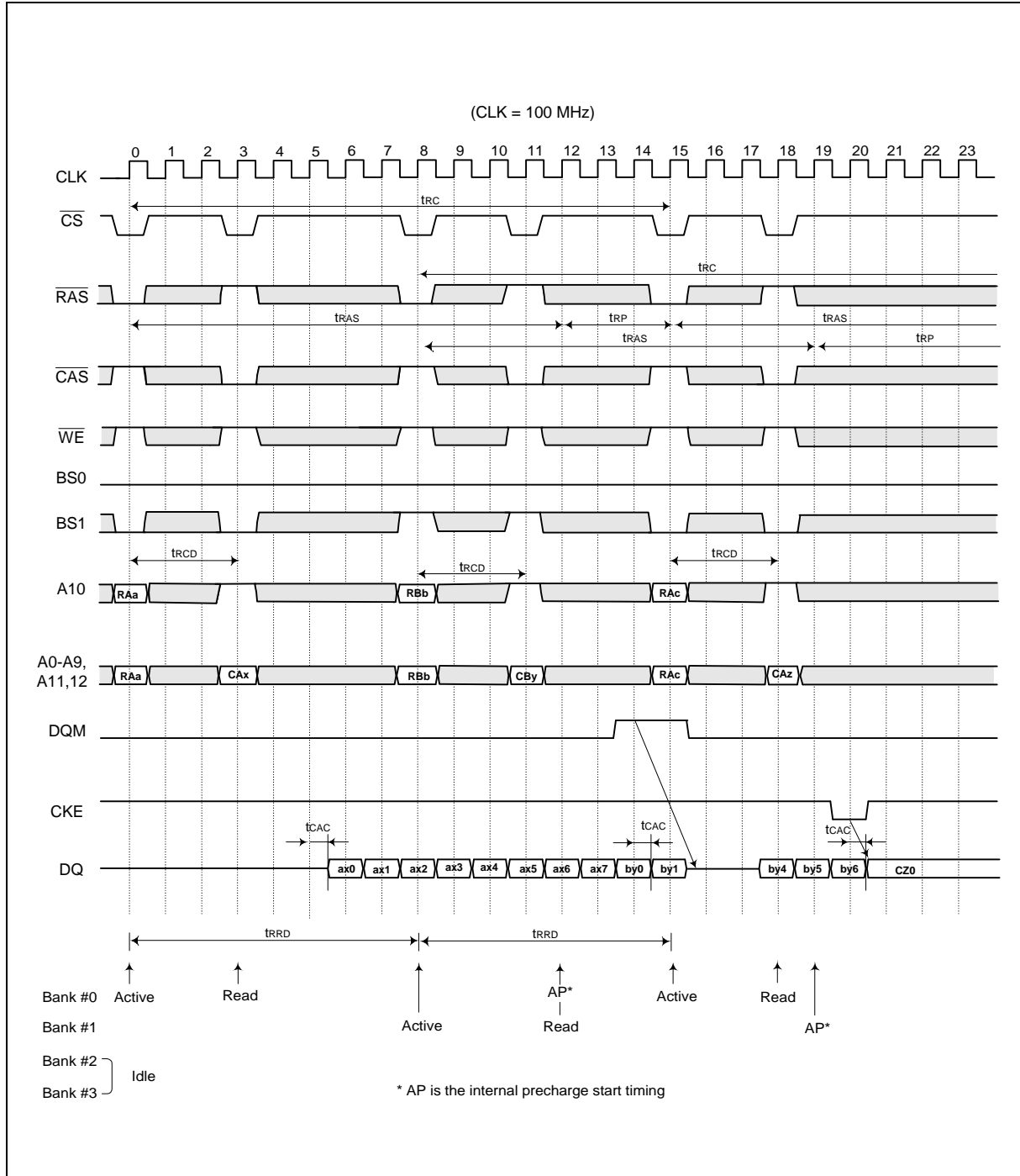





Operating Timing Example, continued

## Interleaved Bank Write (Burst Length = 8)

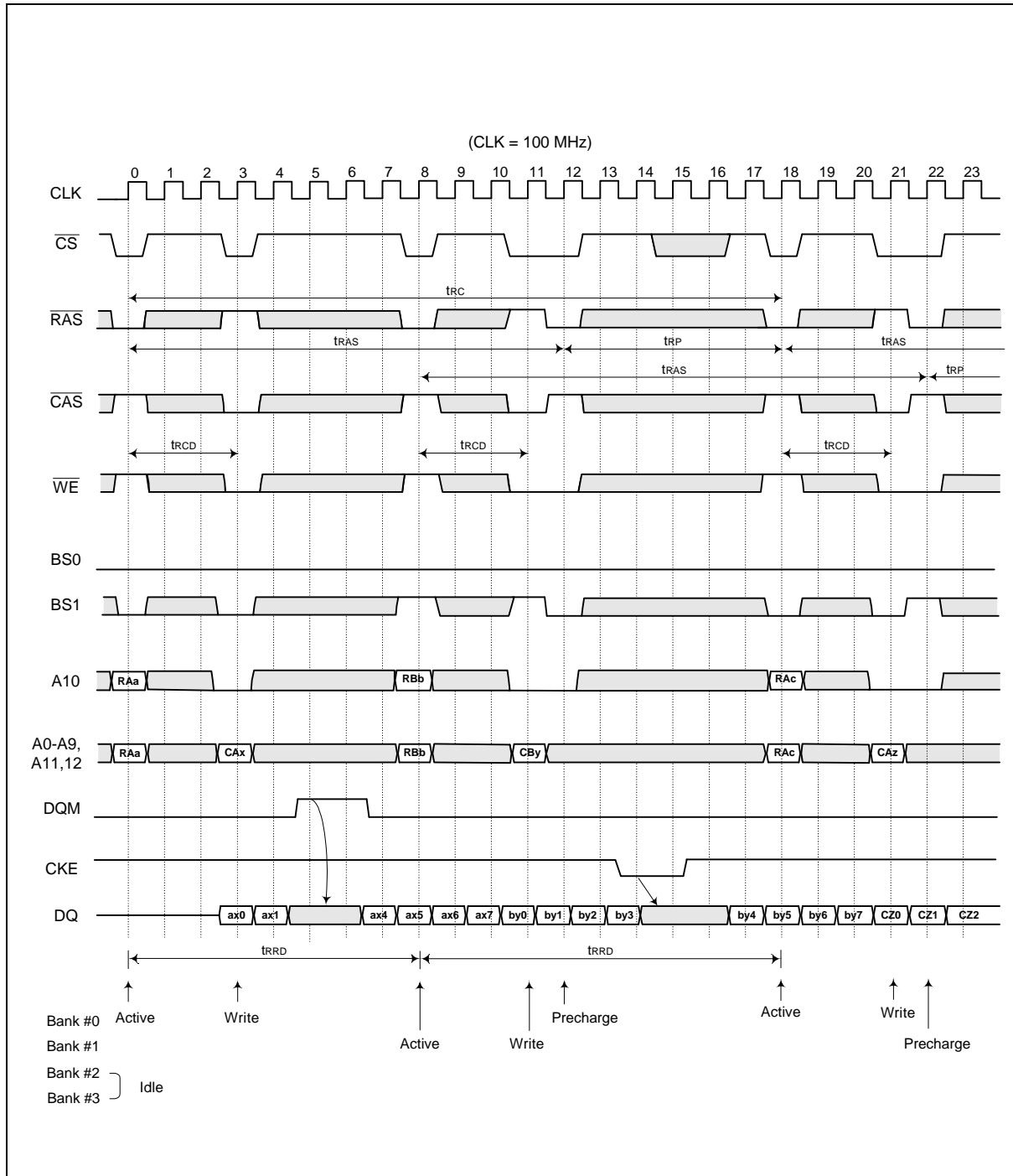



Operating Timing Example, continued

## Interleaved Bank Write (Burst Length = 8, Auto Precharge)

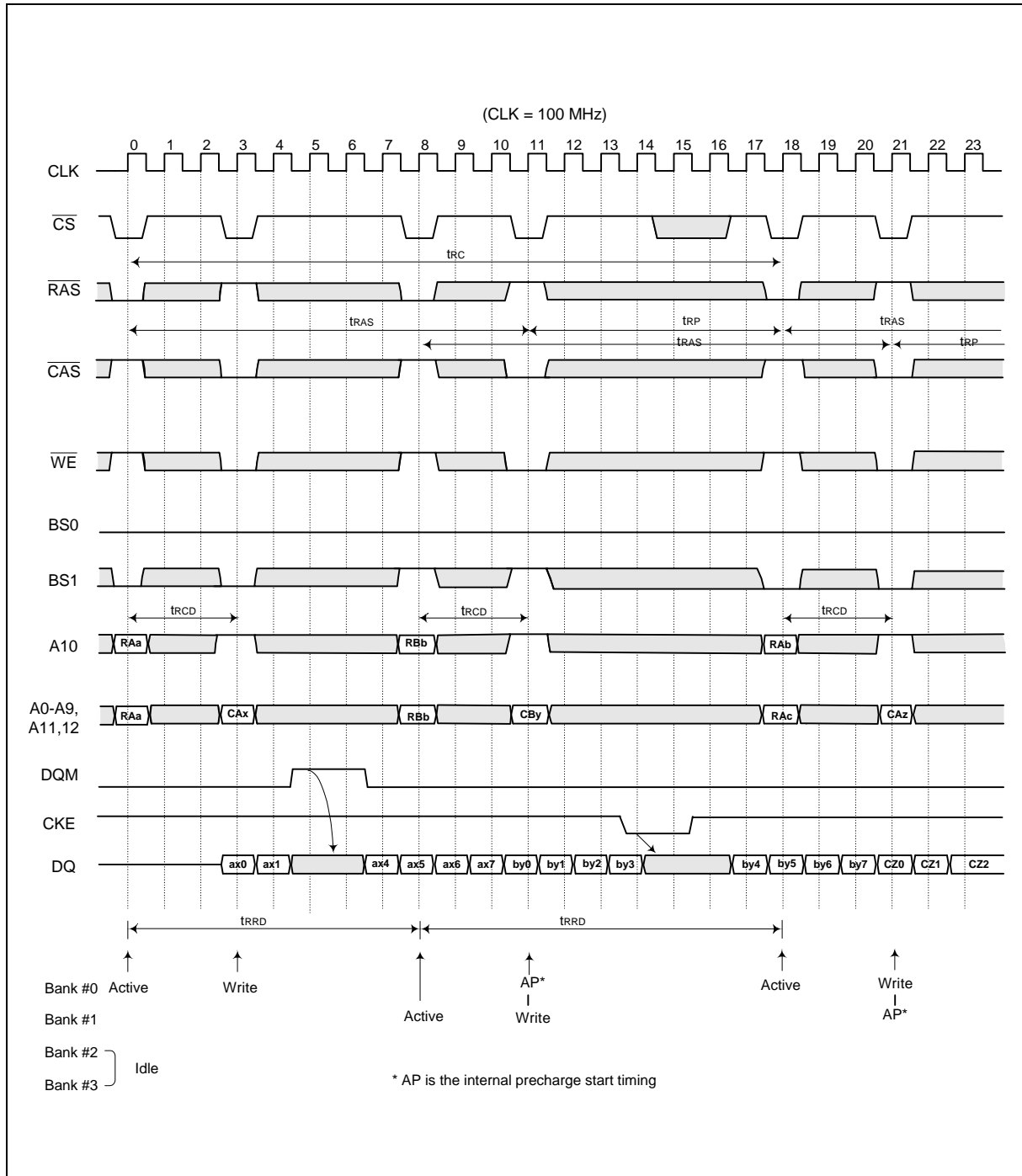



Operating Timing Example, continued

## Page Mode Read (Burst Length = 4, CAS Latency = 3)

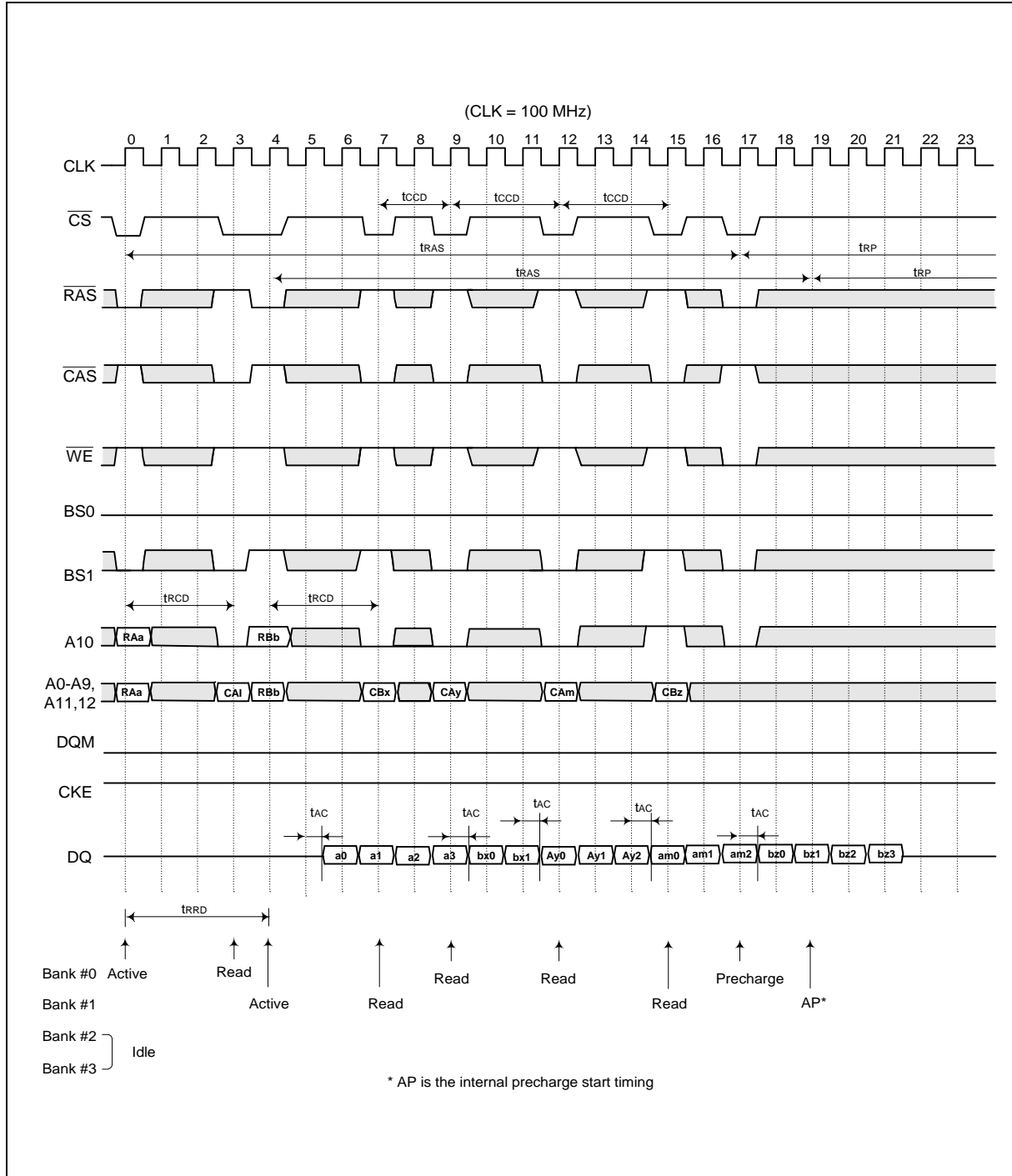



Operating Timing Example, continued

## Page Mode Read/Write (Burst Length = 8, CAS Latency = 3)

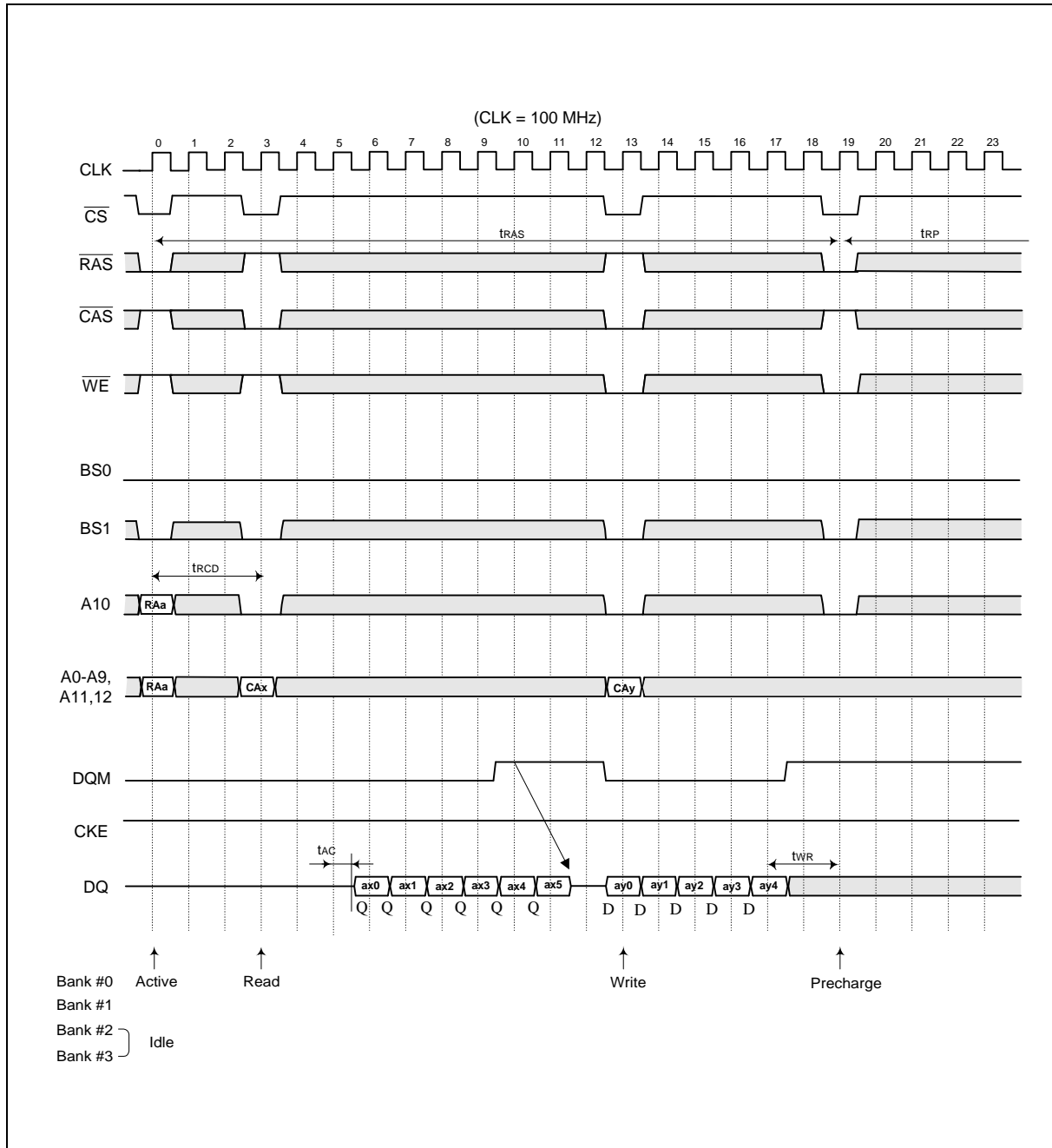



Operating Timing Example, continued

## Auto Precharge Read (Burst Length = 4, CAS Latency = 3)

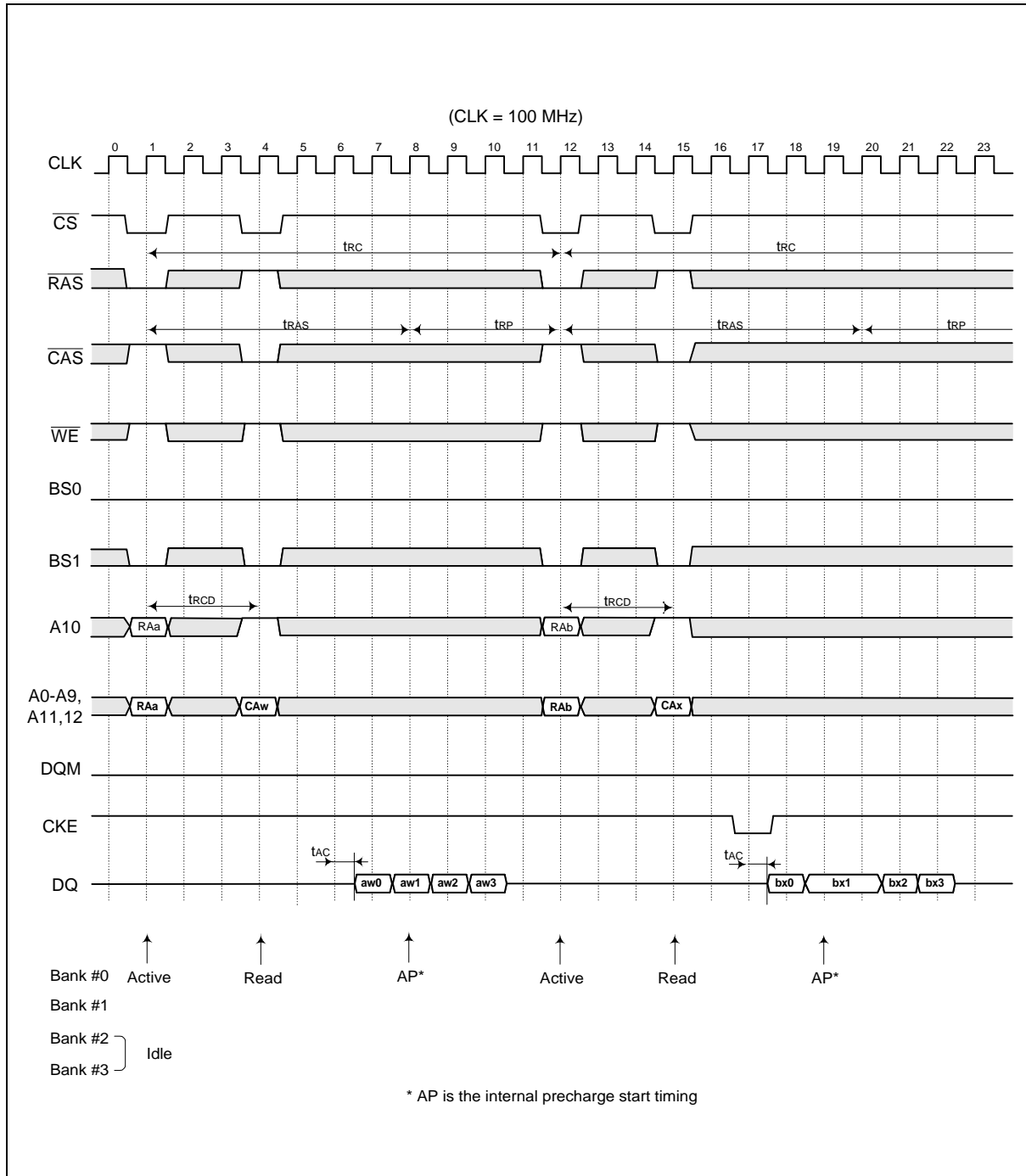



Operating Timing Example, continued

## Auto Precharge Write (Burst Length = 4)

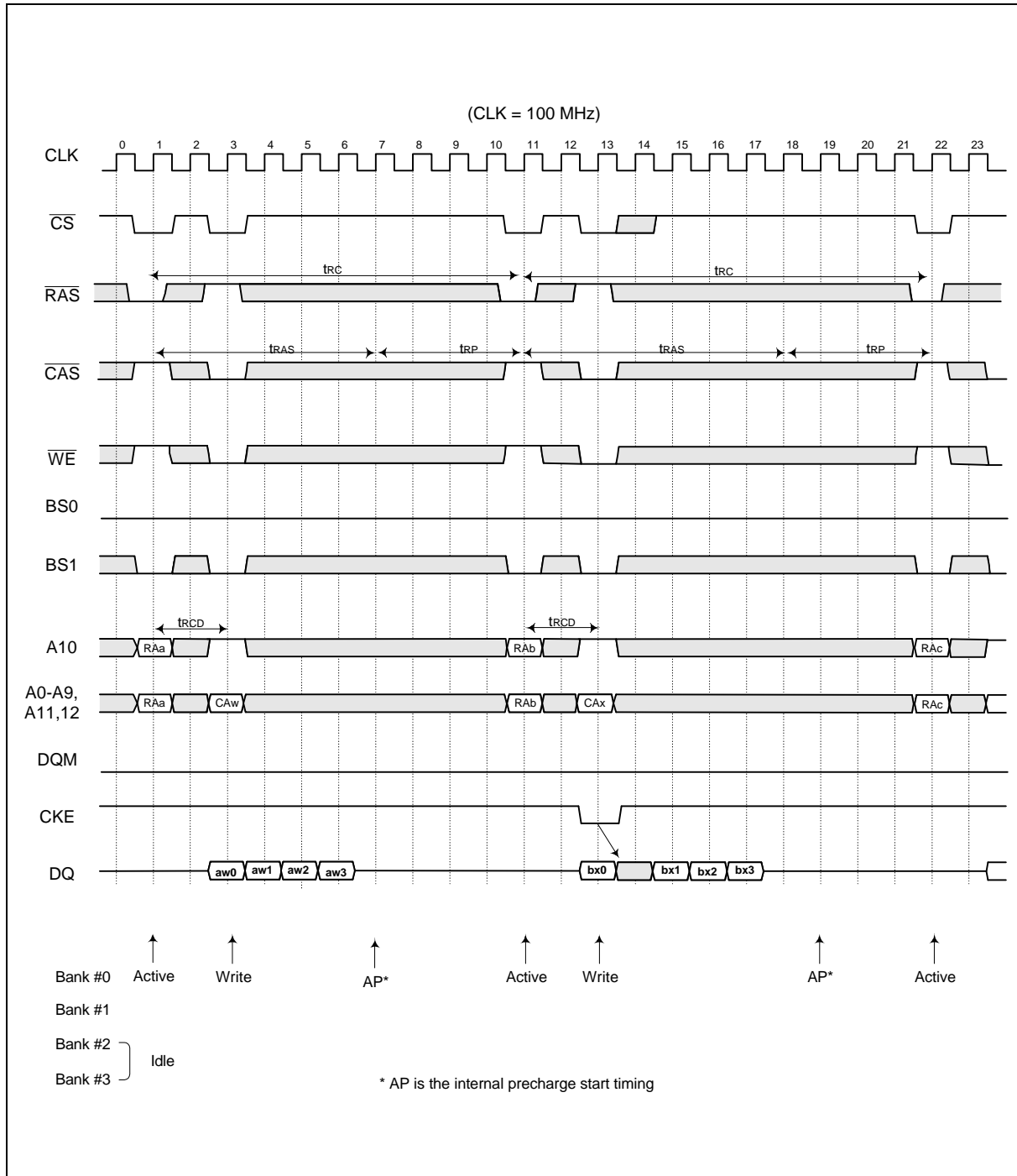



Operating Timing Example, continued

## Auto Refresh Cycle

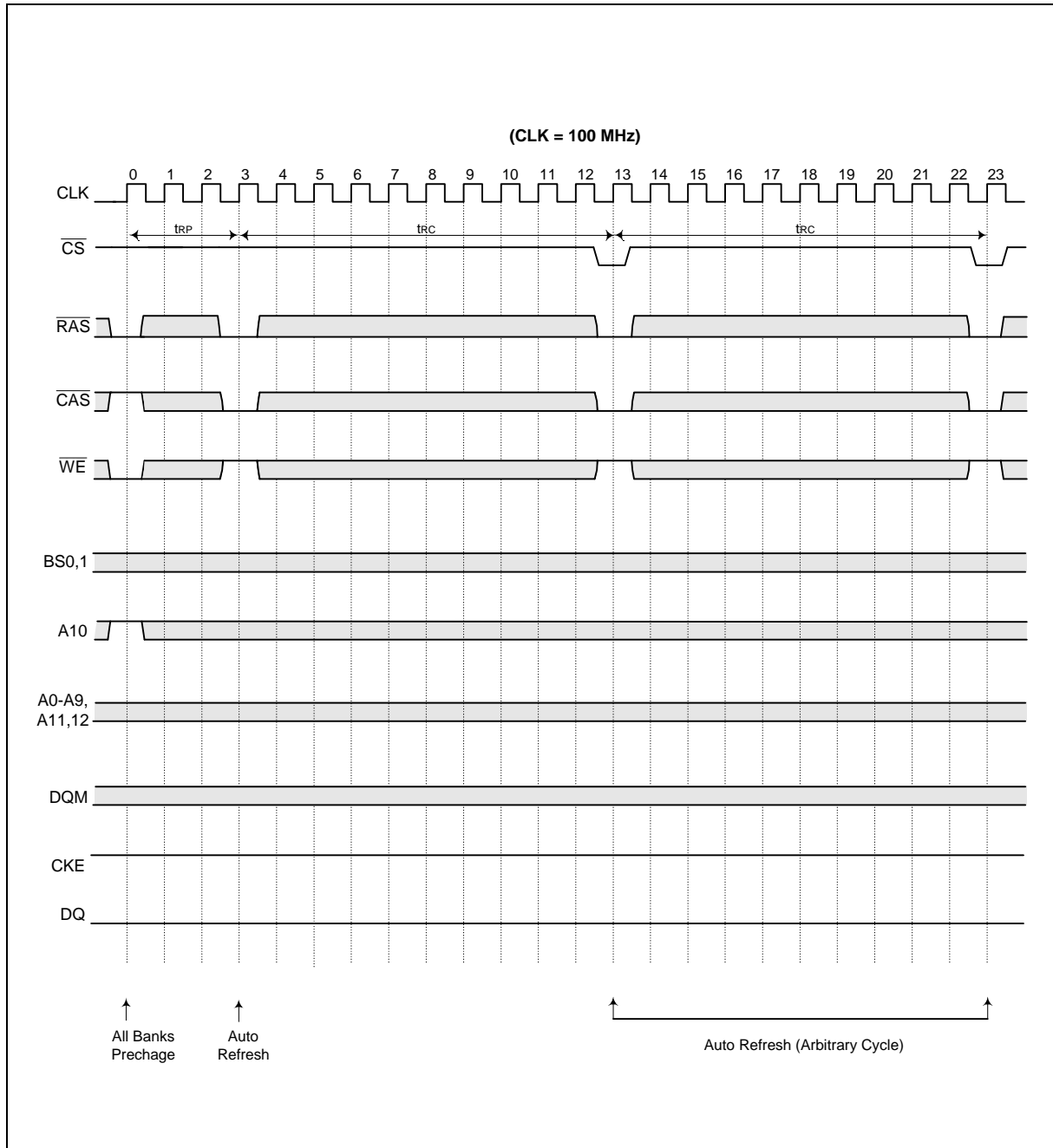

Operating Timing Example, continued

## Self Refresh Cycle

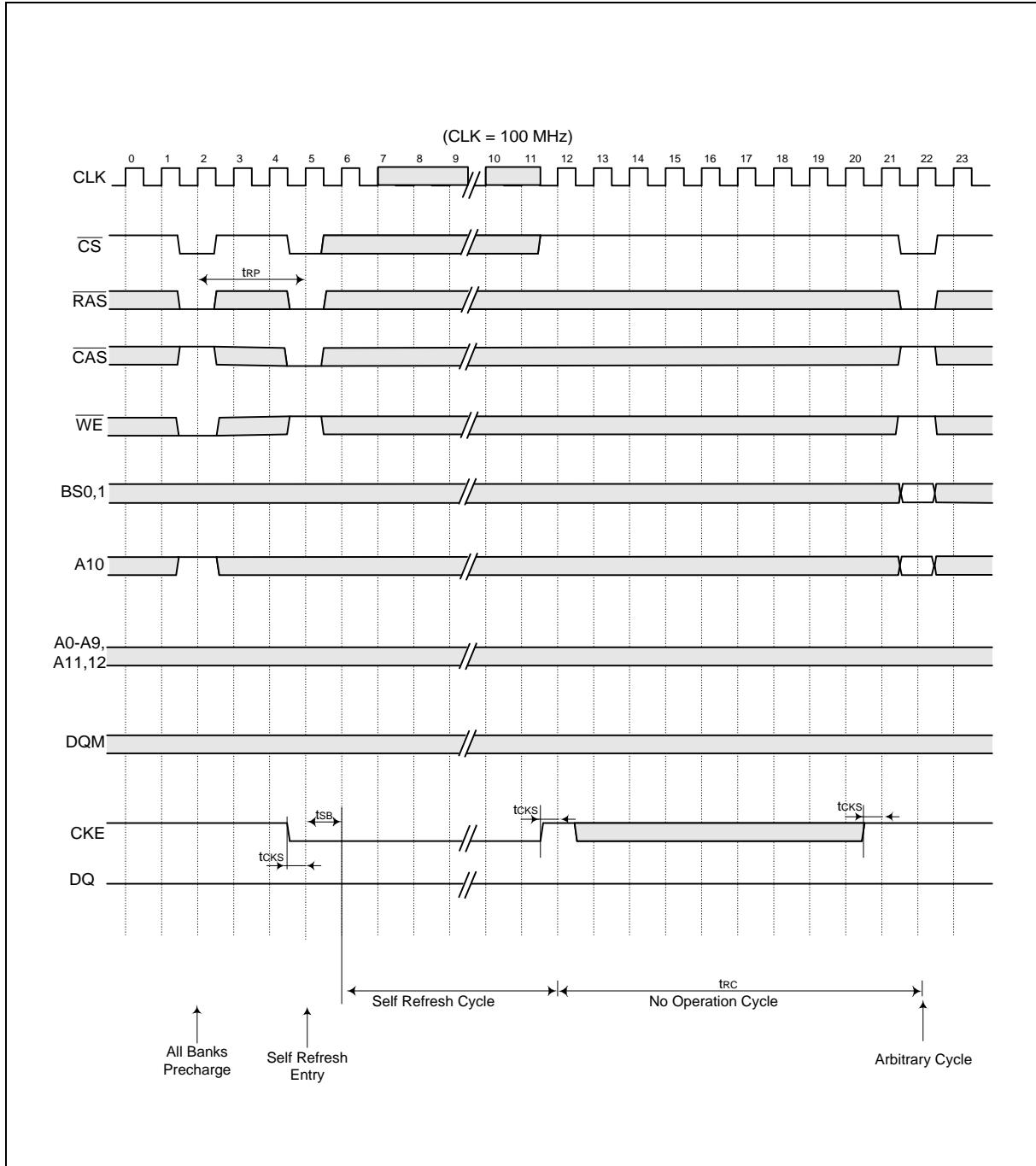





Operating Timing Example, continued

## Burst Read and Single Write (Burst Length = 4, CAS Latency = 3)

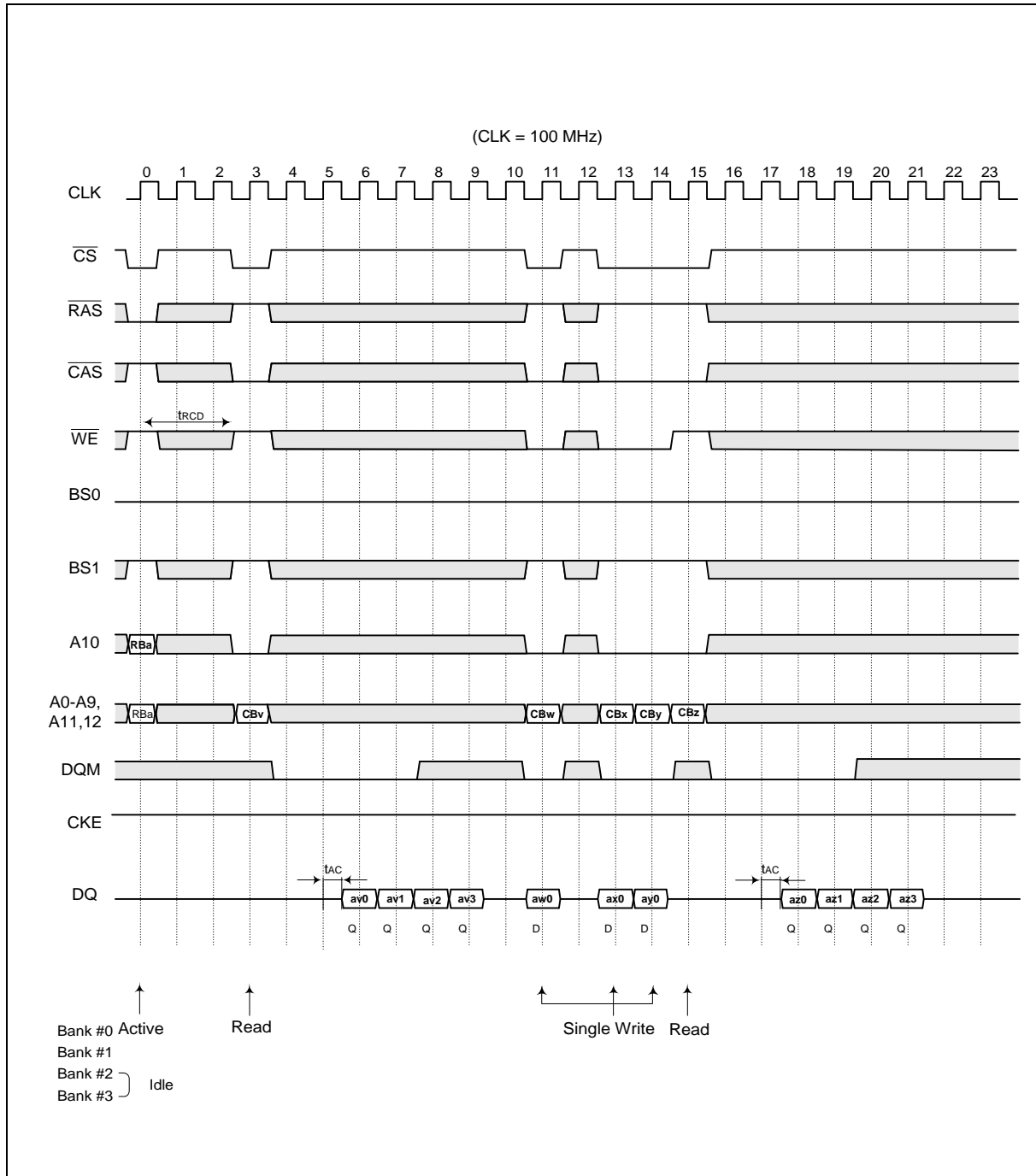



Operating Timing Example, continued

## Power-down Mode

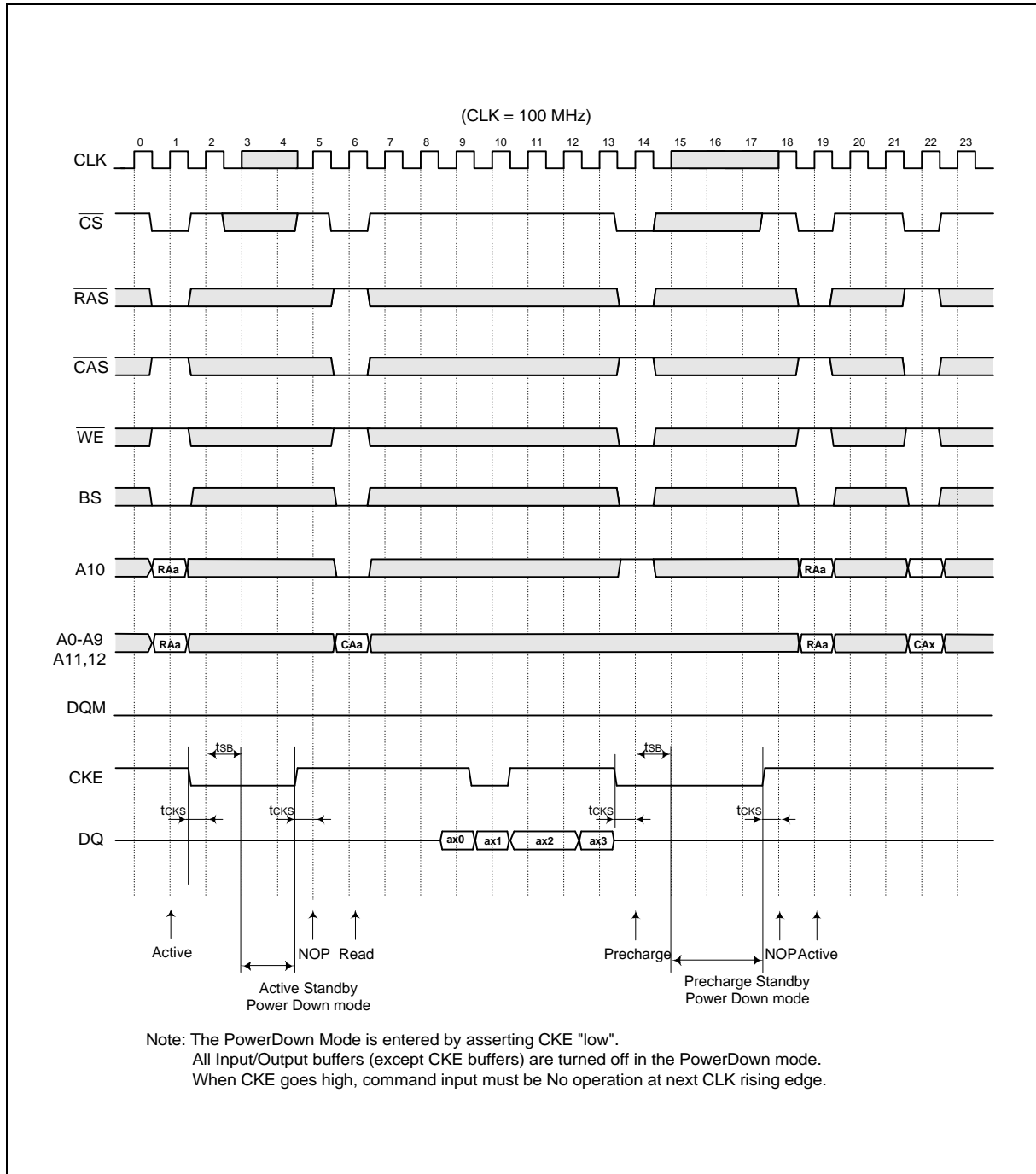



Operating Timing Example, continued

**Auto Precharge Timing (Read Cycle)**

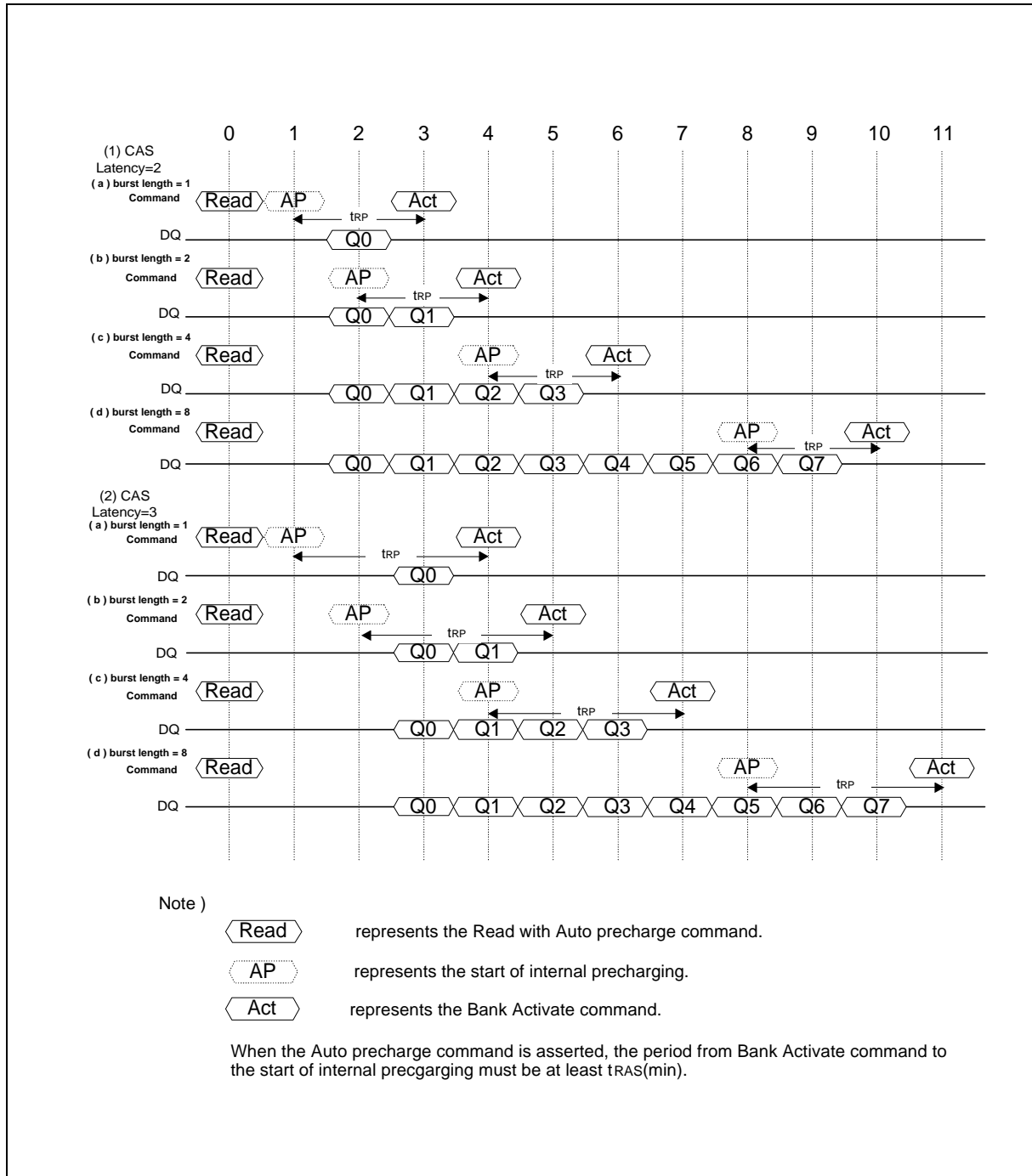



Operating Timing Example, continued

**Auto Precharge Timing (Write Cycle)**

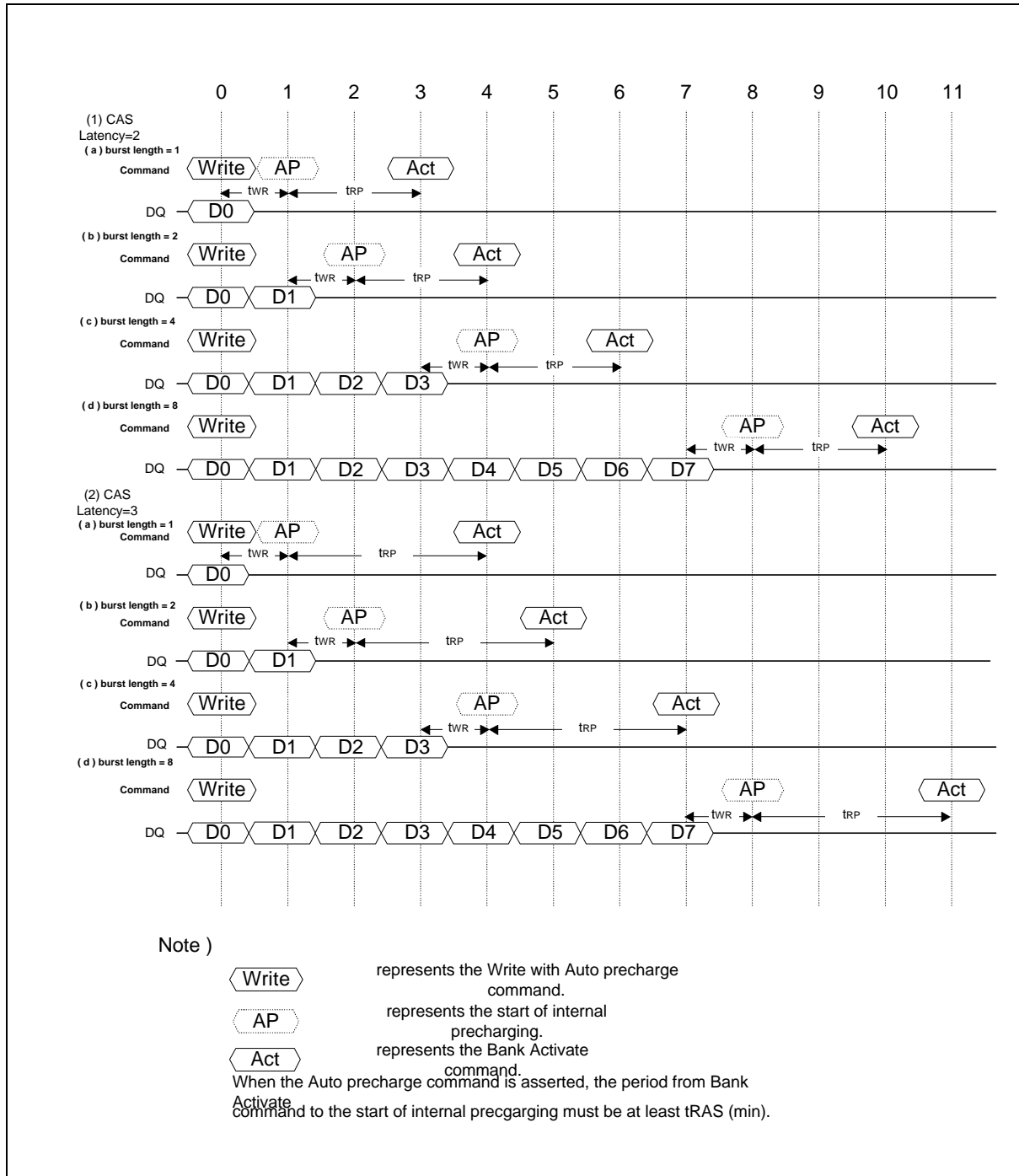

Operating Timing Example, continued

## Timing Chart of Read to Write Cycle

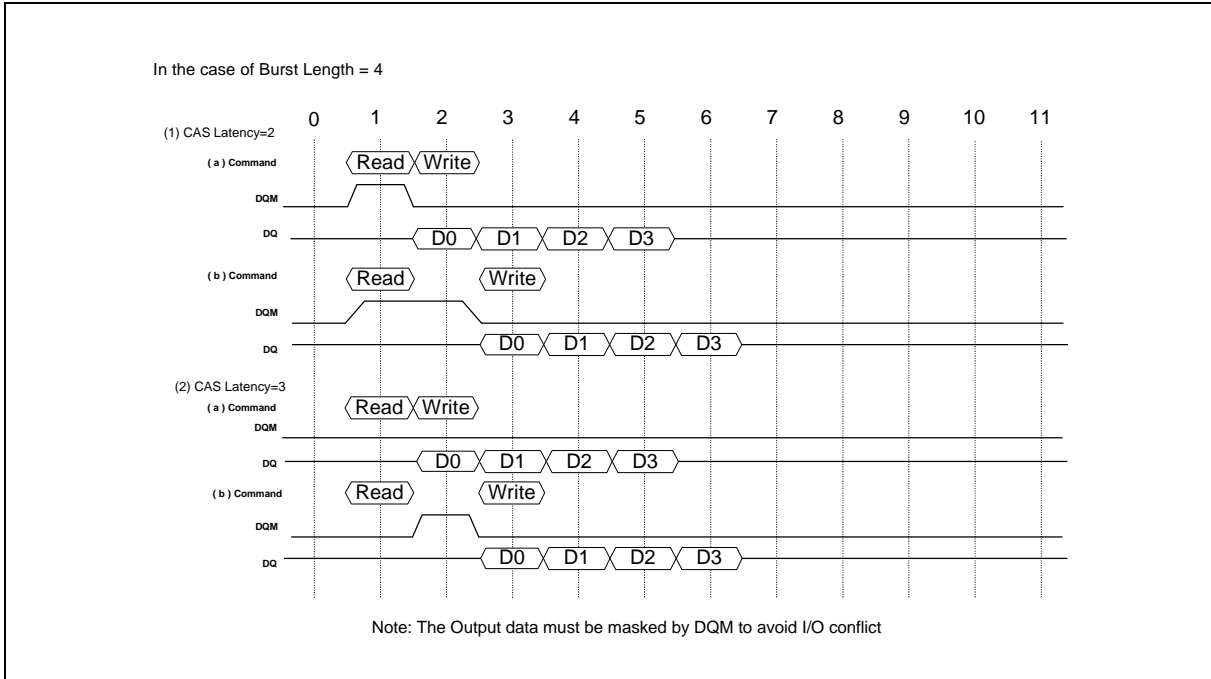

## Timing Chart of Write to Read Cycle

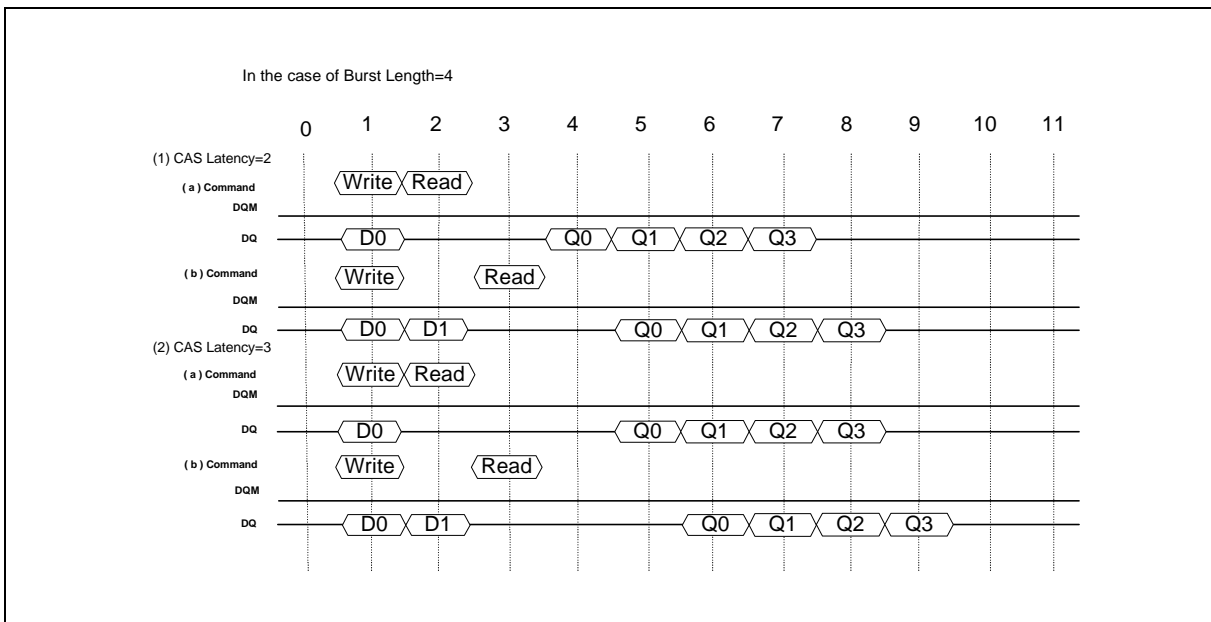



Operating Timing Example, continued

### Timing Chart of Burst Stop Cycle (Burst Stop Command)

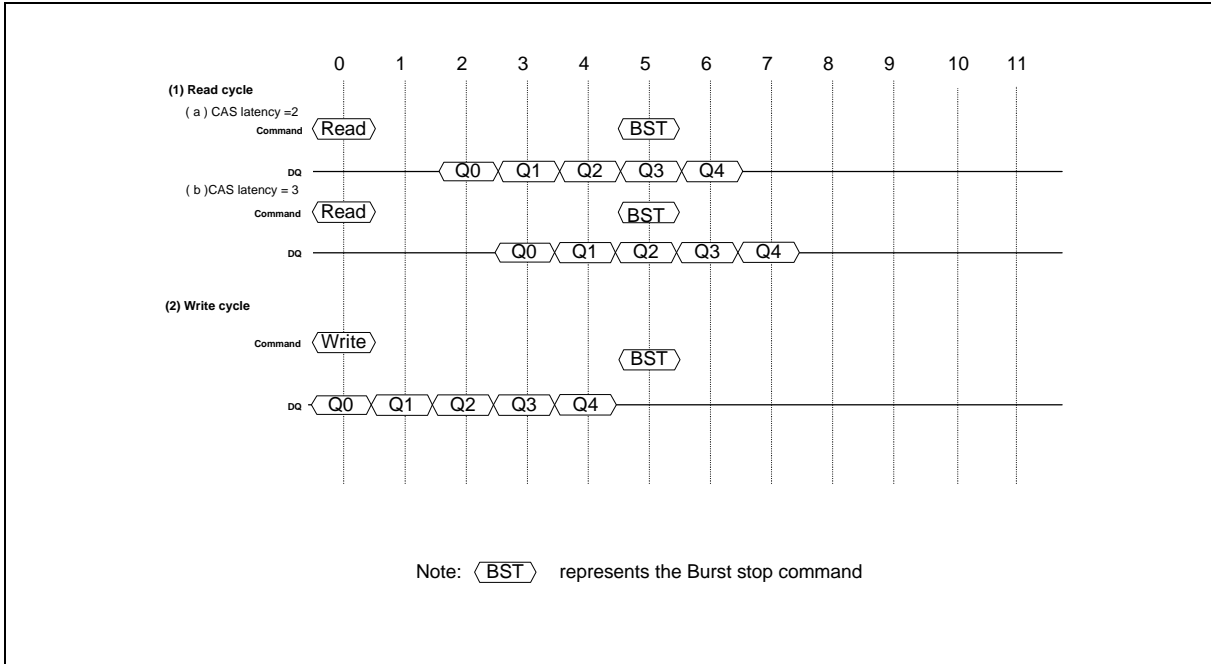

### Timing Chart of Burst Stop Cycle (Precharge Command)

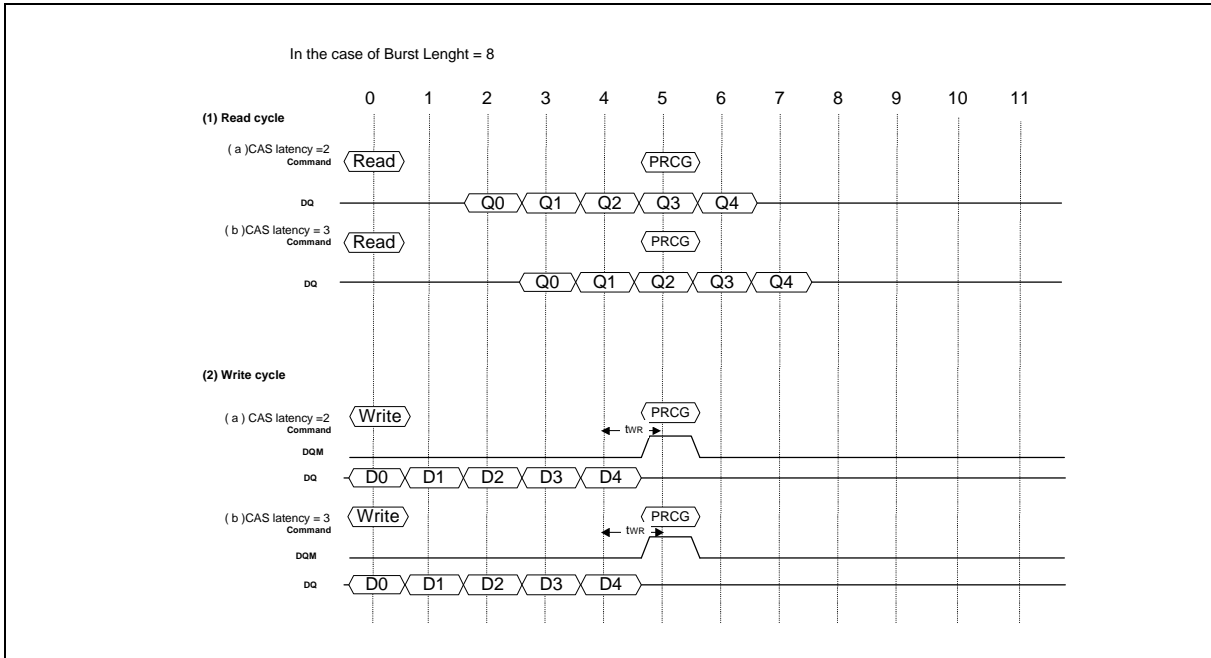



Operating Timing Example, continued

**CKE/DQM Input Timing (Write Cycle)**

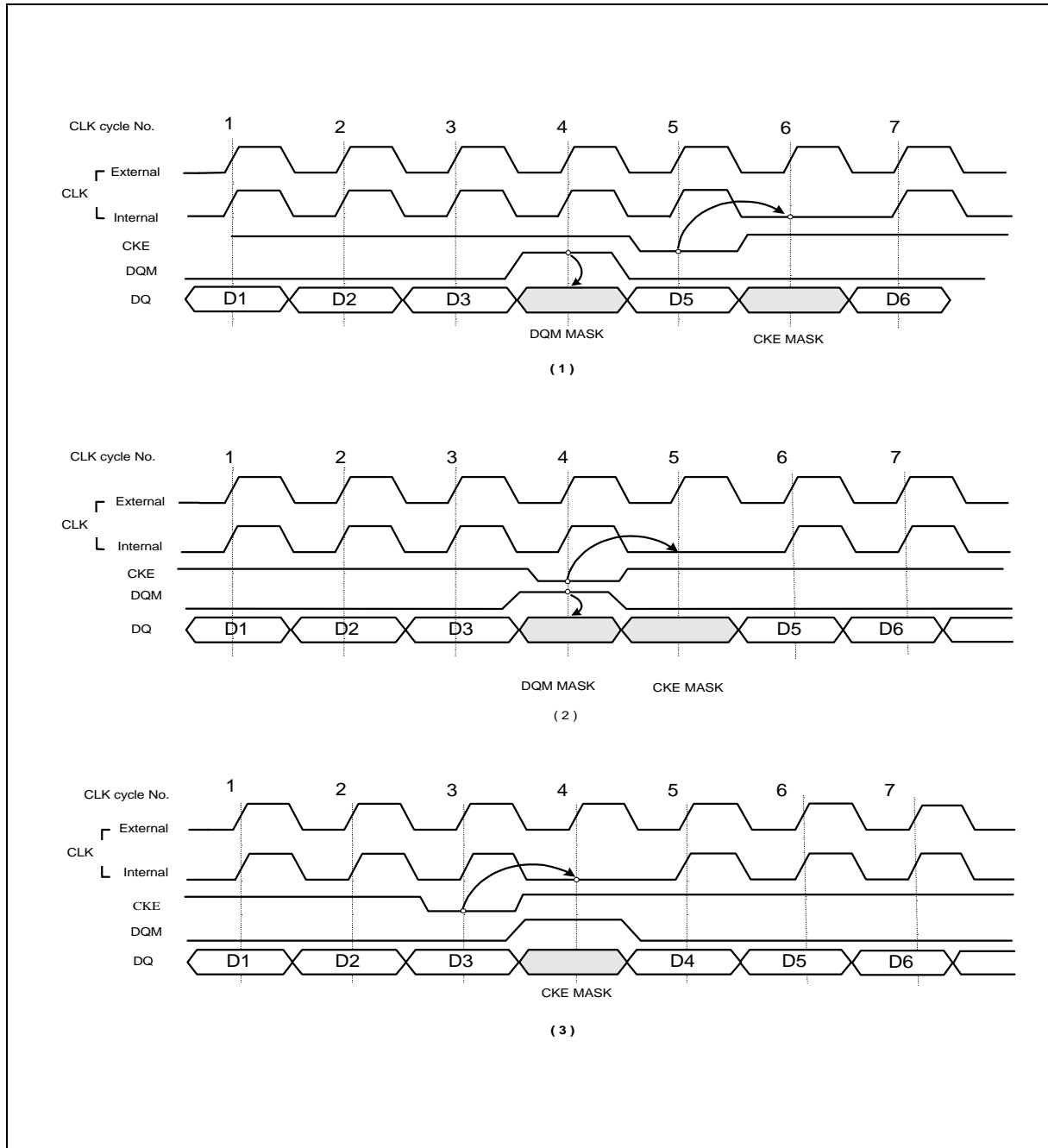

Operating Timing Example, continued

**CKE/DQM Input Timing (Read Cycle)**

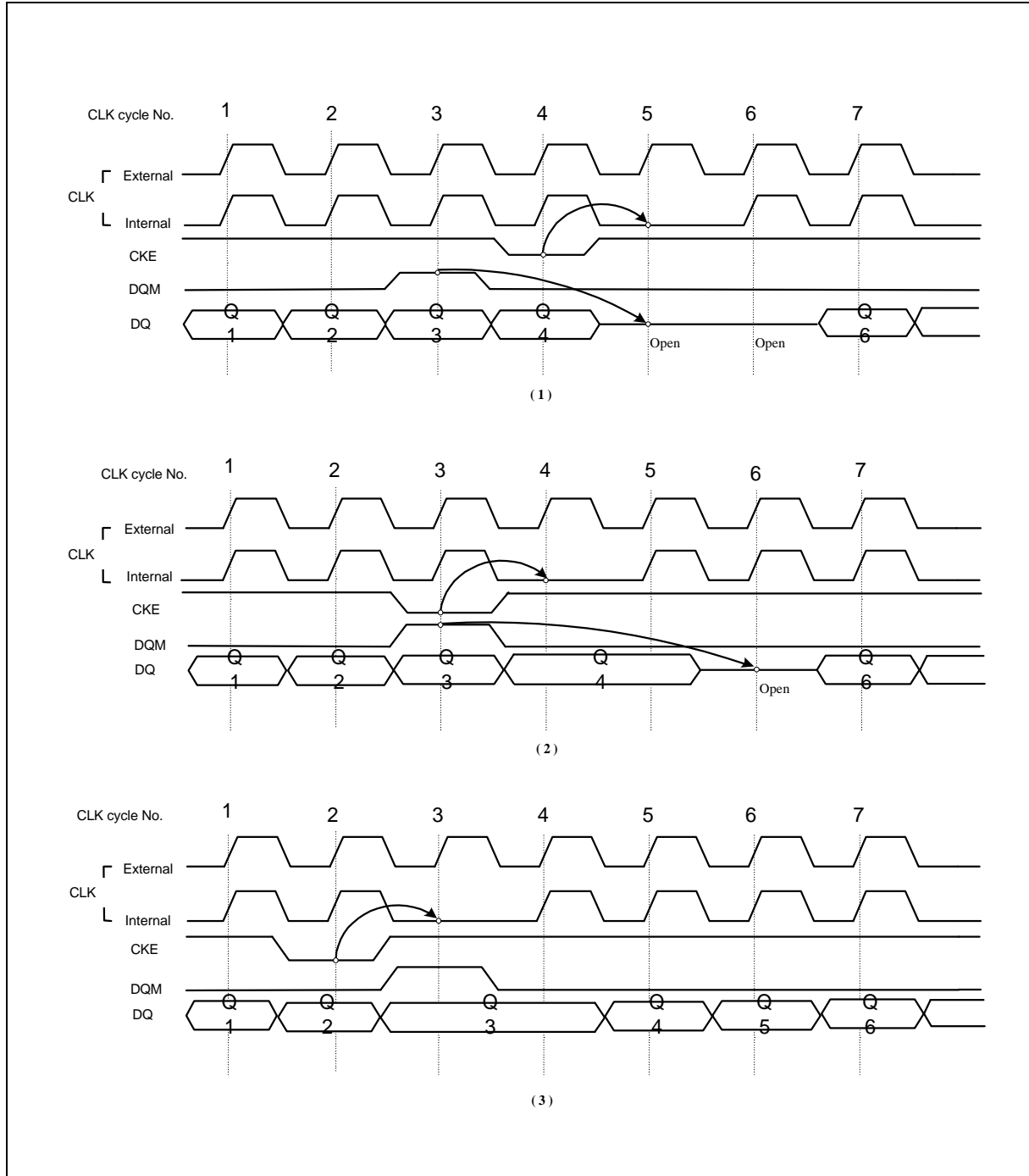



Operating Timing Example, continued

### Self Refresh/Power-down Mode Exit Timing

Asynchronous Control

Input Buffer turn on time ( Power down mode exit time ) is specified by  $t_{CKS}(\min) + t_{CK}(\min)$

A )  $t_{CK} < t_{CKS}(\min) + t_{CK}(\min)$

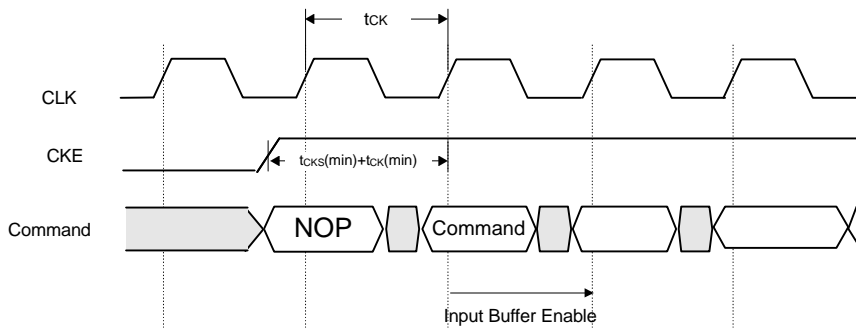

B )  $t_{CK} \geq t_{CKS}(\min) + t_{CK}(\min)$

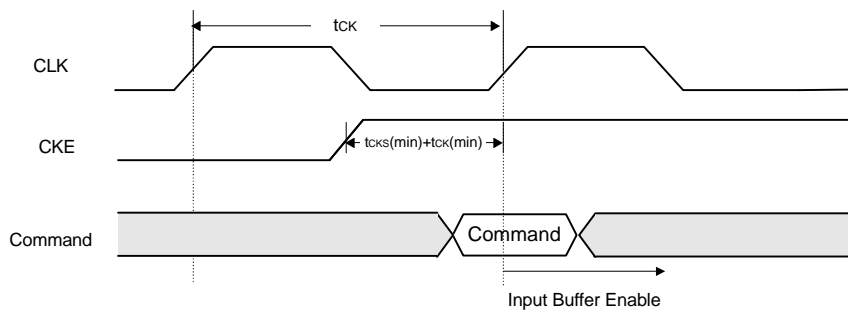

Note )

All Input Buffer(Include CLK Buffer) are turned off in the Power Down mode and Self Refresh mode

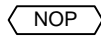
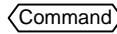
-  Represents the No-Operation command
-  Represents one command

12. PACKAGE DIMENSION

54L TSOP (II)-400 mil

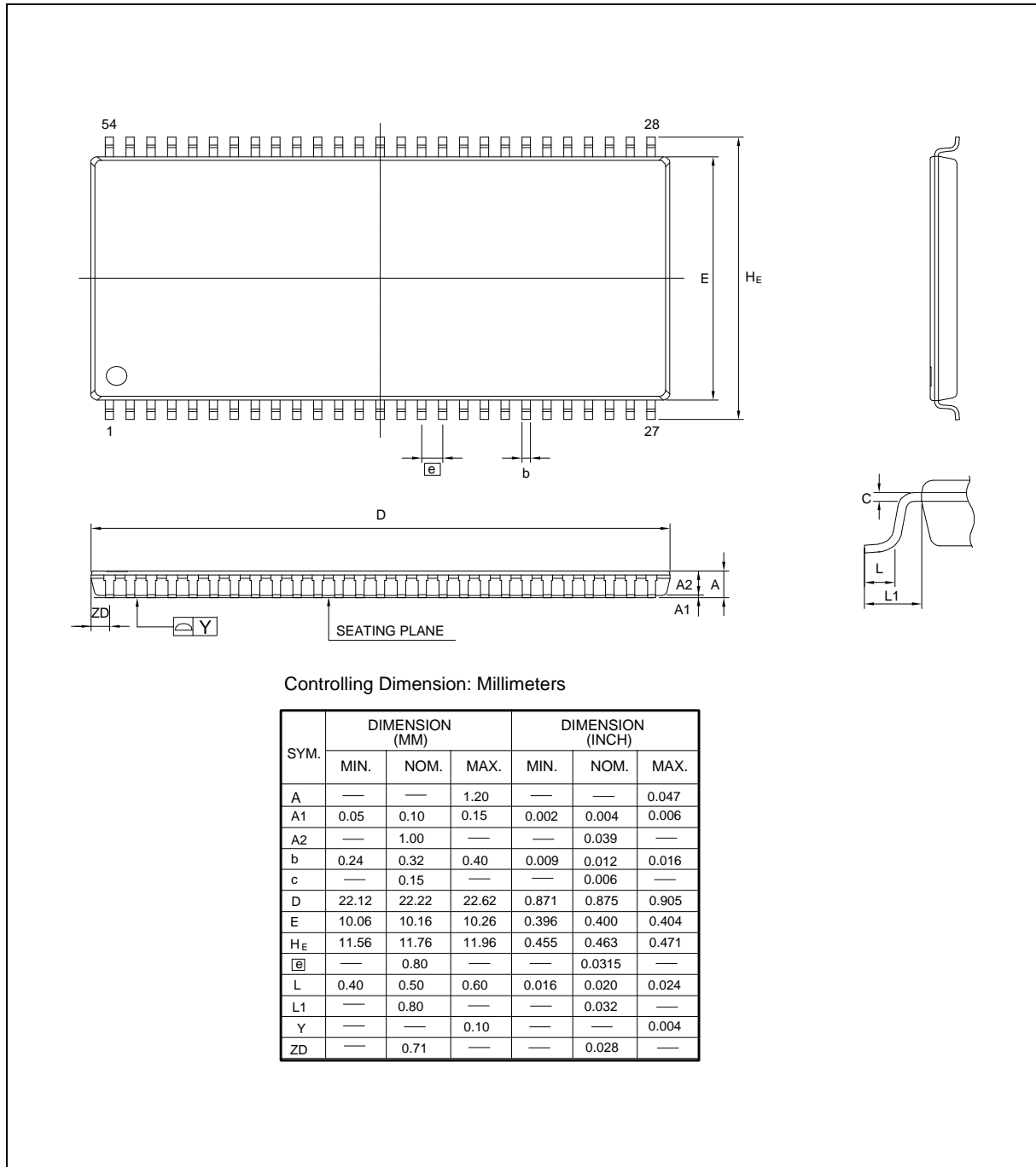

**Headquarters**

No. 4, Creation Rd. III,  
Science-Based Industrial Park,  
Hsinchu, Taiwan  
TEL: 886-3-5770066  
FAX: 886-3-5665577  
<http://www.winbond.com.tw/>

**Taipei Office**

11F, No. 115, Sec. 3,  
Min-Sheng East. Rd.,  
Taipei, Taiwan  
TEL: 886-2-27190505  
FAX: 886-2-27197502

**Winbond Electronics Corporation America**

2727 North First Street, San Jose,  
CA 95134, U.S.A.  
TEL: 1-408-9436666  
FAX: 1-408-5441798

**Winbond Electronics Corporation Japan**

7F Daini-ueno BLDG, 3-7-18  
Shinyokohama Kohoku-ku,  
Yokohama, 222-0033  
TEL: 81-45-4781881  
FAX: 81-45-4781800

**Winbond Electronics (Shanghai) Ltd.**

27F, 2299 Yan An W. Rd. Shanghai,  
200336 China  
TEL: 86-21-62365999  
FAX: 86-21-62365998

**Winbond Electronics (H.K.) Ltd.**

Unit 9-15, 22F, Millennium City,  
No. 378 Kwun Tong Rd.,  
Kowloon, Hong Kong  
TEL: 852-27513100  
FAX: 852-27552064

*Please note that all data and specifications are subject to change without notice.  
All the trade marks of products and companies mentioned in this data sheet belong to their respective owners.*