

**Accessories Industrial Power Relay RT**

- For Industrial Power Relay RT  
pinnings 3.5mm / 5mm; relay height 15.7 mm
- New retainer clip with ejection function
- Easy replacement of relays on a densely packed DIN rail
- No reduction of protection class or creepage/clearance with plastic retainer
- Simple plug-in indicator- and protection modules
- White snap-on marking tags
- RoHS compliant (Directive 2002/95/EC)

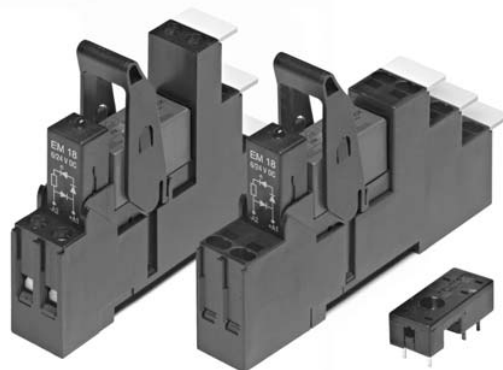

F0228-G

**Premium socket with screwless terminals for DIN rail mounting**

RT 78 72P Premium socket, logical terminal arrangement

- Screwless Clamps
- Mounting of solid wires without tool
- Double Clamps per terminal
- Jumper links for interconnection
- Open coil circuit for active modules
- Logical terminal arrangement

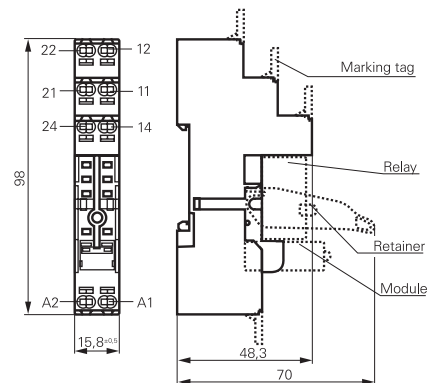

S0545-CA

**Approvals**

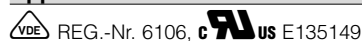

\*) For 1 pole relays (16 A) the relay terminals 11-21, 12-22 and 14-24 have to be bridged.

**Technical data**

Rated voltage / max. switching voltage AC	240 / 400 VAC
Rated current	2 x 8 A, 16 A*)
Dielectric strength coil-contact circuit	5000 V <sub>rms</sub>
open contact circuit	1000 V <sub>rms</sub>
adjacent contact circuits	2500 V <sub>rms</sub>
Clearance / creepage coil-contact circuit	≥ 10 / 10 mm
Material group of insulation parts	IIIa
Insulation to IEC 60664-1	
Type of insulation coil-contact circuit	reinforced
open contact circuit	functional
adjacent contact circuits	functional
Rated insulation voltage	250 V
Pollution degree	2
Rated voltage system	230 / 400 V
Overvoltage category	III
RoHS - Directive 2002/95/EC	compliant

- Not suitable for bistable relays with 2 coils!

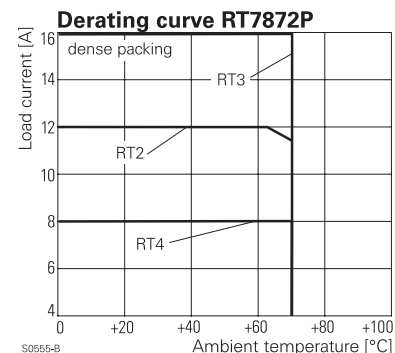

S0555-B

**Accessories Industrial Power Relay RT (Continued)**

**Technical data (Continued)**

Ambient temperature range	
for mounting/handling	-20...+70°C
in operation	-40...+70°C
Terminals	screwless
Wire strip length	12 mm
Wire cross section	
solid wire	1 x 0.75/1/1.5 mm <sup>2</sup> 2 x 0.75/1 mm <sup>2</sup>
with standard isolation (no oversize isolation)	2 x 1.5 mm <sup>2</sup>
stranded wire	
without bootlace crimp	1 x 0.75/1/1.5 mm <sup>2</sup> 2 x 0.75/1 mm <sup>2</sup>
without bootlace crimp with standard isolation	2 x 1.5 mm <sup>2</sup>
with bootlace crimp	1 x 0.75/1 mm <sup>2</sup> 2 x 0.75 mm <sup>2</sup>
with bootlace crimp without isolation	1 x 1.5 mm <sup>2</sup>
or isolation min 18 mm long	

For stranded wires with braids 0.05 mm or smaller the use of bootlace crimps is recommended. When using stranded wires without bootlace crimp the clamp must be opened during insertion.

Insertion cycles	A (10)
Max. Insertion Force total	100 N
Mounting distance	≥ 0, dense packing
Weight	36 g
Packaging unit	10 pcs

**Socket with screwless terminals for DIN rail mounting**

Type	Part Number
<b>RT 78 72P</b> Premium socket, logical terminal arrangement Socket with screwless terminals, pinning 5 mm for DIN rail mounting	1860200-1

**Accessories for RT 78 72P**

Type	Part Number
<b>RT 17 017</b> Plastic retaining clip, relay height 15.7	2022103-1
<b>RT 17 040</b> Marking tag	2-1415038-1
<b>RT 17 0P1</b> Jumper link, max load 12 A	1860211-1

**How to use, Precautions**

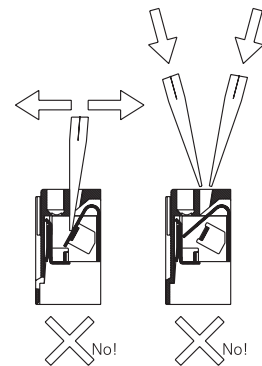
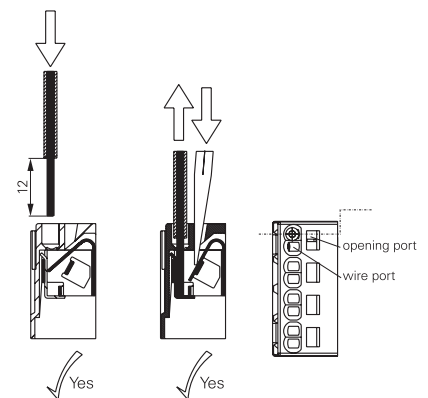
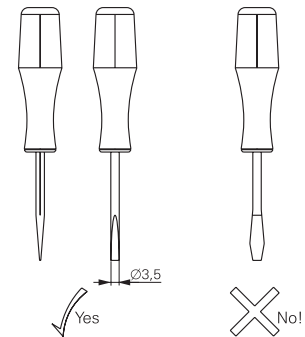

**Jumper link**

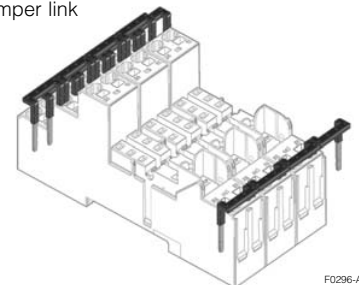

**Accessories Industrial Power Relay RT (Continued)**

**Socket with screw-type terminals for DIN rail mounting**

**RT 78 724** Socket with screw-type terminals, pinning 3.5 mm for DIN rail mounting

**RT 78 726** Socket with screw-type terminals, pinning 5 mm for DIN rail mounting, logical terminal arrangement

- Din-rail socket with logical setup of connections (input/output)
- High quality rising clamp terminals
- Captive combination terminal screws
- Jumper bars for interconnection



F0261-C

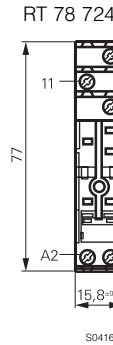

S0416-CA

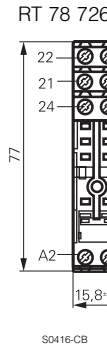

S0416-CB

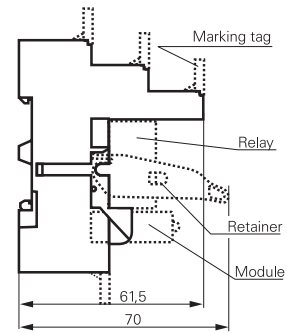

**RT 78 725** Socket with screw-type terminals, pinning 5 mm for DIN rail mounting, conventional terminal arrangement

- Conventional terminal arrangement



F0284-B

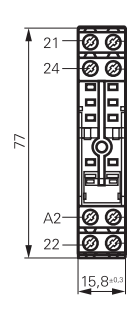

S0540-BT

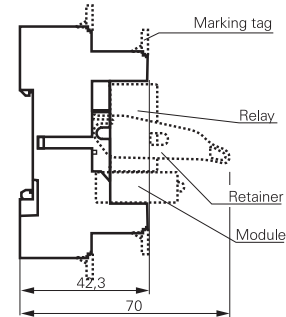

**Approvals**

VDE REG.-Nr. 6106 in preparation, **UL** US E135149

**Technical data**

	<b>RT 78 724 / RT 78 726</b>	<b>RT 78 725</b>
Rated voltage / max. switching voltage AC	240 / 400 VAC	
Rated current	12 A, 2 x 8 A, 16 A*)	
Dielectric strength coil-contact circuit	5000 V <sub>rms</sub>	4000 V <sub>rms</sub>
open contact circuit	1000 V <sub>rms</sub>	1000 V <sub>rms</sub>
adjacent contact circuits	2500 V <sub>rms</sub>	2500 V <sub>rms</sub>
Clearance / creepage coil-contact circuit	≥ 10 / 10 mm	≥ 4.7 / 4.7 mm
Material group of insulation parts	IIIa	
Insulation to IEC 60664-1		
Type of insulation coil-contact circuit	reinforced	basic
open contact circuit		functional
adjacent contact circuits		functional
Rated insulation voltage	250 V	
Pollution degree	2	
Rated voltage system	230 / 400 V	
Overvoltage category	III	
RoHS - Directive 2002/95/EC	compliant	
Ambient temperature range for mounting/handling in operation	-20...+70°C -40...+70°C	

\*) For 1 pole relays (16 A) the relay terminals 11-21, 12-22 and 14-24 have to be bridged.  
For 1 pole relays (12 A) the relay terminals 11-12-14 have to be connected to the socket terminals 21-12-24

- Not suitable for bistable relays with 2 coils!

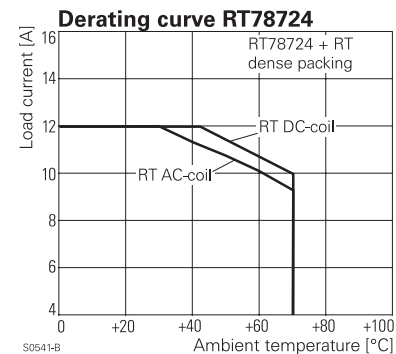

**Accessories Industrial Power Relay RT (Continued)**

Technical data (Continued)	RT 78 724 / RT 78 726	RT 78 725
Terminals	screw	
Terminal screw torque acc. IEC 61984	0.5 Nm	
max.	0.7 Nm	
Wire cross section		
single wire	2 x 2.5 mm <sup>2</sup>	
fine wire	2 x 2.5 mm <sup>2</sup>	
with bootlace crimp (DIN 46228/1)	2 x 1.5 mm <sup>2</sup>	
Insertion cycles	A (10)	
Max. Insertion Force total	100 N	
Mounting distance	≥ 0, dense packing	
Weight	36 g	
Packaging unit	10 pcs	

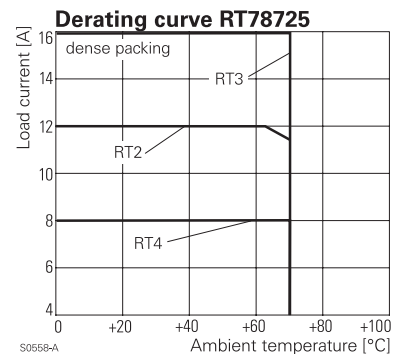

Socket with screw-type terminals for DIN rail mounting		
Type		Part Number
<b>RT 78 724</b>	Socket with screw-type terminals, pinning 3.5 mm for DIN rail mounting, logical terminal arrangement	8-1415035-1
<b>RT 78 726</b>	Socket with screw-type terminals, pinning 5 mm for DIN rail mounting, logical terminal arrangement	6-1415035-1
<b>RT 78 725</b>	Socket with screw-type terminals, pinning 5 mm for DIN rail mounting, conventional terminal arrangement	1860306-1

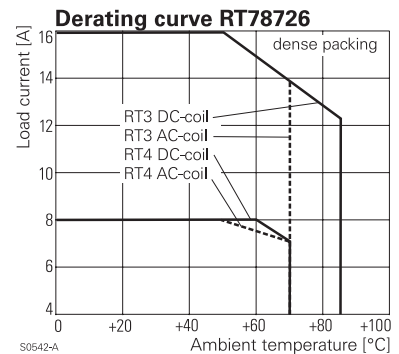

Accessories for RT 78 724, RT 78 725, RT 78 726		
Type		Part Number
<b>RT 17 017</b>	Plastic retaining clip, relay height 15.7	2022103-1
<b>RT 17 040</b>	Marking tag	2-1415038-1
<b>RT 17 0R8</b>	Jumper bar, max load 12 A for connection of up to 8 RT sockets	1860517-8

Jumper bar

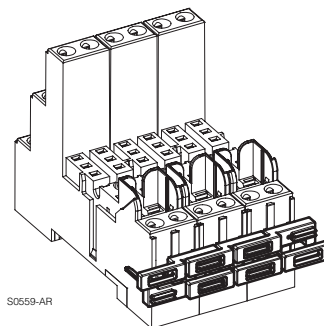

Marking tags

- White marking area 15.5 x 6 mm
- Snaps on socket in up to 4 positions

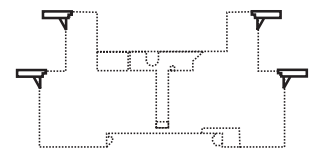
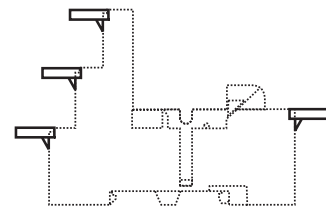

**Accessories Industrial Power Relay RT (Continued)**

**LED- and Protection Modules for RT 78 72P, RT 78 724, RT 78 725, RT 78 726**

Easy insertion of module into the socket  
Wiring in parallel to the coil

Type			Part Number
<b>PTM T0 0A0</b>	EM09	Protection diode (standard, A1+, A2-)	9-1415036-1
<b>PTM T0 0L0</b>	EM01	Protection diode (A1-, A2+)	1415037-1
<b>PTM U0 524</b>	EM02	RC-network 6...60 VAC	1-1415037-1
<b>PTM U0 730</b>	EM03	RC-network 110...230 VAC	2-1415037-1
<b>PTM V0 524</b>	EM04	Varistor 24 VAC	3-1415037-1
<b>PTM V0 615</b>	EM13	Varistor 115 VAC	6-1415365-1
<b>PTM V0 730</b>	EM05	Varistor 230 VAC	4-1415037-1
<b>PTM R0 730</b>	EM29	Bleeder Resistor 110...230 VAC	1-1415539-2



**LED**

<b>PTM L0 024</b>	EM18	red LED 6...24 VDC w. prot.diode (std, A1+, A2-)	5-1415036-1
<b>PTM G0 024</b>	EM12	green LED 6...24 VDC w. prot.diode (std, A1+, A2-)	2-1415036-1
<b>PTM L1 024</b>	EM08	red LED 6...24 VDC w. prot. diode (A1-, A2+)	8-1415036-1
<b>PTM L0 060</b>	EM16	red LED 24...60 VDC w. prot.diode (std, A1+, A2-)	5-1415539-3
<b>PTM G0 060</b>	EM25	green LED 24...60 VDC w. prot.diode (std, A1+, A2-)	7-1415539-7
<b>PTM L0 110</b>	EM19	red LED 60...110 VDC w. prot. diode (A1+, A2-)	2-1415392-1
<b>PTM G0 110</b>	EM26	green LED 60...110 VDC w. prot diode (A1+, A2-)	1-1415539-7
<b>PTM L0 220</b>	EM27	red LED 110...220 VDC w. prot. diode (A1+, A2-)	1-1415539-4
<b>PTM G0 220</b>	EM28	green LED 110...220 VDC w. prot diode (A1+, A2-)	1-1415539-6
<b>PTM L0 524</b>	EM07	red LED 6...24 VDC/VAC	6-1415036-1
<b>PTM G0 524</b>	EM11	green LED 6...24 VDC/VAC	3-1415036-1
<b>PTM L0 560</b>	EM14	red LED 24...60 VDC/VAC	1-1415539-3
<b>PTM G0 560</b>	EM30	green LED 24...60 VDC/VAC	1-1415539-5
<b>PTM L0 730</b>	EM06	red LED 110...230 VAC	7-1415036-1
<b>PTM G0 730</b>	EM10	green LED 110...230 VAC	4-1415036-1

**Relay Packages**

Complete packages consisting of a relay mounted on a socket: see Relay Package RT

**Accessories Industrial Power Relay RT (Continued)**

**Sockets for PCB mount**

**RP 78 601** Socket with PCB terminals, pinning 3.5 mm



F0116-A

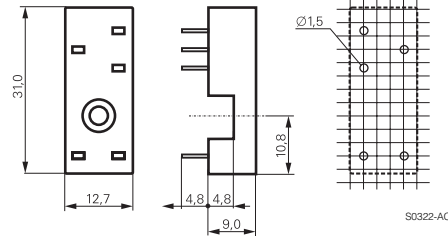

**RP 78 602** Socket with PCB terminals, pinning 5 mm



F0117-A

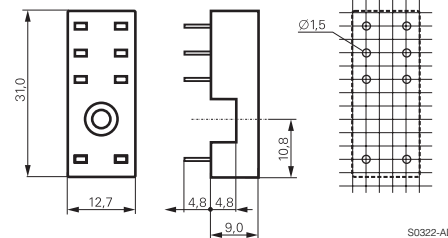

**Approvals**



Technical data		RP 78 601 / RP 78 602
Rated voltage / max. switching voltage AC		240 / 400 VAC
Rated current		12 A*)
Limiting continuous current		see derating curve
Dielectric strength coil-contact circuit		4000 V <sub>rms</sub>
open contact circuit		1000 V <sub>rms</sub>
adjacent contact circuits		2500 V <sub>rms</sub>
Clearance / creepage coil-contact circuit		≥ 10 / 10 mm
Material group of insulation parts		IIIa
Insulation to IEC 60664-1		
Type of insulation coil-contact circuit		reinforced
open contact circuit		functional
adjacent contact circuits		functional
Rated insulation voltage		250 V
Pollution degree		2
Rated voltage system		230 / 400 V
Overvoltage category		III
RoHS - Directive 2002/95/EC		compliant
Ambient temperature range		-40...+80°C
Terminals		pcb
Insertion cycles		A (10)
Max. Insertion Force total		100 N
Mounting distance		≥ 0, dense packing
Resistance to soldering heat		270°C / 10 s
Weight		3 g
Packaging unit		100 pcs

**Socket with PCB terminals**

Type	Part Number
<b>RP 78 601</b> Socket with PCB terminals, pinning 3.5 mm	8-1393234-4
<b>RP 78 602</b> Socket with PCB terminals, pinning 5 mm	8-1393234-5

**Accessories for RP 78 601, RP 78 602**

Type	Part Number
<b>RT 16 041</b> Plastic retaining clip RT, relay height 15.7 mm	3-1393161-4
<b>RT 28 516</b> Metal retaining clip RT, relay height 15.7 mm	1419108-7

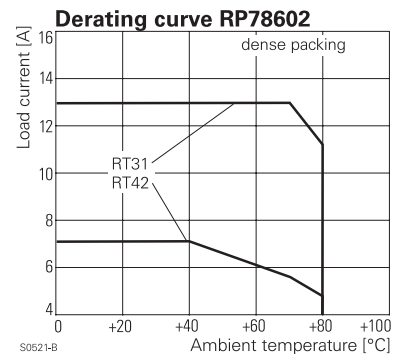
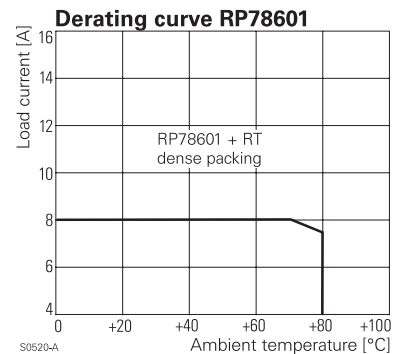

\*) For 1 pole relays (16 A) the relay terminals 11-21, 12-22 and 14-24 have to be bridged on the PCB.