

# SMD Inductors(Coils) For High Frequency(Multilayer)

Conformity to RoHS Directive

## MLK Series MLK1005

### FEATURES

- Inductance values are supported from 1 to 100nH.
- With the adoption of a giga-spiral laminated structure, self-resonant frequency higher than that of the MLG structure can be obtained, while the decrease of Q in the GHz band is limited.
- Advanced monolithic structure is formed using a multilayering and sintering process with ceramic and conductive materials for high-frequency.
- There is no directivity.
- The products contain no lead and also support lead-free soldering.
- It is a product conforming to RoHS directive.

### APPLICATIONS

For high-frequency applications including mobile phones, high frequency modules (PA, VCO, FEM etc.), Bluetooth, W-LAN, UWB and tuners.

### SHAPES AND DIMENSIONS

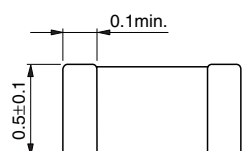
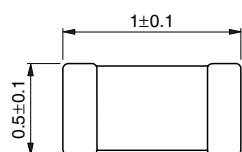

Weight: 1.0mg



### RECOMMENDED PC BOARD PATTERN

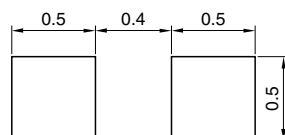

Dimensions in mm

### RECOMMENDED SOLDERING CONDITION REFLOW SOLDERING

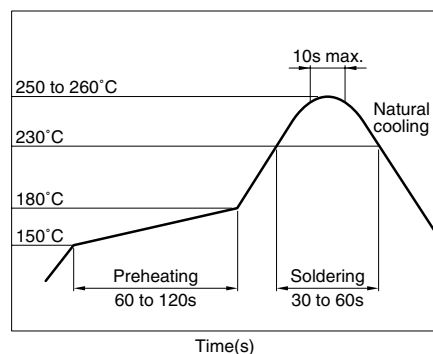

- Conformity to RoHS Directive: This means that, in conformity with EU Directive 2002/95/EC, lead, cadmium, mercury, hexavalent chromium, and specific bromine-based flame retardants, PBB and PBDE, have not been used, except for exempted applications.
- Please contact our Sales office when your application are considered the following:  
The device's failure or malfunction may directly endanger human life (e.g. application for automobile/aircraft/medical/nuclear power devices, etc.)

• All specifications are subject to change without notice.

### PRODUCT IDENTIFICATION

MLK	1005	S	2N2	S	T
(1)	(2)	(3)	(4)	(5)	(6)

(1) Series name

(2) Dimensions

1005	1.0×0.5mm (L×W)
------	-----------------

(3) Material code

(4) Inductance value

2N2	2.2nH
12N	12nH
R10	100nH

(5) Inductance tolerance

S	±0.3nH
D	±0.5nH
J	±5%

(6) Packaging style

T	Taping (reel)
---	---------------

### SPECIFICATIONS

Operating temperature range	-55 to +125°C
Storage temperature range	-55 to +125°C

### PACKAGING STYLE AND QUANTITIES

Packaging style	Quantity
Taping	10000 pieces/reel

### HANDLING AND PRECAUTIONS

- Before soldering, be sure to preheat components.  
The preheating temperature should be set so that the temperature difference between the solder temperature and product temperature does not exceed 150°C.
- After mounting components onto the printed circuit board, do not apply stress through board bending or mishandling.
- When hand soldering, apply the soldering iron to the printed circuit board only. Temperature of the iron tip should not exceed 350°C. Soldering time should not exceed 3 seconds.

**ELECTRICAL CHARACTERISTICS**

Inductance (nH)	Inductance tolerance	Q min.	Test frequency L, Q (MHz)	Self-resonant frequency (GHz)		DC resistance ( $\Omega$ )		Rated current (mA)max.	Part No.*
				min.	typ.	max.	typ.		
1.0	$\pm 0.3$ nH	5	100	12.0	16.9	0.10	0.05	500	MLK1005S1N0□□
1.1	$\pm 0.3$ nH	5	100	11.5	14.8	0.12	0.05	500	MLK1005S1N1□□
1.2	$\pm 0.3$ nH	5	100	11.0	14.4	0.12	0.05	500	MLK1005S1N2□□
1.3	$\pm 0.3$ nH	5	100	10.0	12.6	0.15	0.06	500	MLK1005S1N3□□
1.5	$\pm 0.3$ nH	6	100	9.5	12.2	0.15	0.06	500	MLK1005S1N5□□
1.6	$\pm 0.3$ nH	6	100	9.0	11.8	0.17	0.07	500	MLK1005S1N6□□
1.8	$\pm 0.3$ nH	6	100	8.5	10.9	0.17	0.07	500	MLK1005S1N8□□
2.0	$\pm 0.3$ nH	6	100	8.3	9.9	0.18	0.08	500	MLK1005S2N0□□
2.2	$\pm 0.3$ nH	6	100	8.0	9.6	0.18	0.08	500	MLK1005S2N2□□
2.4	$\pm 0.3$ nH	6	100	7.8	9.5	0.20	0.09	500	MLK1005S2N4□□
2.7	$\pm 0.3$ nH	6	100	7.5	9.1	0.20	0.10	500	MLK1005S2N7□□
3.0	$\pm 0.3$ nH	6	100	7.2	8.4	0.22	0.11	400	MLK1005S3N0□□
3.3	$\pm 0.3$ nH	7	100	7.0	8.3	0.22	0.11	400	MLK1005S3N3□□
3.6	$\pm 0.3$ nH	7	100	6.8	8.1	0.25	0.12	400	MLK1005S3N6□□
3.9	$\pm 0.3$ nH	7	100	6.5	7.8	0.25	0.12	400	MLK1005S3N9□□
4.3	$\pm 0.3$ nH	7	100	6.3	7.4	0.28	0.13	400	MLK1005S4N3□□
4.7	$\pm 0.3$ nH	7	100	6.0	6.9	0.28	0.13	400	MLK1005S4N7□□
5.1	$\pm 0.3$ nH	7	100	5.8	6.9	0.30	0.15	400	MLK1005S5N1□□
5.6	$\pm 0.3$ nH, 0.5nH	7	100	5.7	6.7	0.30	0.15	400	MLK1005S5N6□□
6.2	$\pm 0.3$ nH, 0.5nH	7	100	5.6	6.4	0.35	0.19	400	MLK1005S6N2□□
6.8	$\pm 5\%$ , 0.5nH	7	100	5.5	6.3	0.35	0.18	400	MLK1005S6N8□□
7.5	$\pm 5\%$ , 0.5nH	7	100	5.0	6.0	0.38	0.21	350	MLK1005S7N5□□
8.2	$\pm 5\%$ , 0.5nH	7	100	5.0	6.0	0.38	0.21	350	MLK1005S8N2□□
9.1	$\pm 5\%$	7	100	4.8	5.8	0.42	0.24	350	MLK1005S9N1□□
10	$\pm 5\%$	7	100	4.7	5.2	0.42	0.23	350	MLK1005S10N□□
12	$\pm 5\%$	7	100	4.3	5.3	0.47	0.27	350	MLK1005S12NJ□□
15	$\pm 5\%$	7	100	4.0	4.8	0.50	0.33	300	MLK1005S15NJ□□
18	$\pm 5\%$	7	100	4.0	4.7	0.60	0.38	250	MLK1005S18NJ□□
22	$\pm 5\%$	7	100	3.5	4.4	0.70	0.46	200	MLK1005S22NJ□□
27	$\pm 5\%$	7	100	3.0	3.9	0.80	0.53	200	MLK1005S27NJ□□
33	$\pm 5\%$	7	100	2.5	3.5	0.90	0.59	200	MLK1005S33NJ□□
39	$\pm 5\%$	6	100	2.0	3.1	1.00	0.65	200	MLK1005S39NJ□□
47	$\pm 5\%$	6	100	1.8	3.0	1.20	0.74	200	MLK1005S47NJ□□
56	$\pm 5\%$	6	100	1.5	2.6	1.30	0.84	200	MLK1005S56NJ□□
68	$\pm 5\%$	6	100	1.4	2.4	1.50	1.01	150	MLK1005S68NJ□□
82	$\pm 5\%$	6	100	1.3	2.2	1.80	1.39	150	MLK1005S82NJ□□
100	$\pm 5\%$	6	100	1.1	1.9	2.20	1.60	100	MLK1005SR10J□□

\* □: Please specify inductance tolerance, S ( $\pm 3$ nH), D ( $\pm 0.5$ nH) or J ( $\pm 5\%$ ).

• Test equipment

Inductance Q : HP4291A+16193A, or equivalent

SRF: HP8720C, or equivalent

Rdc: YOKOGAWA TYPE7561, or equivalent

## L, Q vs. FREQUENCY CHARACTERISTICS

Part No.	Inductance(nH)typ.					Q typ.				
	500MHz	800MHz	1.8GHz	2.0GHz	2.4GHz	500MHz	800MHz	1.8GHz	2.0GHz	2.4GHz
MLK1005S1N0	0.9	0.9	0.9	0.9	0.9	16	20	30	32	36
MLK1005S1N1	1.0	1.0	1.0	1.0	1.0	16	20	32	35	39
MLK1005S1N2	1.1	1.1	1.1	1.1	1.1	15	18	28	30	33
MLK1005S1N3	1.2	1.2	1.2	1.2	1.2	17	20	33	35	39
MLK1005S1N5	1.4	1.4	1.4	1.4	1.4	15	19	29	31	34
MLK1005S1N6	1.5	1.5	1.5	1.5	1.5	17	21	34	36	40
MLK1005S1N8	1.7	1.7	1.7	1.7	1.7	16	21	32	33	37
MLK1005S2N0	1.9	1.8	1.9	1.9	1.9	16	20	32	34	38
MLK1005S2N2	2.0	2.0	2.0	2.0	2.1	15	19	29	31	34
MLK1005S2N4	2.2	2.2	2.2	2.3	2.3	16	20	32	34	38
MLK1005S2N7	2.5	2.5	2.5	2.6	2.6	17	22	33	35	39
MLK1005S3N0	2.8	2.8	2.8	2.9	2.9	18	22	35	36	41
MLK1005S3N3	3.1	3.1	3.1	3.1	3.2	16	20	31	32	36
MLK1005S3N6	3.4	3.3	3.4	3.5	3.5	17	22	33	35	39
MLK1005S3N9	3.7	3.6	3.7	3.7	3.8	17	21	32	33	37
MLK1005S4N3	4.0	4.0	4.1	4.2	4.3	17	22	34	35	39
MLK1005S4N7	4.4	4.4	4.5	4.6	4.7	17	22	33	35	38
MLK1005S5N1	4.8	4.8	4.9	5.0	5.1	17	22	33	35	38
MLK1005S5N6	5.3	5.2	5.4	5.5	5.7	17	22	33	34	38
MLK1005S6N2	5.8	5.8	6.0	6.2	6.4	18	23	34	35	39
MLK1005S6N8	6.4	6.4	6.6	6.7	7.0	17	22	32	33	36
MLK1005S7N5	7.1	7.0	7.4	7.6	7.9	18	23	34	36	38
MLK1005S8N2	7.7	7.7	8.1	8.3	8.6	19	23	34	36	38
MLK1005S9N1	8.6	8.6	9.1	9.3	9.7	18	23	34	36	38
MLK1005S10N	9.4	9.4	10.0	10.2	10.7	19	23	34	35	38
MLK1005S12N	11.3	11.3	12.1	12.4	13.0	19	23	34	35	37
MLK1005S15N	14.2	14.2	15.3	15.8	16.8	18	23	33	34	35
MLK1005S18N	17.0	17.1	18.6	19.2	20.6	18	23	32	33	34
MLK1005S22N	20.8	20.9	23.0	23.9	25.8	18	23	32	33	34
MLK1005S27N	25.6	25.9	29.8	31.5	35.7	18	23	30	30	28
MLK1005S33N	31.4	31.9	37.6	40.2		18	23	29	29	
MLK1005S39N	37.2	38.1	48.9			17	21	24		
MLK1005S47N	45.0	46.2	60.6			18	21	24		
MLK1005S56N	53.7	55.4	76.7			17	21	22		
MLK1005S68N	65.4	68.1	102.3			17	20	19		
MLK1005S82N	79.4	83.3	137.7			16	19	17		
MLK1005SR10	97.4	103.7	204.7			16	19	14		

## TYPICAL ELECTRICAL CHARACTERISTICS

### INDUCTANCE vs. FREQUENCY CHARACTERISTICS

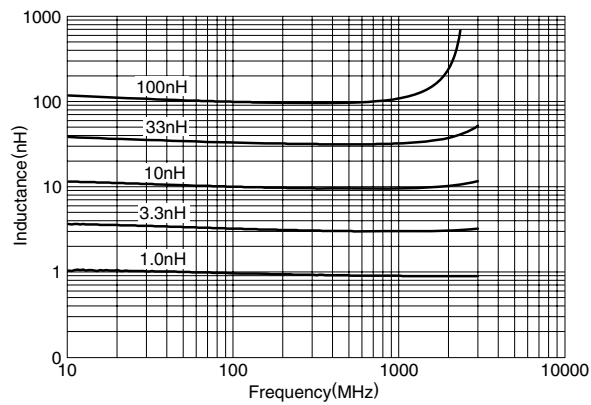

### Q vs. FREQUENCY CHARACTERISTICS

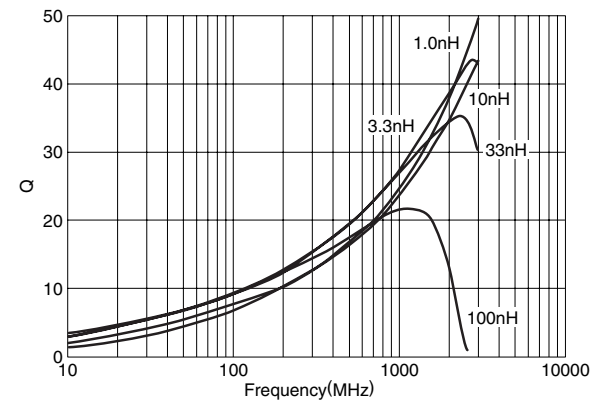

• All specifications are subject to change without notice.

### PACKAGING STYLES REEL DIMENSIONS

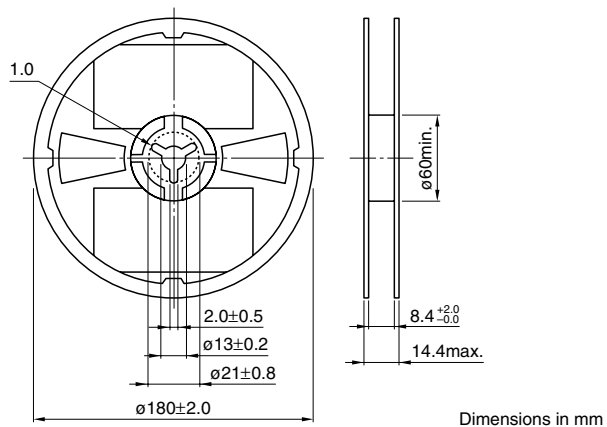

### TAPE DIMENSIONS

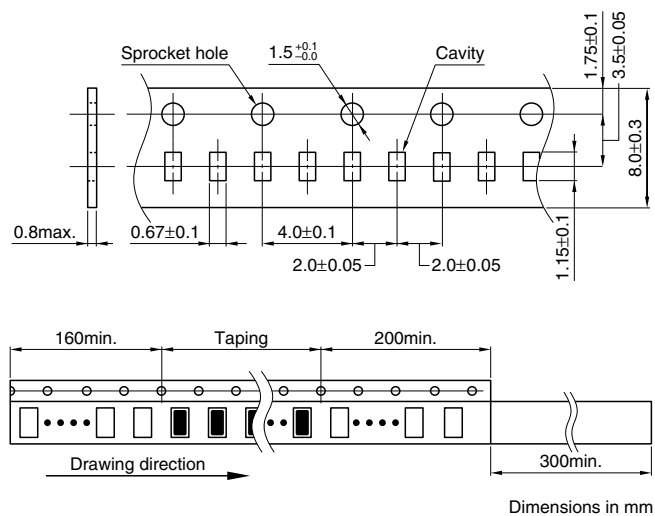

• All specifications are subject to change without notice.