

# 14.2 mm (0.56 inch) Seven Segment Displays

## Technical Data

**HDSP-K40x Series**  
**HDSP-550x Series**  
**HDSP-552x Series**  
**HDSP-560x Series**  
**HDSP-562x Series**  
**HDSP-570x Series**  
**HDSP-572x Series**  
**HDSP-H15x Series**  
**HDSP-H40x Series**

### Features

- **Industry Standard Size**
- **Industry Standard Pinout**  
15.24 mm (0.6 in.) DIP Leads  
on 2.54 mm (0.1 in.) Centers
- **Choice of Colors**  
AlGaAs Red, High Efficiency  
Red, Yellow, Green, Orange
- **Excellent Appearance**  
Evenly Lighted Segments  
Mitered Corners on Segments  
Gray Package Gives Optimum  
Contrast  
± 50° Viewing Angle
- **Design Flexibility**  
Common Anode or Common  
Cathode  
Single and Dual Digits  
Right Hand Decimal Point  
± 1. Overflow Character

- **Categorized for Luminous Intensity**  
Yellow and Green Categorized  
for Color  
Use of Like Categories Yields a  
Uniform Display
- **High Light Output**
- **High Peak Current**
- **Excellent for Long Digit String Multiplexing**
- **Intensity and Color Selection Option**  
See Intensity and Color  
Selected Displays Data Sheet
- **Sunlight Viewable AlGaAs**

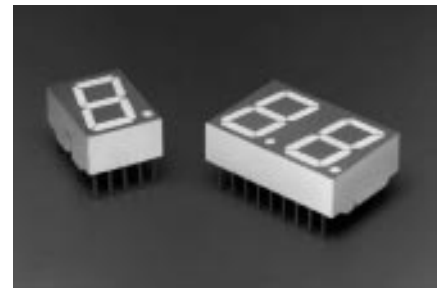

### Description

The 14.2 mm (0.56 inch) LED seven segment displays are designed for viewing distances up

to 7 metres (23 feet). These devices use an industry standard size package and pinout. Both the numeric and ± 1 overflow devices feature a right hand decimal point. All devices are available as either common anode or common cathode.

### Devices

Orange HDSP-	AlGaAs Red HDSP-[1]	HER HDSP-[1]	Yellow HDSP-	Green HDSP-	Description	Package Drawing
H401	H151	5501	5701	5601	Common Anode Right Hand Decimal	A
H403	H153	5503	5703	5603	Common Cathode Right Hand Decimal	B
	H157	5507	5707	5607	Common Anode ± 1. Overflow	C
	H158	5508	5708	5608	Common Cathode ± 1. Overflow	D
K401		5521	5721	5621	Two Digit Common Anode Right Hand Decimal	E
K403		5523	5723	5623	Two Digit Common Cathode Right Hand Decimal	F

#### Note:

1. These displays are recommended for high ambient light operation. Please refer to the HDSP-H10X/K12X AlGaAs and HDSP-555X HER data sheet for low current operation.

These displays are ideal for most applications. Pin for pin equivalent displays are also available in a low current design. The low current displays are ideal

for portable applications. For additional information see the Low Current Seven Segment Displays data sheet.

## Part Numbering System

5082 -X X X X-X X X X X  
 HDSP-X X X X-X X X X X

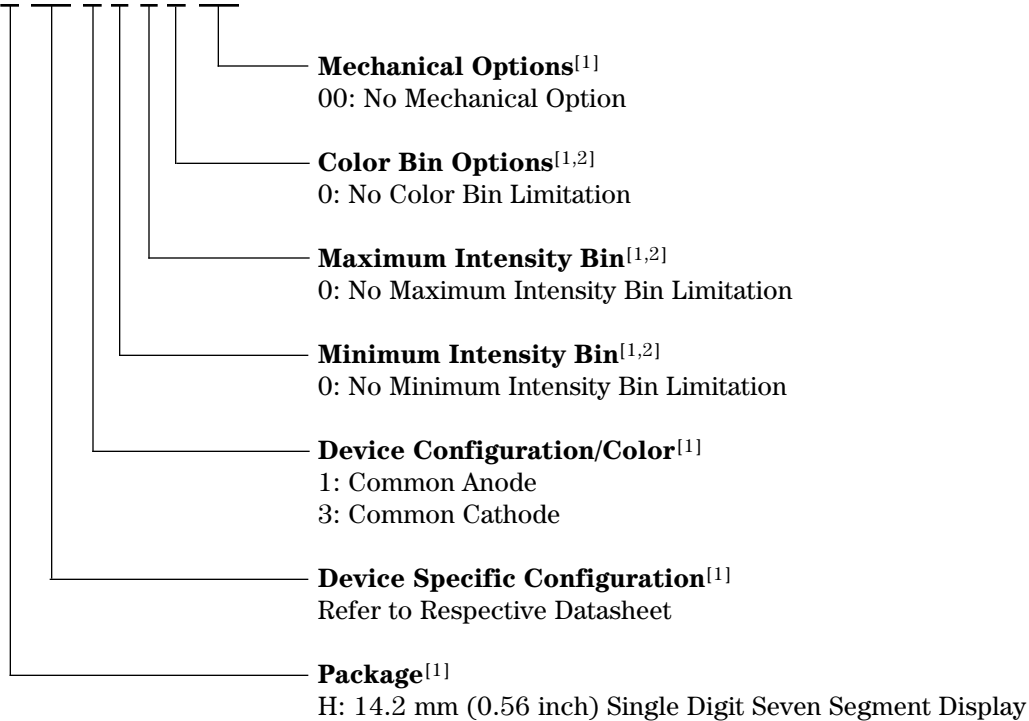

### Notes:

1. For codes not listed in the figure above, please refer to the respective datasheet or contact your nearest Agilent representative for details.
2. Bin options refer to shippable bins for a part number. Color and Intensity Bins are typically restricted to 1 bin per tube (exceptions may apply). Please refer to respective datasheet for specific bin limit information.

## Package Dimensions

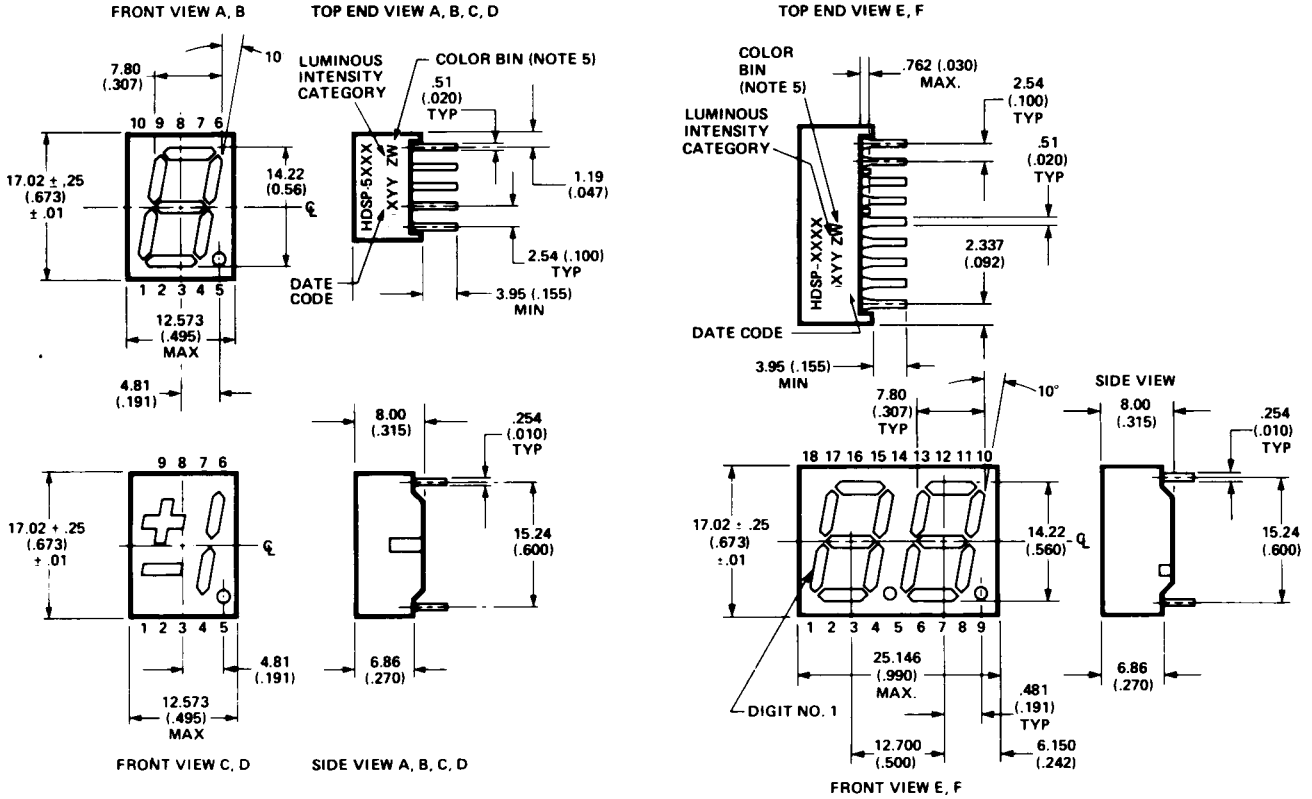

PIN	FUNCTION					
	A	B	C	D	E	F
1	CATHODE e	ANODE e	CATHODE c	ANODE c	E CATHODE NO. 1	E ANODE NO. 1
2	CATHODE d	ANODE d	ANODE c, d	CATHODE c, d	D CATHODE NO. 1	D ANODE NO. 1
3	ANODE <sup>[3]</sup>	CATHODE <sup>[4]</sup>	CATHODE b	ANODE b	C CATHODE NO. 1	C ANODE NO. 1
4	CATHODE c	ANODE c	ANODE a, b, DP	CATHODE a, b, DP	DP CATHODE NO. 1	DP ANODE NO. 1
5	CATHODE DP	ANODE DP	CATHOPDE DP	ANODE DE	E CATHODE NO. 1	E ANODE NO. 2
6	CATHODE b	ANODE b	CATHODE a	ANODE a	D CATHODE NO. 2	D ANODE NO. 2
7	CATHODE a	ANODE a	ANODE a, b, DP	CATHODE a, b, DP	G CATHODE NO. 2	G ANODE NO. 2
8	ANODE <sup>[3]</sup>	CATHODE <sup>[4]</sup>	ANODE c, d	CATHODE c, d	C CATHODE NO. 2	C ANODE NO. 2
9	CATHODE f	ANODE f	CATHODE d	ANODE d	DP CATHODE NO. 2	DP ANODE NO. 2
10	CATHODE g	ANODE g	NO PIN	NO PIN	B CATHODE NO. 2	B ANODE NO. 2
11					A CATHODE NO. 2	A ANODE NO. 2
12					F CATHODE NO. 2	F ANODE NO. 2
13					DIGIT NO. 2 ANODE	DIGIT NO. 2 CATHODE
14					DIGIT NO. 1 ANODE	DIGIT NO. 1 CATHODE
15					B CATHODE NO. 1	B ANODE NO. 1
16					A CATHODE NO. 1	A ANODE NO. 1
17					G CATHODE NO. 1	G ANODE NO. 1
18					F CATHODE NO. 1	F ANODE NO. 1

**NOTES:**

- ALL DIMENSIONS IN MILLIMETRES (INCHES).
- ALL UNTOLERANCED DIMENSIONS ARE FOR REFERENCE ONLY.
- REDUNDANT ANODES.
- REDUNDANT CATHODES.
- FOR HDSP-5600/-5700 SERIES PRODUCT ONLY.

## Internal Circuit Diagram

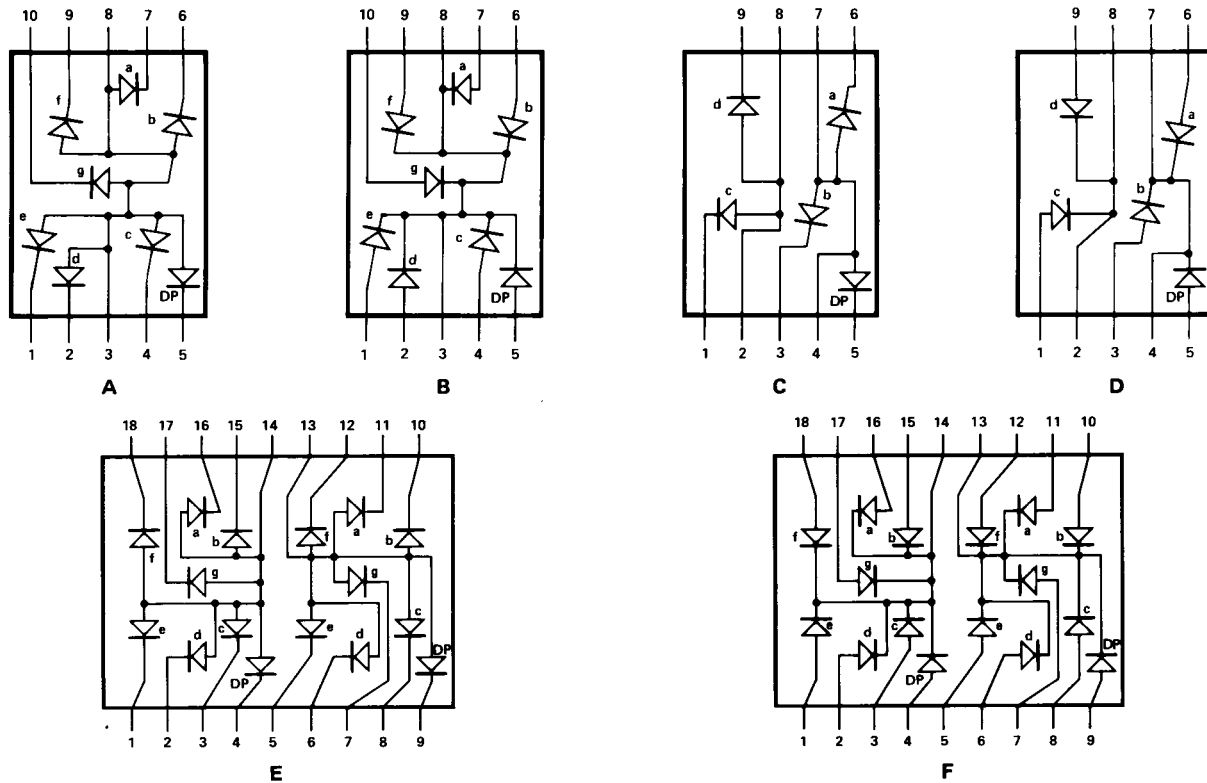

## Absolute Maximum Ratings

Description	AlGaAs Red HDSP-H150 Series	HER/Orange HDSP-5500 HDSP-H40x HDSP-K40x Series	Yellow HDSP-5700 Series	Green HDSP-5600 Series	Units
Average Power per Segment or DP	96	105	80	105	mW
Peak Forward Current per Segment or DP	160 <sup>[1]</sup>	90 <sup>[3]</sup>	60 <sup>[5]</sup>	90 <sup>[7]</sup>	mA
DC Forward Current per Segment or DP	40 <sup>[2]</sup>	30 <sup>[4]</sup>	20 <sup>[6]</sup>	30 <sup>[8]</sup>	mA
Operating Temperature Range	-20 to +100 <sup>[9]</sup>	-40 to +100			°C
Storage Temperature Range	-55 to +100				°C
Reverse Voltage per Segment or DP	3.0				V
Lead Solder Temperature for 3 Seconds (1.60 mm [0.063 in.] below seating plane)	260				°C

### Notes:

- See Figure 2 to establish pulsed conditions.
- Derate above 46°C at 0.54 mA/°C.
- See Figure 7 to establish pulsed conditions.
- Derate above 53°C at 0.45 mA/°C.
- See Figure 8 to establish pulsed conditions.
- Derate above 81°C at 0.52 mA/°C.
- See Figure 9 to establish pulsed conditions.
- Derate above 39°C at 0.37 mA/°C.
- For operation below -20°C, contact your local Agilent components sales office or an authorized distributor.

## Electrical/Optical Characteristics at $T_A = 25^\circ\text{C}$

### AlGaAs Red

Device Series HDSP-	Parameter	Symbol	Min.	Typ.	Max.	Units	Test Conditions
H15X	Luminous Intensity/Segment <sup>[1,2,5]</sup> (Digit Average)	$I_V$	9.1	16.0		mc	$I_F = 20 \text{ mA}$
	Forward Voltage/Segment or DP	$V_F$		1.8		V	$I_F = 20 \text{ mA}$
				2.0	3.0		$I_F = 100 \text{ mA}$
	Peak Wavelength	$\lambda_{\text{PEAK}}$		645		nm	
	Dominant Wavelength <sup>[3]</sup>	$\lambda_d$		637		nm	
	Reverse Voltage/Segment or DP <sup>[4]</sup>	$V_R$	3.0	15		V	$I_R = 100 \mu\text{A}$
	Temperature Coefficient of $V_F$ /Segment or DP	$\Delta V_F/^\circ\text{C}$		-2		mV/°C	
Thermal Resistance LED Junction-to-Pin	$R\theta_{\text{J-Pin}}$		400		°C/W/Seg		

### High Efficiency Red

Device Series HDSP-	Parameter	Symbol	Min.	Typ.	Max.	Units	Test Conditions
55XX	Luminous Intensity/Segment <sup>[1,2,6]</sup> (Digit Average)	$I_V$	900	2800		$\mu\text{cd}$	$I_F = 10 \text{ mA}$
				3700			$I_F = 60 \text{ mA Peak: 1 of 6 df}$
	Forward Voltage/Segment or DP	$V_F$		2.1	2.5	V	$I_F = 20 \text{ mA}$
	Peak Wavelength	$\lambda_{\text{PEAK}}$		635		nm	
	Dominant Wavelength <sup>[3]</sup>	$\lambda_d$		626		nm	
	Reverse Voltage/Segment or DP <sup>[4]</sup>	$V_R$	3.0	30		V	$I_R = 100 \mu\text{A}$
	Temperature Coefficient of $V_F$ /Segment or DP	$\Delta V_F/^\circ\text{C}$		-2		mV/°C	
Thermal Resistance LED Junction-to-Pin	$R\theta_{\text{J-Pin}}$		345		°C/W/Seg		

**Yellow**

Device Series HDSP-	Parameter	Symbol	Min.	Typ.	Max.	Units	Test Conditions
57XX	Luminous Intensity/Segment <sup>[1,2]</sup> (Digit Average)	I <sub>V</sub>	600	1800		μcd	I <sub>F</sub> = 10 mA
				2750			I <sub>F</sub> = 60 mA Peak: 1 of 6 df
	Forward Voltage/Segment or DP	V <sub>F</sub>		2.1	2.5	V	I <sub>F</sub> = 20 mA
	Peak Wavelength	λ <sub>PEAK</sub>		583		nm	
	Dominant Wavelength <sup>[3,7]</sup>	λ <sub>d</sub>	581.5	586	592.5	nm	
	Reverse Voltage/Segment or DP <sup>[4]</sup>	V <sub>R</sub>	3.0	40		V	I <sub>R</sub> = 100 μA
	Temperature Coefficient of V <sub>F</sub> /Segment or DP	ΔV <sub>F</sub> /°C		-2		mV/°C	
Thermal Resistance LED Junction-to-Pin	Rθ <sub>J-Pin</sub>		345		°C/W/ Seg		

**Orange**

Device Series HDSP-	Parameter	Symbol	Min.	Typ.	Max.	Units	Test Conditions
H40x K40x	Luminous Intensity/Segment (Segment Average) <sup>[1,2]</sup>	I <sub>V</sub>		2.37		mcd	I <sub>F</sub> = 10 mA
	Forward Voltage/Segment or DP	V <sub>F</sub>		2.1	2.5	V	I <sub>F</sub> = 20 mA
	Peak Wavelength	λ <sub>PEAK</sub>		600		nm	
	Dominant Wavelength <sup>[3]</sup>	λ <sub>d</sub>		603		nm	I <sub>F</sub> = 10 mA
	Reverse Voltage/Segment or DP <sup>[4]</sup>	V <sub>R</sub>	3.0	30		V	I <sub>R</sub> = 100 μA
	Temperature Coefficient of V <sub>F</sub> /Segment or DP	ΔV <sub>F</sub> /°C		-2		mV/°C	
	Thermal Resistance LED Junction-to-Pin	Rθ <sub>J-Pin</sub>		345		°C/W/ Seg	

## High Performance Green

Device Series HDSP-	Parameter	Symbol	Min.	Typ.	Max.	Units	Test Conditions
56XX	Luminous Intensity/Segment <sup>[1,2]</sup> (Digit Average)	$I_V$	900	2500		$\mu\text{cd}$	$I_F = 10 \text{ mA}$
				3100			$I_F = 60 \text{ mA Peak:}$ 1 of 6 df
	Forward Voltage/Segment or DP	$V_F$		2.1	2.5	V	$I_F = 10 \text{ mA}$
	Peak Wavelength	$\lambda_{\text{PEAK}}$		566		nm	
	Dominant Wavelength <sup>[3,7]</sup>	$\lambda_d$		571	577	nm	
	Reverse Voltage/Segment or DP <sup>[4]</sup>	$V_R$	3.0	50		V	$I_R = 100 \mu\text{A}$
	Temperature Coefficient of $V_F$ /Segment or DP	$\Delta V_F/^\circ\text{C}$		-2		mV/°C	
Thermal Resistance LED Junction-to-Pin	$R\theta_{\text{J-Pin}}$		345		°C/W/ Seg		

### Notes:

1. Device case temperature is 25°C prior to the intensity measurement.
2. The digits are categorized for luminous intensity. The intensity category is designated by a letter on the side of the package.
3. The dominant wavelength,  $\lambda_d$ , is derived from the CIE chromaticity diagram and is that single wavelength which defines the color of the device.
4. Typical specification for reference only. Do not exceed absolute maximum ratings.
5. For low current operation, the AlGaAs HDSP-H10X series displays are recommended. They are tested at 1 mA dc/segment and are pin for pin compatible with the HDSP-H15X series.
6. For low current operation, the HER HDSP-555X series displays are recommended. They are tested at 2 mA dc/segment and are pin for pin compatible with the HDSP-550X series.
7. The Yellow (HDSP-5700) and Green (HDSP-5600) displays are categorized for dominant wavelength. The category is designated by a number adjacent to the luminous intensity category letter.

## AlGaAs Red

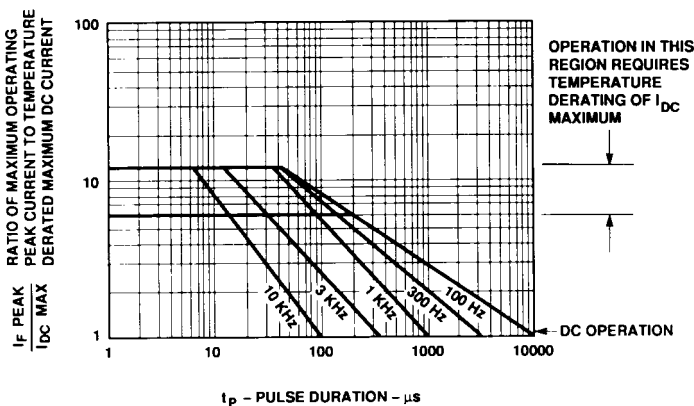

Figure 1. Maximum Tolerable Peak Current vs. Pulse Duration - Red.

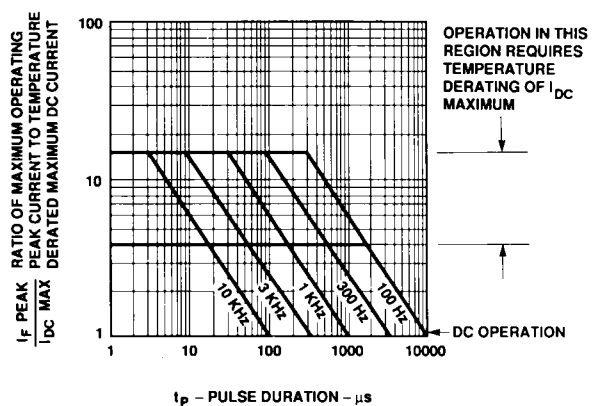

Figure 2. Maximum Tolerable Peak Current vs. Pulse Duration - AlGaAs Red.

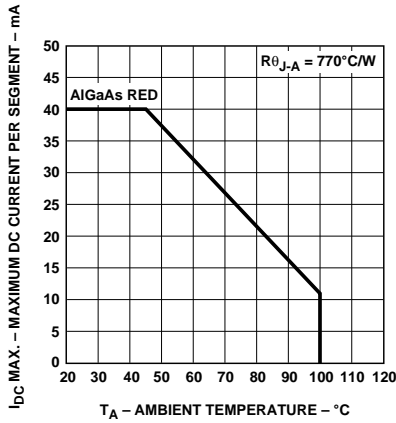

Figure 3. Maximum Allowable DC Current vs. Ambient Temperature.

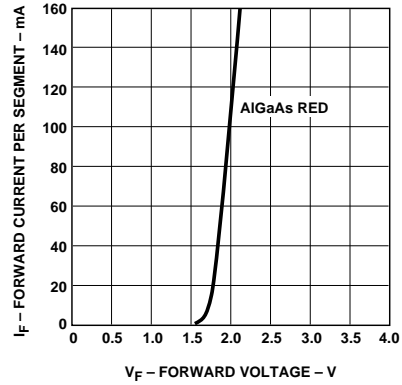

Figure 4. Forward Current vs. Forward Voltage.

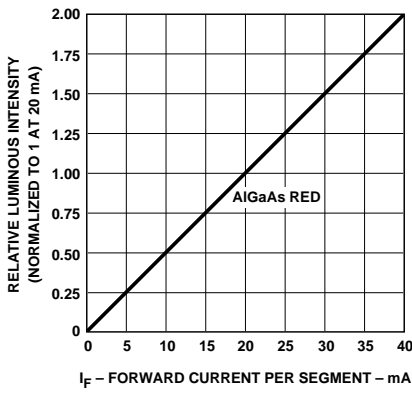

Figure 5. Relative Luminous Intensity vs. DC Forward Current.

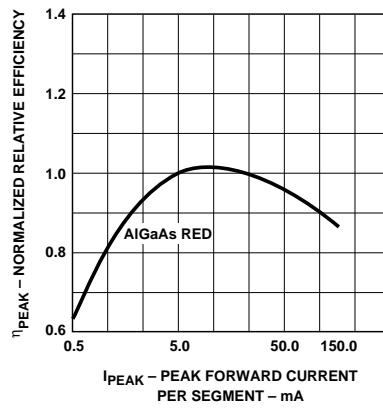

Figure 6. Relative Efficiency (Luminous Intensity per Unit Current) vs. Peak Current.

### HER, Yellow, Green, Orange

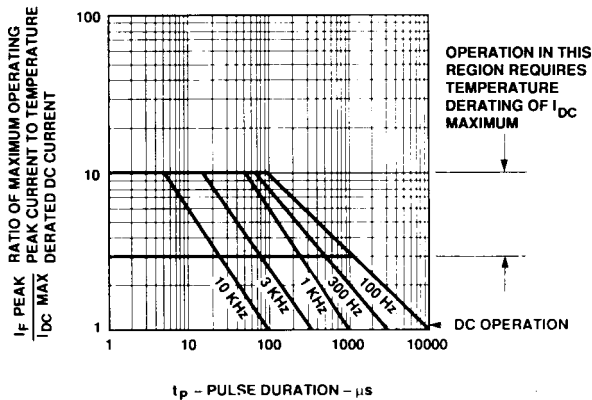

Figure 7. Maximum Tolerable Peak Current vs. Pulse Duration - HER, Orange.

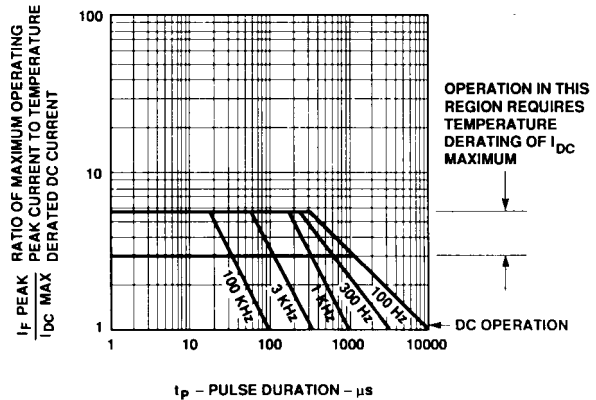

Figure 8. Maximum Tolerable Peak Current vs. Pulse Duration - Yellow.



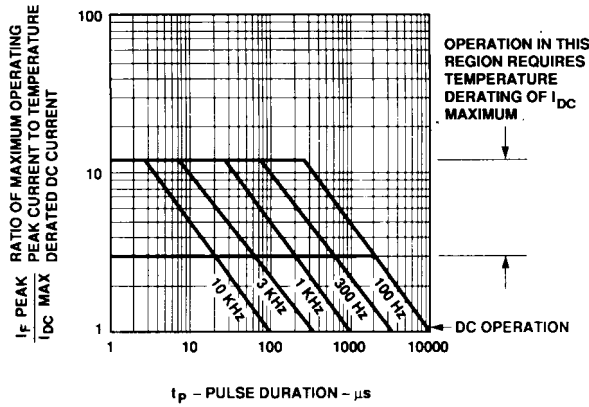

Figure 9. Maximum Tolerable Peak Current vs. Pulse Duration - Green.

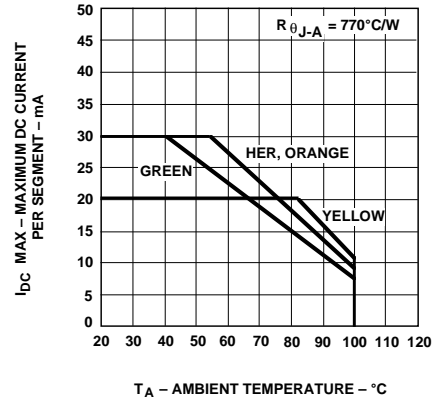

Figure 10. Maximum Allowable DC Current vs. Ambient Temperature.

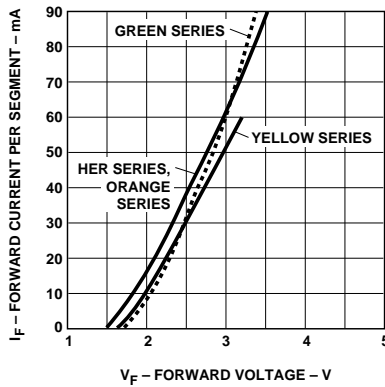

Figure 11. Forward Current vs. Forward Voltage.

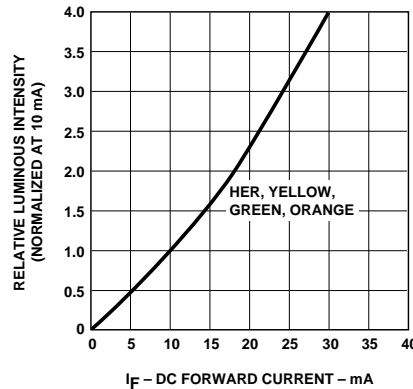

Figure 12. Relative Luminous Intensity vs. DC Forward Current.

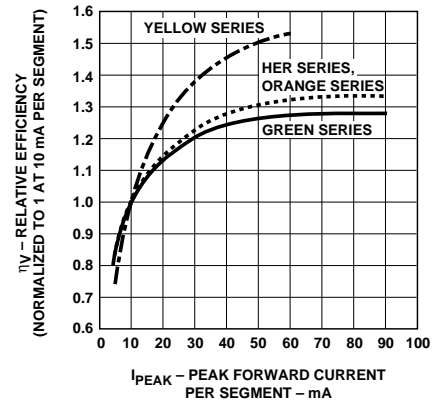

Figure 13. Relative Efficiency (Luminous Intensity per Unit Current) vs. Peak Current.

### Electrical/Optical

For more information on electrical/optical characteristics, please see Application Note 1005.

### Contrast Enhancement

For information on contrast enhancement please see Application Note 1015.

### Soldering/Cleaning

Cleaning agents from the ketone family (acetone, methyl ethyl ketone, etc.) and from the chlorinated hydrocarbon family

(methylene chloride, trichloroethylene, carbon tetrachloride, etc.) are not recommended for cleaning LED parts. All of these various solvents attack or dissolve the encapsulating epoxies used to form the package of plastic LED parts.

For information on soldering LEDs please refer to Application Note 1027.

**Intensity Bin Limits (mcd)****AlGaAs Red**

<b>HDSP-H15x</b>		
<b>IV Bin Category</b>	<b>Min.</b>	<b>Max.</b>
K	9.20	16.90
L	13.80	25.30
M	20.70	38.00
N	31.10	56.90
O	46.60	85.40

**HER**

<b>HDSP-550x/552x</b>		
<b>IV Bin Category</b>	<b>Min.</b>	<b>Max.</b>
E	0.91	1.67
F	1.37	2.51
G	2.05	3.76
H	3.08	5.64
I	4.62	8.64
J	6.93	12.70
K	10.39	19.04

**Yellow**

<b>HDSP-570x/572x</b>		
<b>IV Bin Category</b>	<b>Min.</b>	<b>Max.</b>
D	0.61	1.11
E	0.91	1.67
F	1.37	2.51
G	2.05	3.76
H	3.08	5.64
I	4.62	8.64
J	6.93	12.70
K	10.39	19.04

**Green**

<b>HDSP-560x/562x</b>		
<b>IV Bin Category</b>	<b>Min.</b>	<b>Max.</b>
E	0.91	1.67
F	1.37	2.51
G	2.05	3.76
H	3.08	5.64
I	4.61	8.46

**Orange**

<b>HDSP-H40x/K40x</b>		
<b>IV Bin Category</b>	<b>Min.</b>	<b>Max.</b>
B	0.77	1.17
C	0.95	1.45
D	1.19	1.82
E	1.49	2.27
F	1.85	2.89
G	2.32	3.54
H	2.90	4.43

**Color Categories**

<b>Color</b>	<b>Bin</b>	<b>Dominant Wavelength (nm)</b>	
		<b>Min.</b>	<b>Max.</b>
Yellow	1	581.50	585.00
	3	584.00	587.50
	2	586.50	590.00
	4	589.00	592.50
Green	2	573.00	577.00
	3	570.00	574.00
	4	567.00	571.00
	5	564.00	568.00

**Note:**

All categories are established for classification of products. Products may not be available in all categories. Please contact your Agilent representatives for further clarification/information.

**[www.agilent.com/semiconductors](http://www.agilent.com/semiconductors)**

For product information and a complete list of distributors, please go to our web site.

For technical assistance call:

Americas/Canada: +1 (800) 235-0312 or  
(408) 654-8675

Europe: +49 (0) 6441 92460

China: 10800 650 0017

Hong Kong: (+65) 271 2451

India, Australia, New Zealand: (+65) 271 2394

Japan: (+81 3) 3335-8152(Domestic/International), or 0120-61-1280(Domestic Only)

Korea: (+65) 271 2194

Malaysia, Singapore: (+65) 271 2054

Taiwan: (+65) 271 2654

Data subject to change.

Copyright © 2002 Agilent Technologies, Inc.

Obsoletes 5988-0383EN

January 17, 2002

5988-4273EN