

PRELIMINARY INFORMATION

FEATURES

- Wide Input Voltage Operating Range from 2.5V to 60V
- Low Standby Current
- Current Limiting
- Output Switch Current of 1.5A
- Output Voltage Adjustable from 1.25 to 40V
- Frequency of Operation to 100kHz
- Thermal Protection
- Enable Input Pin

APPLICATIONS

- Step-Up Converter
- Step-Down Converter
- Voltage Inverting Application
- Telephone Circuits
- Monitors
- Battery Chargers
- Portable Equipment

GENERAL DESCRIPTION

The AMS36063 series is a control circuit containing the basic functions required for DC-to-DC converters. The device consists of an internal temperature compensated reference, a comparator, a controlled duty cycle oscillator with an active current limit circuit, a driver, a high current output switch, a thermal protection circuit and a converter enable input. Designed specifically to be incorporated in Step-Up, Step-Down and Voltage -Inverting applications, the AMS36063 requires a minimum number of external components.

The AMS36063 is available in the 8-lead plastic SOIC and 8-lead plastic DIP packages.

ORDERING INFORMATION

PACKAGE TYPE		OPER. TEMP RANGE
8 LEAD PDIP	8 LEAD SOIC	
AMS36063P	AMS36063S	-40°C to +85°C

PIN CONNECTIONS

8 LEAD SOIC/ 8 LEAD PDIP

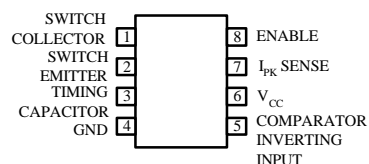

Top View

ABSOLUTE MAXIMUM RATINGS (Note 1)

Power Supply Voltage, V_{CC}	60V	Driver Collector Voltage, $V_{C(driver)}$	60V
Comparator Input Voltage Range, V_{IR}	-0.3V to +60V	Switch Current, I_{SW}	1.5A
Switch Collector Voltage, $V_{C(switch)}$	60V	Power Dissipation	(Note 3)
Switch Emitter Voltage, $V_{E(switch)}$	60V	Maximum Junction Temperature	+125°C
Switch Collector to Emitter Voltage, $V_{CE(switch)}$	60V	Storage Temperature	-65°C to +150°C

ELECTRICAL CHARACTERISTICS

Electrical Characteristics at $V_{CC} = 5.0V$, $-40^{\circ}C \leq T_A \leq +85^{\circ}C$, unless otherwise noted.

PARAMETER	CONDITIONS	AMS36063			Units
		Min.	Typ.	Max.	
Oscillator					
Charging Current	$5.0V \leq V_{CC} \leq 60V$, $T_A = 25^{\circ}C$	20	35	50	μA
Discharge Current	$5.0V \leq V_{CC} \leq 60V$, $T_A = 25^{\circ}C$	150	200	250	μA
Voltage Swing	$T_A = 25^{\circ}C$		0.5		V_{P-P}
Discharge to Charge Current Ratio	$I_{PK(sense)} = V_{CC}$, $T_A = 25^{\circ}C$		6.0		-
Current Limit Sense Voltage	$I_{CHG} = I_{DISCHG}$, $T_A = 25^{\circ}C$	250	300	350	mV
Output Switch (Note 2)					
Saturation Voltage, Darlington Connection	$I_{SW} = 1.0A$, $V_{C(driver)} = V_{C(switch)}$		1.0	1.3	V
Saturation Voltage	$I_{SW} = 1.0A$, $I_{C(driver)} = 50mA$, (Forced $\beta \approx 20$)		0.45	0.7	V
DC Current Gain	$I_{SW} = 1.0A$, $V_{CE} = 5.0V$, $T_A = 25^{\circ}C$		35	120	
Collector Off-State Current	$V_{CE} = 60V$, $T_A = 25^{\circ}C$		10		nA
Comparator					
Threshold Voltage		1.18	1.25	1.32	V
Threshold Voltage Line Regulation	$3.0V \leq V_{CC} \leq 60V$		0.04	0.2	mV/V
Input Bias Current	$V_{IN} = 0V$		40	400	nA
Total Device					
ENABLE Low	$3.0V \leq V_{CC} \leq 60V$		2.15	1.90	V
ENABLE Low	$3.0V \leq V_{CC} \leq 60V$	2.50	2.26		V
Supply Current	$5.0V \leq V_{CC} \leq 60V$, $I_{PK(sense)} = V_{CC}$, $C_T = 0.001\mu F$, V pin 5 > V_{th} , Pin 2 = Gnd, Remaining pins open		2.4	4.0	mA

Note 1: Absolute Maximum Ratings are limits beyond which damage to the device may occur. For guaranteed performance limits and associated test conditions, see the Electrical Characteristics tables.

Note 2: To minimize power dissipation, low duty cycle pulse testing is used.

Note 3: Power dissipation at $T_A = 25^{\circ}C$ is equal to 1.0W for the 8 lead P DIP package and 625mW for the SO-8 package. For operation at temperatures above $T_A = 25^{\circ}C$ derate the power dissipation at 10mW/ $^{\circ}C$.

FUNCTIONAL BLOCK DIAGRAM

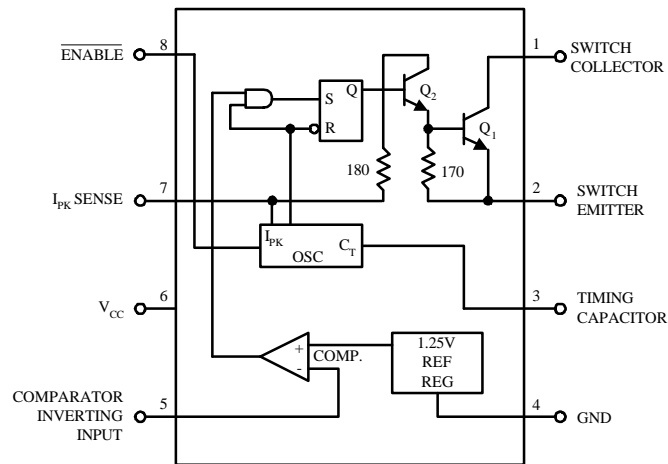

TYPICAL PERFORMANCE CHARACTERISTICS

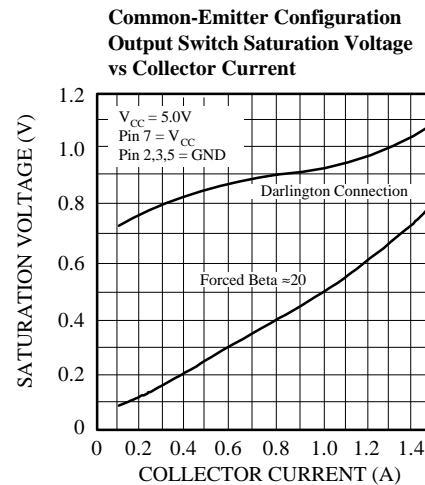
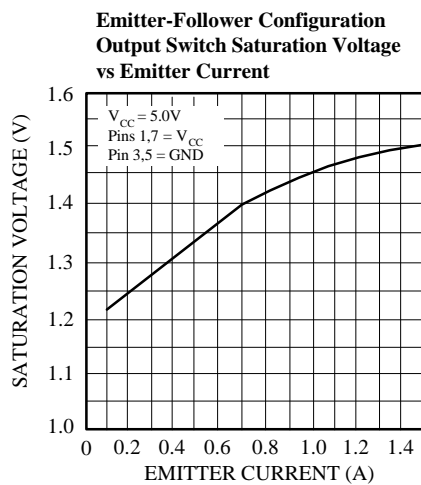
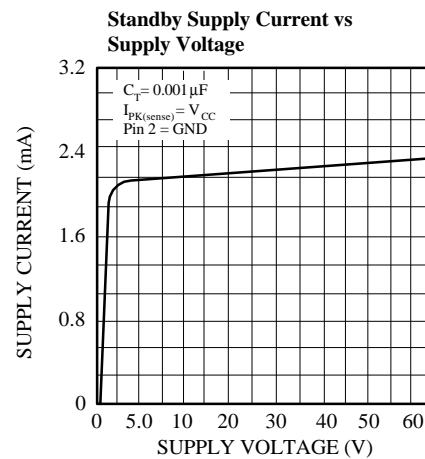
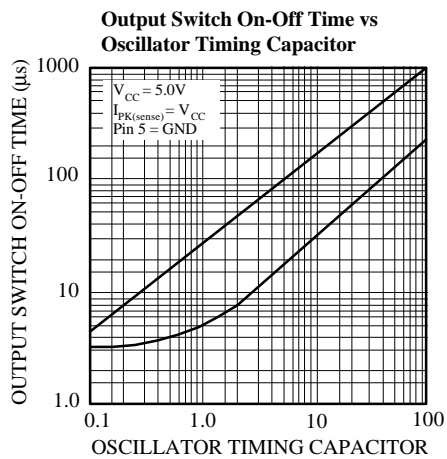

PACKAGE DIMENSIONS inches (millimeters) unless otherwise noted.

8 LEAD SOIC PLASTIC PACKAGE (S)

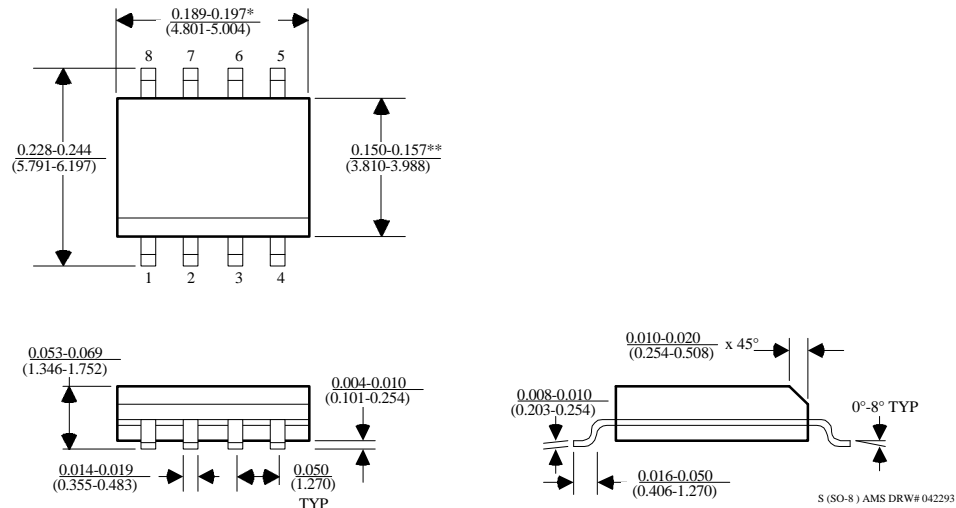

*DIMENSION DOES NOT INCLUDE MOLD FLASH. MOLD FLASH SHALL NOT EXCEED 0.006" (0.152mm) PER SIDE

**DIMENSION DOES NOT INCLUDE INTERLEAD FLASH. INTERLEAD FLASH SHALL NOT EXCEED 0.010" (0.254mm) PER SIDE

8 LEAD PLASTIC DIP PACKAGE (P)

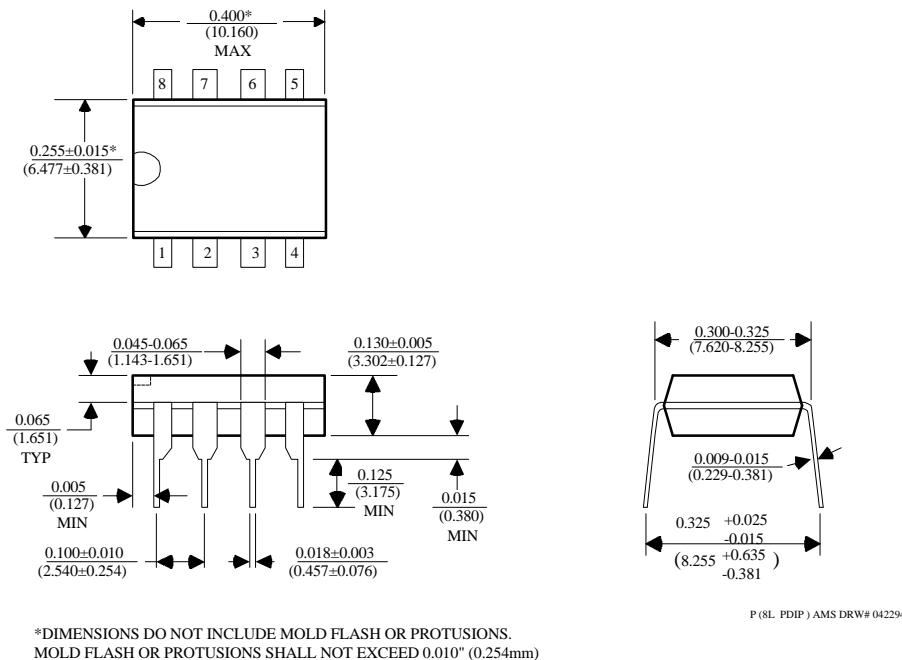

*DIMENSIONS DO NOT INCLUDE MOLD FLASH OR PROTUSIONS. MOLD FLASH OR PROTUSIONS SHALL NOT EXCEED 0.010" (0.254mm)