

FEATURES

- Fixed and Adjustable Versions Available
- Output Current in excess of 300mA
- Very Low Quiescent Current
- Reverse Battery Protection
- Input-output Differential less than 0.6V
- Short Circuit Protection
- Internal Thermal Overload Protection
- Load Dump Protection
- Overvoltage Protection
- Mirror Image Insertion Protection
- ON/OFF Pin
- External PNP Drive

APPLICATIONS

- Cellular Telephones
- Portable Consumer Equipment
- Portable (Notebook) Computers
- Battery Powered Systems
- Portable Instrumentation
- Radio Control Systems
- CD/DVD drives

GENERAL DESCRIPTION

The AMS3102 series consists of positive fixed and adjustable voltage regulators ideally suited for use in battery-powered systems. These devices feature very low quiescent current of 0.3mA or less when supplying 10mA loads. This unique characteristic and the extremely low input-output differential required for proper regulation (0.25V for output currents of 100mA) make the AMS3102 ideal to use for standby power systems.

Internal circuitry of AMS3102 is protected from input fault conditions caused by reverse battery installation or input voltages that exceed maximum rated input voltage. During line transients, such as load dump (40V) when the input voltage to the regulator can momentarily exceed the specified maximum operating voltage, the regulator will automatically shut down to protect both internal circuits and the load. The AMS3102 series also includes internal current limiting, thermal shutdown, and is able to withstand temporary power-up with mirror-image insertion.

The AMS3102 is offered in the 3-pin TO-92 package, SOT-89, 3 lead SOT-23, 5 lead SOT-23 and 8 lead SOIC packages. The device is provided with On/Off pin in SOT-23 5L and in 8 lead SOIC package.

ORDERING INFORMATION

OUTPUT VOLTAGE	PACKAGE TYPE					TEMP. RANGE
	TO-92	SOT-89	3L SOT-23	5L SOT-23	SO-8	
FIXED	AMS3102AN-X	AMS3102AL-X	AMS3102AM-X	AMS3102AM1-X	AMS3102AS-X	IND
	AMS3102N-X	AMS3102L-X	AMS3102M-X	AMS3102M1-X	AMS3102S-X	IND
		AMS3102ALR-X				
		AMS3102LR-X				
ADJ.				AMS3102CM1	AMS3102CS	IND

X = 2.0V, 2.5V, 3.0V, 3.3V, 3.5V, 4.0V, 5.0V.

R = Reverse pin-out option

ABSOLUTE MAXIMUM RATINGS (Note 1)

Input Voltage		Maximum Junction Temperature	+125°C
Operating	21V	Storage Temperature	-65°C to +150°C
Overvoltage Protection	24V to 40V	Lead Temperature (Soldering 25 sec)	265°C
Internal Power Dissipation (Note 4)	Internally Limited	ESD	2000V

ELECTRICAL CHARACTERISTICS

Electrical Characteristics at $V_{IN}=V_O+1V$, $I_O=10mA$, $T_J=25^\circ C$, $C_2=22\mu F$ unless otherwise specified.

PARAMETER	CONDITIONS	AMS3102A-X			AMS3102-X			Units
		Min.	Typ.	Max.	Min.	Typ.	Max.	
Fixed Output Voltage Versions								
Output Voltage Tolerance		-1.0		+1.0	-3.0		+3.0	%
	$(V_{IN}+1V) \leq V_{IN} \leq 21V$, $I_O=100mA$ $-40^\circ C \leq T_J \leq 125^\circ C$	-3.0		+3.0		± 5.0		%
Line Regulation	$(V_{IN}+1V) \leq V_{IN} \leq 15V$		5	10		5	10	mV
	$9V \leq V_{IN} \leq 21V$		8	30		8	30	mV
Load Regulation	$5mA \leq I_O \leq 100mA$		30	50		30	50	mV
	$5mA \leq I_O \leq 200mA$		50	70		50	70	mV
Dropout Voltage	$I_O = 100mA$		0.25	0.3		0.3	0.4	mV
	$I_O = 200mA$		0.5	0.6		0.5	0.6	mV
Quiescent Current	$I_O \leq 10mA$,		0.3	0.5		0.3	0.5	mA
	$I_O = 100mA$		3	4		3	4	mA
	$I_O \leq 200mA$ (Note 5)		9	12		9	12	mA
Output Noise Voltage	10Hz-100kHz, $C_{OUT} = 100\mu F$		500			500		μV rms
Output Impedance	100mA _{DC} and 10mA _{rms} , 100Hz=10kHz			200			200	m Ω
Ripple Rejection	$f_0 = 120Hz$	55	80			80		dB
Maximum Operational Input Voltage		21	22		21	22		V
Maximum Line Transient	$R_L = 500\Omega$, $V_O \leq 5.5V$ $T = 1ms$, $\tau \leq 100ms$	35	40		35	40		V
Reverse Polarity Input Voltage, D/C		-35	-40		-35	-40		V
Reverse Polarity Input Voltage, Transient	$R_L = 500\Omega$, $T = 1ms$, $\tau \leq 100ms$	-35	-40		-35	-40		V

ELECTRICAL CHARACTERISTICS

Electrical Characteristics at $V_{IN}=6V$, $V_{OUT}=3V$, $I_O=10mA$, $T_J=25^\circ C$, $R_1=27k$, $C_2=2\mu F$ unless otherwise specified.

PARAMETER	CONDITIONS (Note 2)	Min.	AMS3102C Typ.	Max.	Units
Adjustable Version					
Reference Voltage		1.210	1.235	1.26	V
	$I_O \leq 100\text{ mA}$, $-40^\circ C \leq T_J \leq 125^\circ C$, $R_1=27k$, Measured from V_{OUT} to Adjust Pin	1.20	1.235	1.270	V
Output Voltage Range		2		20	V
Line Regulation	$V_{OUT} + 1V \leq V_{IN} \leq 21V$.02	1.5	mV/V
Load Regulation	$5mA \leq I_O \leq 100\text{ mA}$		0.3	1	%
	$5mA \leq I_O \leq 200\text{ mA}$		1	2	%
Dropout Voltage	$I_O \leq 10\text{ mA}$		0.05	0.2	V
	$I_O = 100\text{ mA}$		0.3	0.4	V
	$I_O = 200\text{ mA}$ (Note 5)		0.5	0.6	V
Quiescent Current	$I_O = 10\text{ mA}$		0.3	0.5	mA
	$I_O = 100\text{ mA}$		3	4	mA
	During Shutdown $R_L = 500\Omega$		0.3	0.5	mA
Output Noise Voltage	10Hz-100kHz		100		$\mu V_{rms}/V$
Output Impedance	$100mA_{DC}$ and $10mA_{rms}$, 100Hz=10kHz		40	200	$m\Omega$
Long Term Stability	$T = 1000hr$		0.4		%/1000hr
Ripple Rejection	$f_o = 120Hz$		0.02		dB
Maximum Operational Input Voltage		21	22		V
Maximum Line Transient	$I_O = 10mA$, Reference Voltage $\leq 1.5V$ $T = 1ms$, $\tau \leq 100ms$	35	40		V
Reverse Polarity Input Voltage, D/C	$R_L = 500\Omega$, $V_O \geq -0.3V$	-35	-40		V
Reverse Polarity Input Voltage, Transient	$R_L = 500\Omega$, $T = 1ms$, $\tau \leq 100ms$	-35	-40		V
On/Off Threshold Voltage	$V_O = 3V$				
		On		1.8	1.5
Off		2.5	2.0		V
On/Off Threshold Current	$V_{OFF} = 2.4V$		35	60	μA

Note 1: Absolute Maximum Ratings are limits beyond which damage to the device may occur. For guaranteed performance limits and associated test conditions, see the Electrical Characteristics tables.

Note 2: To ensure constant junction temperature, low duty cycle pulse testing is used.

Note 3: Limits appearing in **boldface** type apply over the entire junction temperature range for operation. Limits appearing in normal type apply for $T_A = T_J = 25^\circ C$.

Note 4: The maximum allowable power dissipation is a function of the maximum junction temperature $T_J(MAX)$, the junction-to ambient thermal resistance θ_{JA} and the ambient temperature T_A . The maximum allowable power dissipation at any ambient temperature is calculated using:

$$P(MAX) = \frac{T_J(MAX) - T_A}{\theta_{JA}}$$

Where the value of the junction-to-ambient thermal resistance are as follows: $195^\circ C/W$ for the TO-92 (N) package, $110^\circ C/W$ for SOT-89 (L), $220^\circ C/W$ for 5 lead SOT-23 (M1) and $160^\circ C/W$ for the molded plastic SO-8 (S).

Note 5: Dropout Voltage is defined as the input to output differential at which the output voltage drops 100mV below its nominal value measured at 1V differential.

PIN CONNECTIONS

**TO-92
Plastic Package (N)**

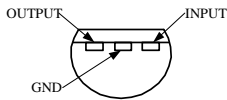

Bottom View

**SOT-89
(L)**

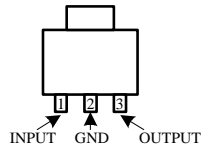

Top View

**SOT-89
(L)
R = Reverse pin-out**

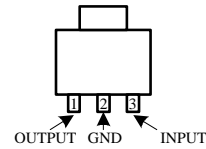

Top View

**3 Lead SOT-23
(M)**

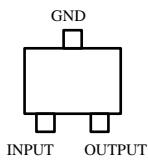

Top View

**5 Lead SOT-23
(M1)**

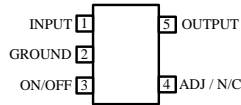

Top View

**8L SOIC
SO-Package (S)**

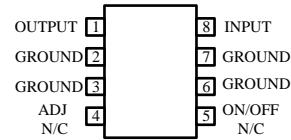

Top View

TYPICAL PERFORMANCE CHARACTERISTICS

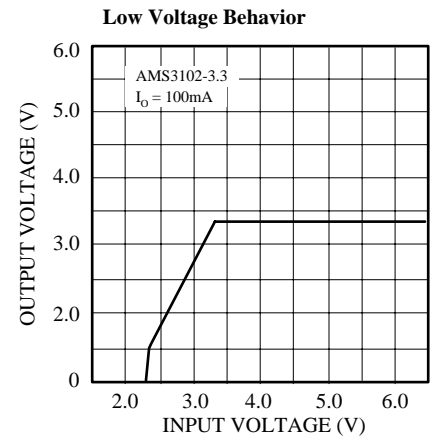
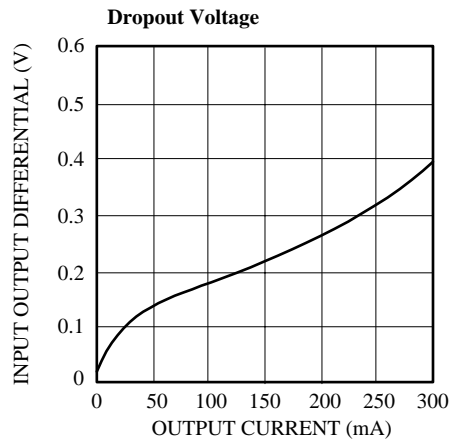
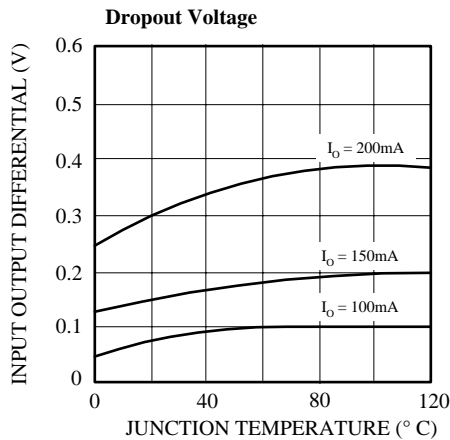

TYPICAL PERFORMANCE CHARACTERISTICS (Continued)

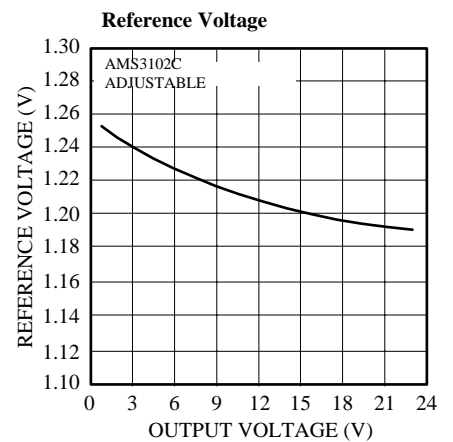
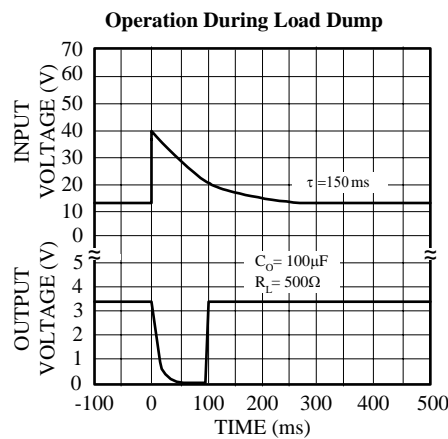
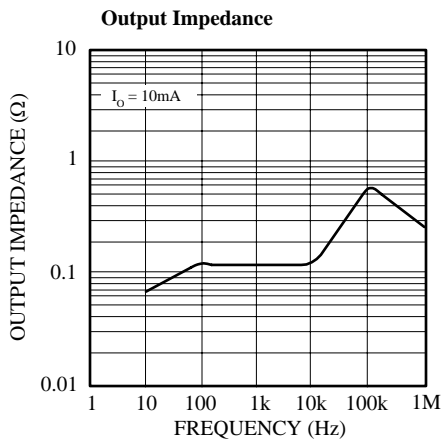
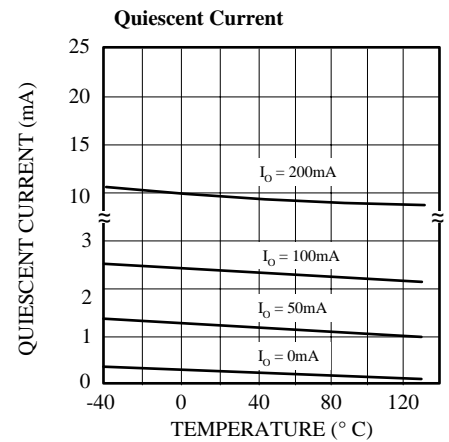
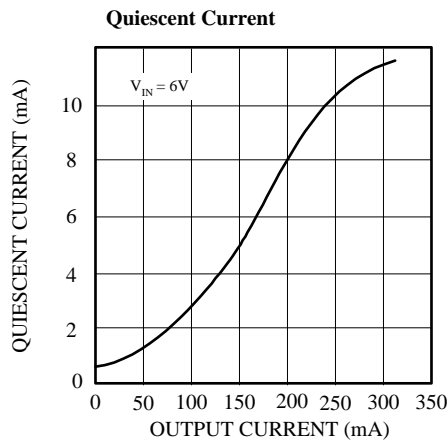
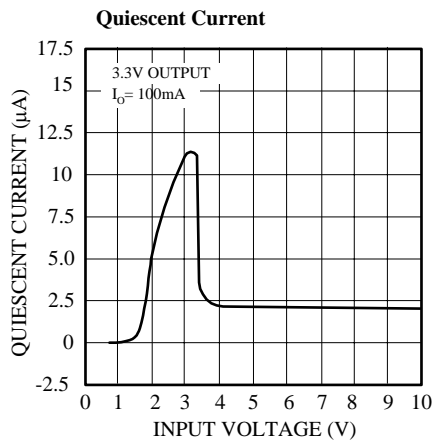
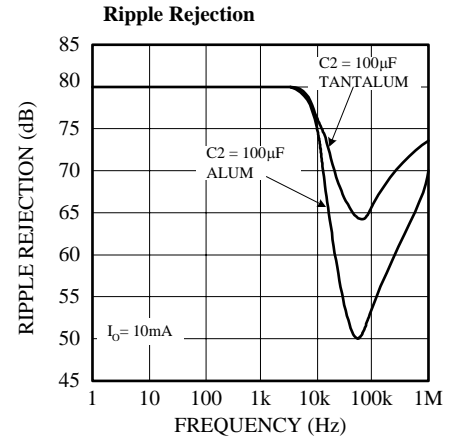
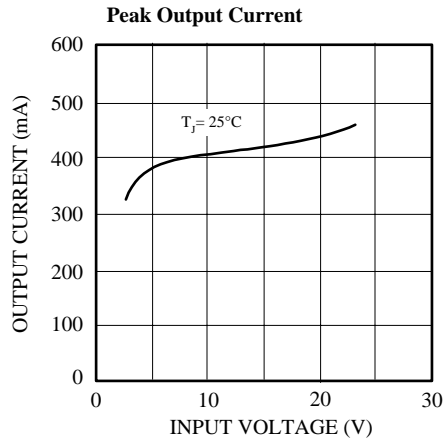
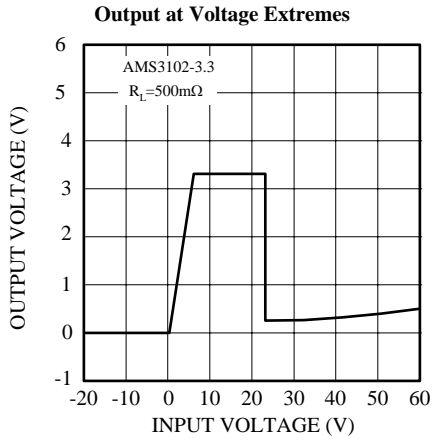

APPLICATION NOTES

Definition of Terms

Dropout Voltage: The input-output voltage differential at which the circuit stops to regulate against further reduction in input voltage. Measured when the output voltage has dropped 100mV from the nominal voltage obtained at 1V input, dropout voltage is dependent upon load current and junction temperature.

Input Voltage: The DC voltage applied to the input terminal with respect to ground.

Input-Output Differential: The voltage difference between the unregulated input voltage and the regulated output voltage for which the regulator will regulate.

Line Regulation: The change in output voltage for a change in the input voltage. The line regulation is measured under conditions of low dissipation or by using low duty cycle pulse testing such that the average chip temperature is not significantly affected.

Load Regulation: The change in output voltage for a change in load current at constant chip temperature.

Long term stability: Output voltage stability under accelerated life-test conditions after 1000 hours with maximum rated voltage and junction temperature.

Output Noise Voltage: The rms AC voltage at the output, with constant load and no input ripple, measured over a specified frequency range.

Quiescent Current: That part of the positive input current that does not contribute to the positive load current. The regulator ground lead current.

Ripple Rejection: The ratio of the peak-to-peak input ripple voltage to the peak-to-peak output ripple voltage at specified frequency.

Temperature Stability of V_O : The percentage change in output voltage for a thermal variation from room temperature to either temperature extreme.

External capacitor

The AMS3102 series require an output capacitor of 2.2 μ F or greater to ensure device stability. Without the capacitor the device may oscillate.

Most type of tantalum or electrolytic capacitor can be used in the applications. A critical characteristic of the capacitors is an ESR value of 5 Ω or less and a resonant frequency above 500kHz. The value of this capacitor can be increased without limits.

For higher loads, the value of the capacitor should be increased, specially when the output voltage is set for 2.5V or less. The AMS3102 lowest fixed output voltage value is 2.0V.

Typical application circuit (adjustable output)

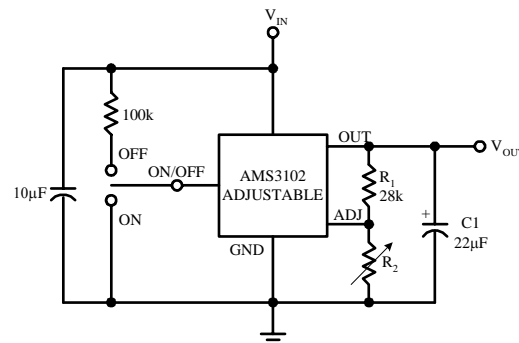

Minimum Load

In circuits using the fixed output voltage versions, minimum load is not required. For circuits using the adjustable device, the value of R1 and R2 should be chosen such, that a current of approximately 40 μ A flows through the network. The reference voltage (1.235V) is measured between the adjust pin and V_{OUT} . The output voltage can be set by the two resistors R1 and R2 using the following equation:

$$V_O = V_{REF} \left(\frac{R_1 + R_2}{R_1} \right)$$

The value of R1 is recommended to be between 25k Ω to 30 k Ω , and the value of R2 will set the output voltage.

PACKAGE DIMENSIONS inches (millimeters) unless otherwise noted.

3L TO-92 PLASTIC PACKAGE (N)

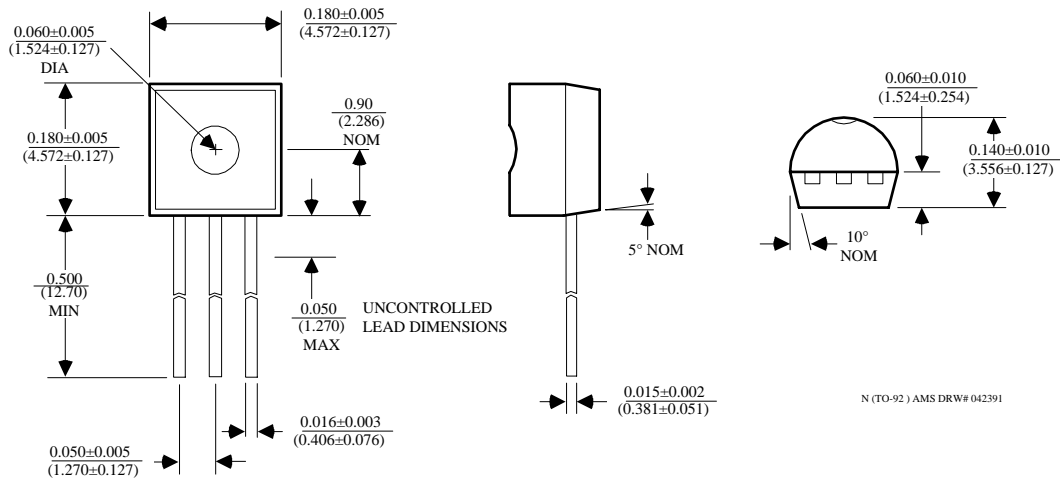

5 LEAD SOT-23 PLASTIC PACKAGE (M1)

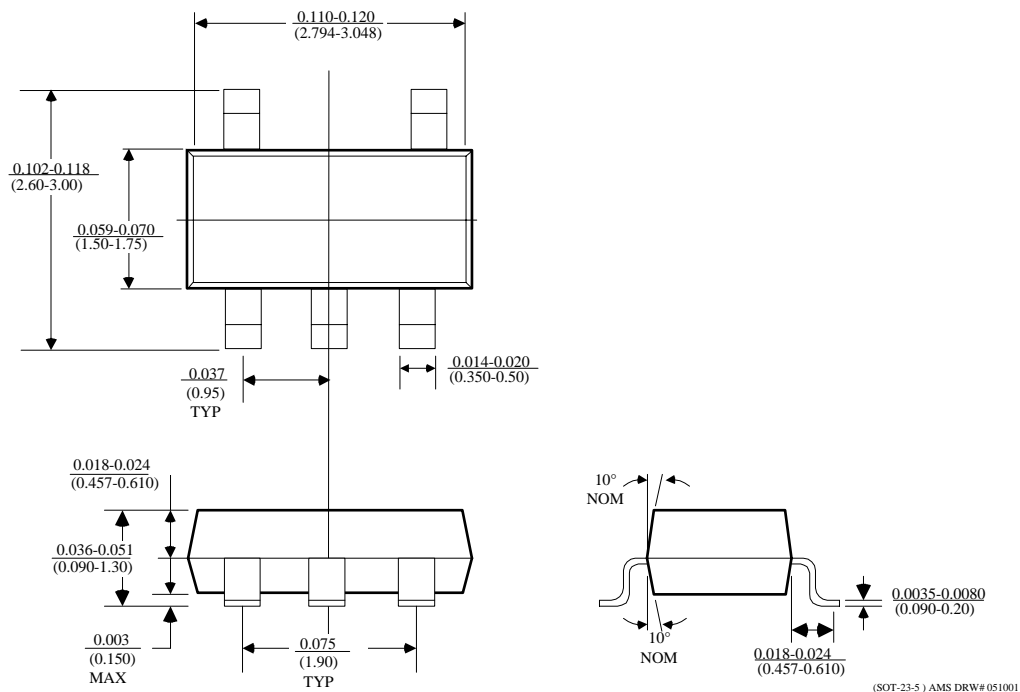

PACKAGE DIMENSIONS inches (millimeters) unless otherwise noted (Continued).

SOT-89 PLASTIC PACKAGE (L)

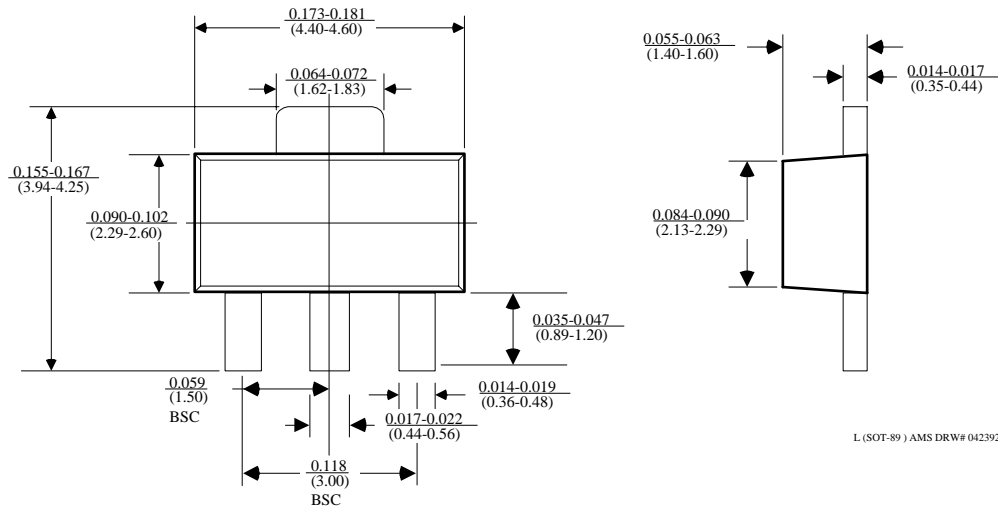

8 LEAD SOIC PLASTIC PACKAGE (S)

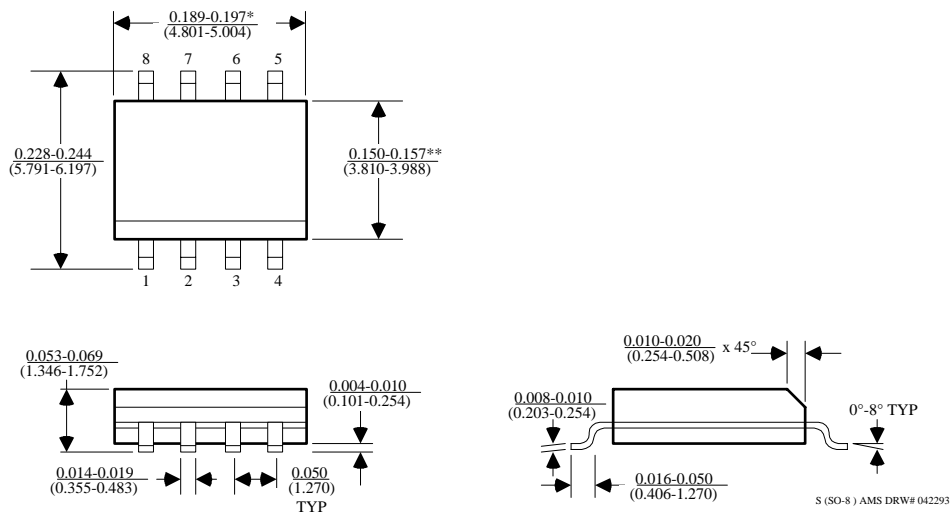

*DIMENSION DOES NOT INCLUDE MOLD FLASH. MOLD FLASH SHALL NOT EXCEED 0.006" (0.152mm) PER SIDE

**DIMENSION DOES NOT INCLUDE INTERLEAD FLASH. INTERLEAD FLASH SHALL NOT EXCEED 0.010" (0.254mm) PER SIDE