

# M51722P,FP

## F-V CONVERTER WITH MULTIPLEXER

80C 08982 DT-73-13-03

6249826 MITSUBISHI ELEK (LINEAR)

### DESCRIPTION

The M51722P,FP are semiconductor integrated circuits developed for frequency-voltage (F-V) converter.

In combination with predriver ICs, the devices constitute high-accuracy 2-phase, 3-phase, F-servo motor control system.

### FEATURES

- Built-in frequency multiplexer controls motors with high accuracy.
- Operates at a low supply voltage (supply voltage range 4.5~10V)
- Built-in FG amplifier circuit enables operation by weak signals
- Large final stage output current (current source and current sink)

### APPLICATION

VTRs, floppy-disk drive, etc.

### RECOMMENDED OPERATING CONDITIONS

Supply voltage range ..... 4.5~10V  
 Rated supply voltage ..... 9V

### PIN CONFIGURATION (TOP VIEW)

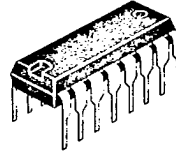
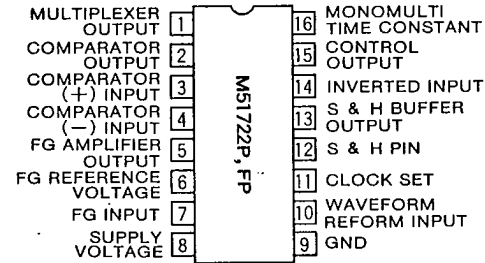

16-pin molded plastic DIP



16-pin molded plastic FLAT (C type)

### BLOCK DIAGRAM

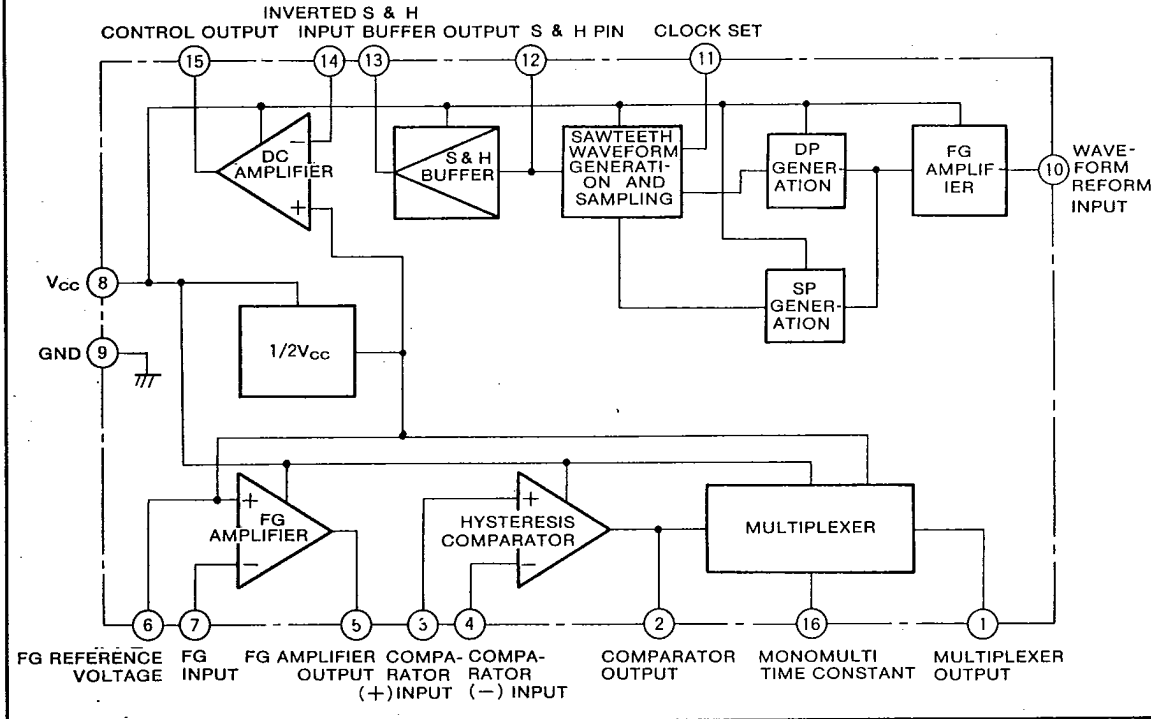

**ABSOLUTE MAXIMUM RATINGS** ( $T_a=25^{\circ}\text{C}$ , unless otherwise noted)

Symbol	Parameter	Conditions	Rated	Unit
$V_{CC}$	Supply voltage		10	V
$I_{O2}$	Pin ② output current		8	mA
$I_{O5}$	Pin ⑤ output current		2	mA
$I_{O1}$	Pin ① source current		8	mA
$I_{O5}$	Pin ⑤ sink current		12	mA
$I_{O13}$	Pin ⑬ output current		1	mA
$V_{O7}$	Pin ⑦ input voltage		$1.5 \sim V_{CC}$	V
$V_{O10}$	Pin ⑩ input voltage		$0 \sim V_{CC}$	V
$P_{DF}$	Power dissipation		770(430)	mW
$K_{\theta}$	Thermal derating		7.7(4.3)	mW/°C
$T_{opr}$	Operating temperature		$-20 \sim +75$	°C
$T_{stg}$	Storage temperature		$-40 \sim +125$	°C

Note: ( ) = M51722FP

**ELECTRICAL CHARACTERISTICS** ( $T_a=25^{\circ}\text{C}$ ,  $V_{CC}=9\text{V}$ , unless otherwise noted)

Symbol	Parameter	Test conditions	Limits			Unit
			Min	Typ	Max	
$I_{CC(1)}$	Circuit current (1)	$V_{CC}=4.5\text{V}$		4.5	9	mA
$I_{CC(2)}$	Circuit current (2)	$V_{CC}=10\text{V}$		4.5	9	mA
$V_{ref(1)}$	Reference voltage of output voltage (1)	Pin ⑥ Open	4.4	4.5	4.6	V
$V_{ref(2)}$	Reference voltage of output voltage (2)	10k $\Omega$ between pin ⑥ and GND	4.4	4.5	4.6	V
$V_{OH5}$	Pin ⑤ high-level output	3.9k $\Omega$ between pin ⑤ and GND	6.0	6.8		V
$V_{OL5}$	Pin ⑤ low-level output	3.9k $\Omega$ between $V_{CC}$ and pin ⑤		1.0	1.5	V
$V_{OH2}$	Pin ② high-level output	2k $\Omega$ between pin ② and GND	7.5	8.0		V
$V_{OL2}$	Pin ② low-level output	2k $\Omega$ between $V_{CC}$ and pin ②		1.0	1.5	V
$V_{OH13}$	Pin ⑬ high-level output	1.5k $\Omega$ between pin ⑬ and GND	6.6	7.5		V
$V_{OL13}$	Pin ⑬ low-level output	1.5k $\Omega$ between $V_{CC}$ and pin ⑬		1.0	1.5	V
$V_{offset6-7}$	Pin ⑥ - pin ⑦ offset voltage				$\pm 6$	mV
$V_{offset3-4}$	Pin ③ - pin ④ offset voltage				$\pm 6$	mV
$V_{offset12-13}$	Pin ⑫ - pin ⑬ offset voltage				$\pm 6$	mV
$T_{O1}$	Pin ① pulse width	Pin ⑬ time constant 100k $\Omega$ + 820pF	45	55	65	$\mu\text{s}$

**M51722P,FP**

**F-V CONVERTER WITH MULTIPLEXER**

6249826 MITSUBISHI ELEK (LINEAR)

80C 08984

D T-73-13-03

**THERMAL DERATING (MAXIMUM RATING)** ( $T_a=25^\circ\text{C}$ , unless otherwise noted)

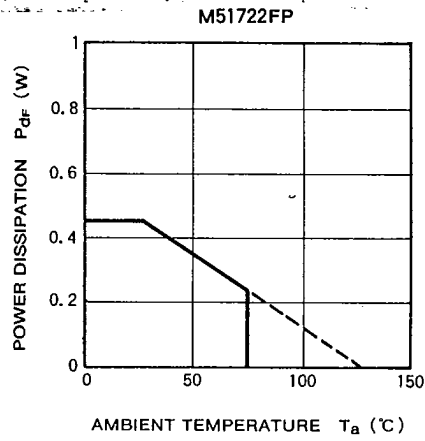
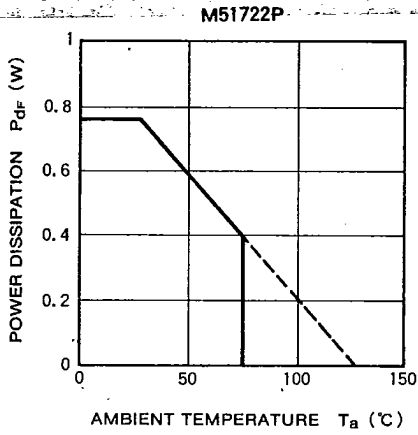

**APPLICATION EXAMPLE**

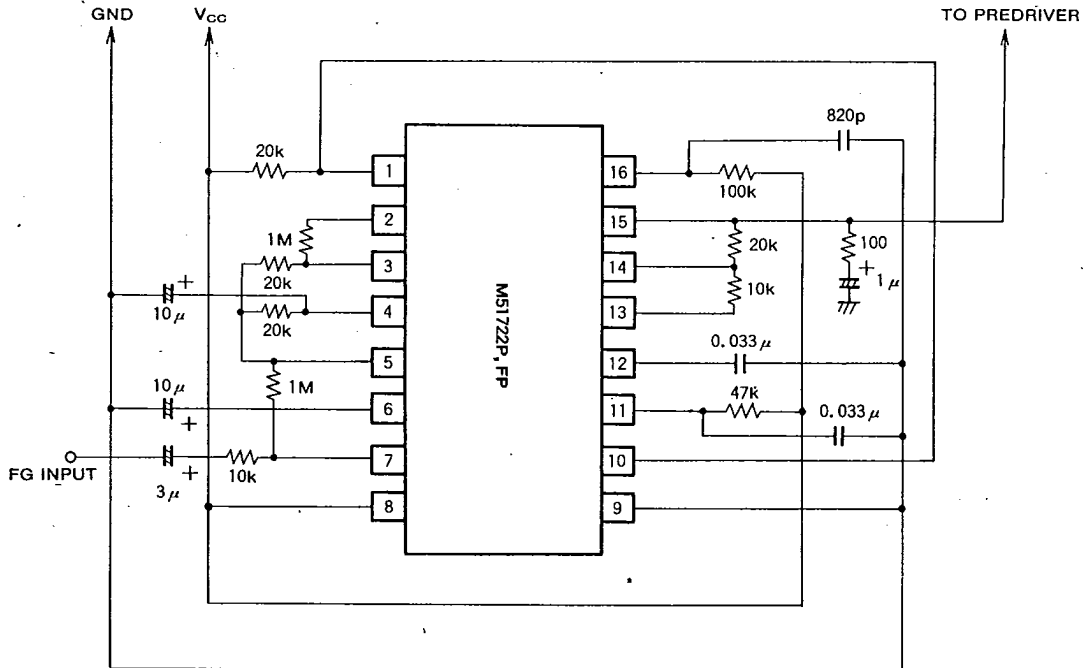

Unit Resistance :  $\Omega$   
Capacitance : F

**F-V CONVERTER WITH MULTIPLEXER**

6249826 MITSUBISHI ELEK (LINEAR)

80C 08985

D7-73-13-03

**TYPICAL CHARACTERISTICS** ( $T_a=25^\circ\text{C}$ , unless otherwise noted)

**CIRCUIT CURRENT VS. SUPPLY VOLTAGE**

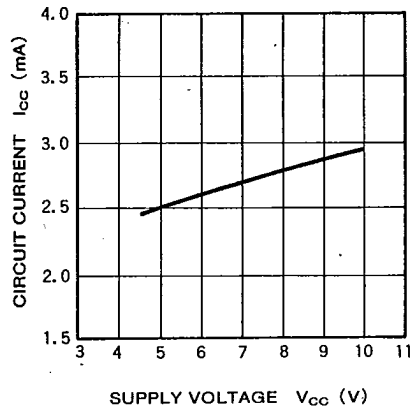

**REFERENCE VOLTAGE VS. SUPPLY VOLTAGE**

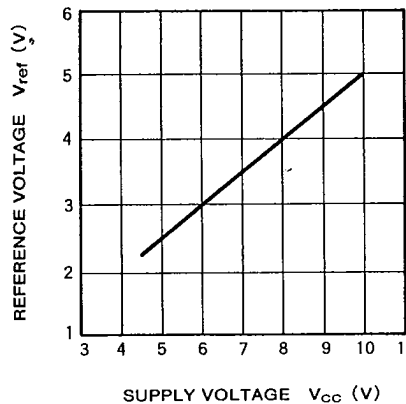

**PIN ② SOURCE CURRENT VS. SUPPLY VOLTAGE**

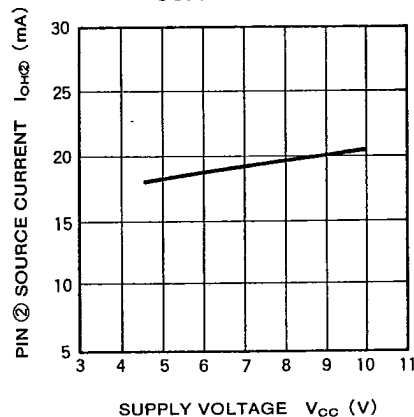

**PIN ⑤ SOURCE CURRENT VS. SUPPLY VOLTAGE**

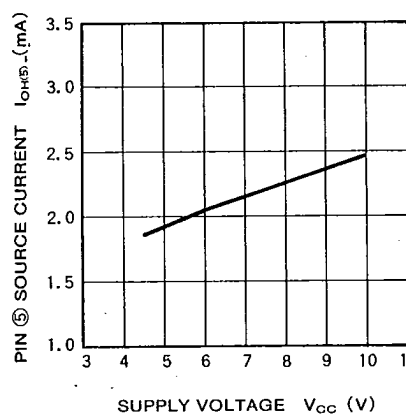

**PIN ⑬ SOURCE CURRENT VS. SUPPLY VOLTAGE**

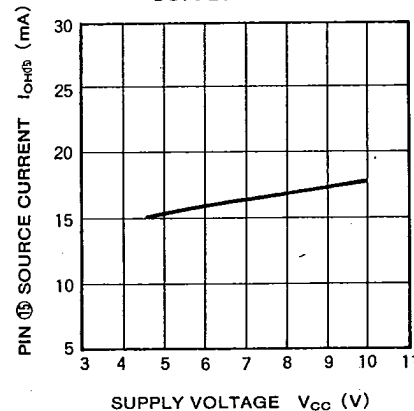

**F-V CONVERTER WITH MULTIPLEXER**

6249826 MITSUBISHI ELEK (LINEAR)

80C 08986 D 7-73-13-03

**CIRCUIT CURRENT VS. AMBIENT TEMPERATURE**

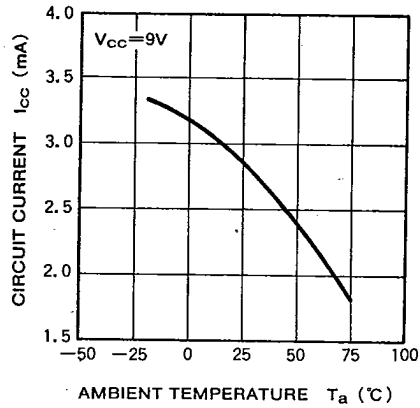

**PIN ② SOURCE CURRENT VS. AMBIENT TEMPERATURE**

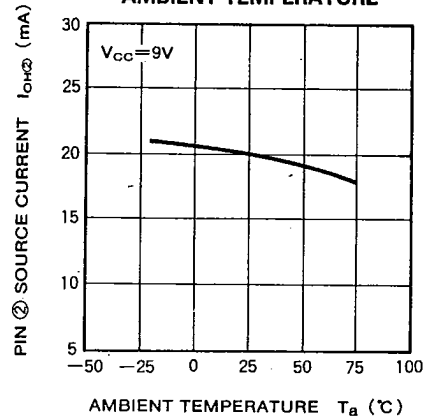

**PIN ⑤ SOURCE CURRENT VS. AMBIENT TEMPERATURE**

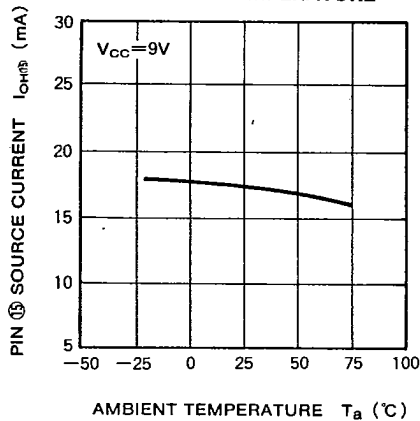

**REFERENCE VOLTAGE VS. AMBIENT TEMPERATURE**

