



GENERAL DESCRIPTION

The EM91203 is a series of tone/pulse switchable dialers that is composed of T/P dialer and T/P dialer with 3 sets memories. The EM91203 series provides necessary functions of telephone set for application in any environment, such as Pulse dialing, Tone (DTMF) dialing, Handfree dialing, keying tone , mute and pulse mute functions. Beside this, SDO (Serial Data Output) functions is provided in advance version that is designed to drive LCD driver and voice synthesizer. In this application, the dialing numbers can be displayed on LCD screen with EM32100 (or EM32116).

FEATURES

- Tone/Pulse switchable.
- Wide operating voltage from 2.0 V to 5.5 V.
- Low operating current, 0.15 mA (Pulse) and 0.3 mA (Tone) typically.
- Adding resistor on keyboard scan pin that can select many telephone specifications, such as : Pulse rate, M/B ratio, Flash time, Pause time, P-T wait time and keyboard type.
- SDO function supports LCD driver and voice synthesizer to indicate dialing numbers.
- Handfree function provides on-hook dialing and speakerphone application.
- 3-set one touch repertory memory, each one can store data up to 16 digits.
- A 32-digit LNB (last number) redial memory.
- A 32-digit SAVE redial memory.
- Keytone function provides rapidly keying recognition.
- Pulse mute function supports pulse dialing application.
- Using 3.579545 MHz crystal or ceramic resonator.
- Package forms: PDIP, skinny.

ORDERING INFORMATION

Versions list

VERSION	LNB	KT	SAVE	HF	SDO(LCD)	PMUTE
EM91203A	√	√	√			√
EM91203B	√	√	√	√		√
EM91203C	√	√	√	√	√	√

EM91203

Pin Assignment

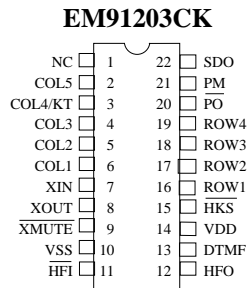
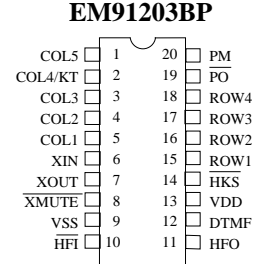
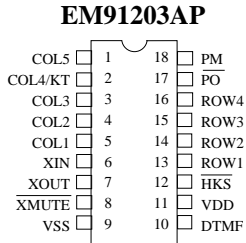

Keyboard Arrangement

Type A

	COL1	COL2	COL3	COL4/KT	COL5
ROW1	1	2	3	SAVE	EM1
ROW2	4	5	6	F	EM2
ROW3	7	8	9		EM3
ROW4	*/T	0	#	RD/P	ST

Type B

	COL1	COL2	COL3	COL4/KT	COL5
ROW1	1	2	3	SAVE	EM1
ROW2	4	5	6	F	EM2
ROW3	7	8	9	P→T	EM3
ROW4	*	0	#	RD/P	ST

FUNCTIONAL BLOCK DIAGRAM

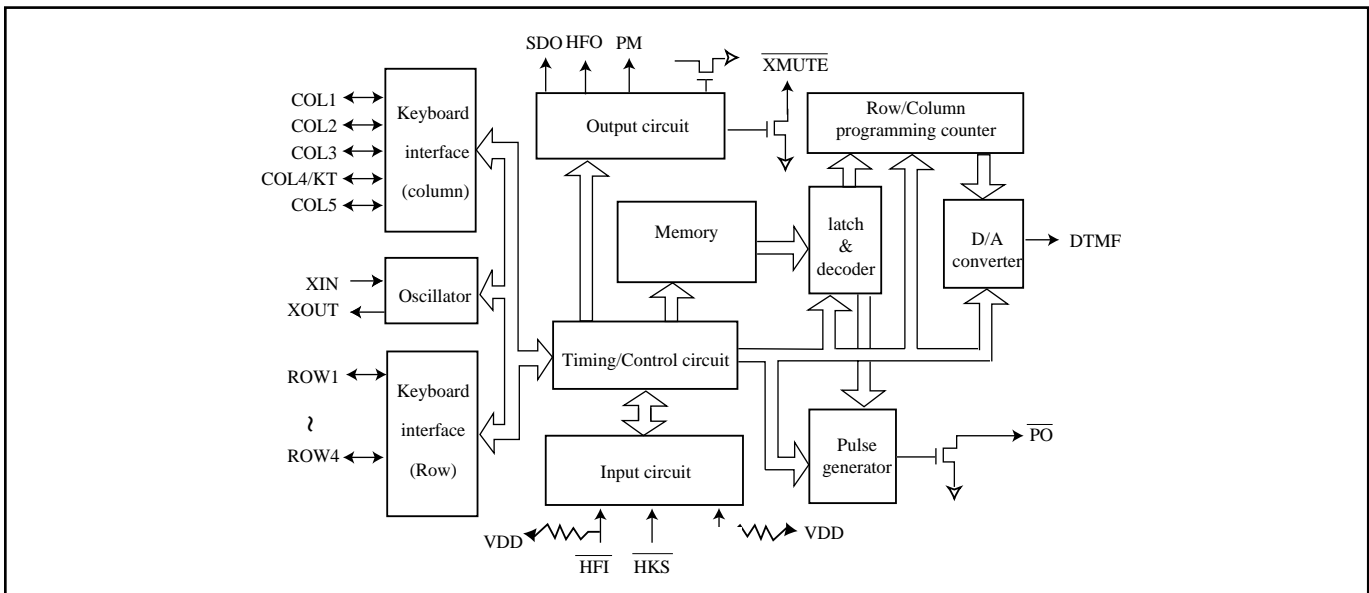

* This specification are subject to be changed without notice.

PIN DESCRIPTIONS

Symbol	Function
ROW1~ROW4	Keyboard scan pins of row group. In idle state ($\overline{\text{HKS}}$ is “High” and HFO is “Low”), these pins stay “High impedance” level to prevent power consumption. Otherwise, these pins switch to “High” level for detecting keyboard entry. These pins will output 600 Hz signal while keyboard is scanning.
COL1~COL3 and COL5	Keyboard scan pins of column group. In idle state, these pins stay “High impedance” level. Otherwise these pins switch to “Low” level for detecting keyboard entry. These pins will output 600 Hz signal while keyboard is scanning.
COL4/KT	The fourth column group pin of the keyboard that also provides the keytone output. Normally, this pin stays “Low” level for detecting keyboard entry. After a valid keyboard entry, this pin will output keying confirmation tone that is 600 Hz signal and 30 ms duration. While DTMF output, the key tone will be disabled. To prevent signal interference, while DTMF issue, it will disable key tone output except function key.
XIN and XOUT	Oscillator input and output pins. A 3.579545 MHz crystal or ceramic resonator must be crossed connection to XIN and XOUT pins which generate system clock.
$\overline{\text{XMUTE}}$	The Tone/Pulse MUTE signal output pin that is NMOS open-drain output structure. This pin will switch to “Low” level during Tone/Pulse dialing. Otherwise, this pin stays “High impedance” level.
V_{DD} and V_{SS}	Positive and negative power supply input pins. Recommended operating voltage from 2.0Vdc to 5.5Vdc.
HFI	Handfree inputs pin which accepts falling edge signal to turn “on” or turn “off” handfree function. This pin is hysteresis input structure and built-in pull up resistor (typically 200 Kohms).
HFO	Handfree outputs pin that is designed to control telephone line for on-hook dialing or control speakerphone circuit for handfree conversation. When handfree function is executed, this pin will switch to “High”. Otherwise, this pin stays “Low” level.
DTMF	The DTMF (Dual Tone Multi-Frequency) output pin. Normally, this pin stays “Low” level. In Tone dialing mode, this pin will output DTMF signal that is corresponding to keyboard 0..9, * and # keys.
HKS	Control signal inputs pin that is corresponding hook switch status. When handset was left from cradle, this pin must be connected to “Low” level to operate all functions. Otherwise, this pin must be connected to “High” level to disable all function and prevent power consumption.
$\overline{\text{PO}}$	Pulse signal outputs pin that is NMOS open-drain output structure. Normally, this pin stays “High impedance” level. In Pulse dialing mode and keypad was entry. This pin will output pulse trains signal that is corresponding to keyboard 0 .. 9 keys.
PM	Pulse signal outputs pin that is CMOS inverter output structure. Normally, this pin stays “Low” level. During pulse signal dialing or flash function executing, this pin will switch to “High” level to control the external circuit.
SDO	SDO function output that is NMOS open-drain structure. When there is a valid entry on keyboard, this pin will output a serial data. This serial data is designed to drive LCD driver to display dialing number on LCD screen or drive voice synthesizer to announce dialing number to speaker.
NC	No connection.

FUNCTION DESCRIPTIONS

Dialing signal selection

The EM91200s series incorporated a special keyboard scanning function that is connecting a resistor (typically is 560 Kohms) on keyboard scan pin to select many telephone specifications. The specifications are described as following :

a. Mode

ROW1	Mode
R-Vdd	20 PPS
NR	Tone
R-Vss	10 PPS

b. M/B ratio

ROW2	MBR (%)
NR	40:60
R-Vss	33:66

c. Flash time

ROW3	ROW4	Tf (ms)
NR	NR	600
NR	R-Vss	100
R-Vss	NR	80
R-Vss	R-Vss	300

d. DTMF signal

COL1	Td (ms)	Titp (ms)
R-Vdd	90	90
NR	98	98
R-Vss	83	83

e. Pause time and P-T wait time

COL2	Tp (sec)	Tpt (ms)
NR	3.6	3.6
R-Vss	2.0	2.0

f. Keyboard operate type

COL3	Type
NR	A
R-Vss	B

Normal dialing

Directly keying digital key on keyboard which number can be dialing output and stored in LNB memory automatically. Operating procedure described as follow :

- To select Pulse or Tone mode.
- Off-hook or turn on HF function.
- Keying d1, d2, .. , dn. The “d” expressed digital keypad that included 1~9, *, 0, #, P, and P→T keys. The “n” expressed unlimited.
- The numbers d1, d2, .. , dn will be dialed out in Pulse or Tone mode as selection.

LNB redial memory

Storing:

In normal dialing mode, every digital key was entry which number will be stored in LNB memory automatically. If entry digits are more than 32 digits, the redial function of LNB memory will be disabled. Otherwise, these numbers stored in LNB memory can be redial output.

Redialing:

After normal dialing, directly keying F key (or On-Off hook once) and keying RD key on keyboard. The numbers that are stored into LNB memory will be dialed output.

SAVE redial memory

The SAVE meomry is designed in EM91203 series to support 32 digits capacity buffer for second redial, pager, Memory and other system applications.

Storing : EM91203 series support two operating methods to store numbers into SAVE redial memory.

Method 1

- To select Pulse or Tone mode.
- Off-hook (or turn on HF function), push d1, d2, .. , dn. The numbers d1, d2, .. , dn will be dialed out in Pulse or Tone mode as selection.
- After dn had been dialed out and push [ST], Save key. If the keying numbers are more than 32 digits that content of SAVE memory can not be updated. Otherwise, these numbers will be stored into SAVE memory. In the [] key allows to be omitted.

Method 2

Off-hook (or turn on HF function), push ST, d1, d2, .. , dn, [ST], Save. If the keying numbers are not over 32 digits, the numbers d1, d2, .. , dn will be stored in SAVE redial memory automatically.

Dialing :

- To select Pulse or Tone mode.
- Off-hook (or turn on HF function), push Save key. The numbers stored in SAVE memory will be dialed out in Pulse or Tone mode as selection.

Repertory memory

The EM91203 series incorporated several sets repertory memory and each one can store number up to 16 digits. As in memory storing, if stored numbers are more than 16 digits that only the previous 16 digits can be stored into specific memory. Otherwise, these numbers can be stored entirely. After memory dialed out, the content of LNB is keeping to current data.

Storing of 3 sets memory

Direct (one-touch) operation

Off-hook (or turn on HF function), push ST, d1, d2, .. , dn [ST], EMn. The numbers d1, d2, .. , dn will be stored into memory location “EMn”. The “EMn” expressed emergency memory EM1 to EM3.

Dialing (after memory dialed out, the content of LNB is keeping to current data)

Direct (one-touch) memory operation

- To select Pulse or Tone mode.
- Off-hook (or Turn on HF function), push EMn key. The numbers that are stored in direct memory location EMn will be dialed out in Pulse or Tone mode as selection. The “n” expressed digital number from 1~3 decided by dialers’ memory sets.

Pause (P) key operation

The Pause (P) key is designed to support pause operation in dialing duration. “P” key can be stored in memory and it will occupy one digital position.

- To select Pulse or Tone mode.
- Off-hook (or turn on HF function), push **d1, d2, .. , dn, RD/P, k1, k2, .. , kn** . These numbers will be dialed out as following sequence:

d1, d2, .. , dn, Tp, k1, k2, .. , kn.

Pulse to Tone (*T or P-T) key operation

The Pulse to Tone (*T or P-T) key is designed to support toll dialing (long distance call) or PABX system operation. The "*T (or P-T)" key can be stored in memory and it will occupy one digital position.

- To select Pulse mode.
- Off-hook (or turn on HF function), push **d1, d2, .. , dn, *T, (or P-T) k1, k2, .. , kn**. These numbers will be dialed out as following sequence:

d1, d2, .. , dn, Tpt, k1, k2, .. , kn.
(pulse mode) (tone mode)

Flash (F) key operation

The Flash (F) key is designed to break telephone line temporarily. After F key is depressed, this dialer will send a flash signal to break line 600 ms, 300 ms, 100 ms or 80 ms as ROW3 and ROW4 selection.

Handfree (HF) function

The handfree function is designed to support on-hook dialing and loudspeaker application which can be turn “on” or “off” with falling edge signal from $\overline{\text{HFI}}$ pin. During handfree function is executed, the HFO pin is switched to “high”. Otherwise the HFO pin stays “low” level.

Truth table

Operating state	Input/Output pin level				
	HKS	PO	$\overline{\text{XMUTE}}$	PM	HFO
(0) On-hook, idle state	H	F	F	L	L
(1) Off-hook line	L	F	F	L	L
(2) Off-hook, HF line	L	F	F	L	H
(3) On-hook, HF line	H	F	F	L	H

Note : F=floating (high impedance); H=logic “High”; L=logic “Low” level.

SDO (Serial Data Output) function

The SDO is serial data output which format is same as UART protocol. SDO function is designed to drive LCD driver and voice synthesizer. So the dialing numbers can be display on LCD screen with EM32100 (or EM32116). The SDO signal consists of two start bits, six data bits and two stop bits. Each bit time is about 3.9 ms (256 Hz) and output sequences are following by start bits, data bits (LSB to MSB) and stop bits.



SDO Keypad Encoded table:

◆ Digital key (b5,b4=0,0)

keypad	1	2	3	4	5	6	7	8	9	0	“*/T	#	P	*/T” or P-T
output b3,b2,b1,b0	0001	0010	0011	0100	0101	0110	0111	1000	1001	1010	1011	1100	1101	1110
Display	1	2	3	4	5	6	7	8	9	0	L	J	P	—

◆ Function key (b5,b4=1,0)

keypad	F
output b3,b2,b1,b0	1111
Display	clear all display

* Keypad,SDO format and LCD display reference table:

Keypad	bit5	bit4	bit3	bit2	bit1	bit0	Display
1	0	0	0	0	0	1	1
2	0	0	0	0	1	0	2
3	0	0	0	0	1	1	3
4	0	0	0	1	0	0	4
5	0	0	0	1	0	1	5
6	0	0	0	1	1	0	6
7	0	0	0	1	1	1	7
8	0	0	1	0	0	0	8
9	0	0	1	0	0	1	9
0	0	0	1	0	1	0	0
“*/T	0	0	1	0	1	1	L
#	0	0	1	1	0	0	J
P	0	0	1	1	0	1	P
*/T” or P-T	0	0	1	1	1	0	—
F	1	0	1	1	1	1	clear all display

ABSOLUTE MAXIMUM RATINGS(Ambient temperature is 25 °C, all voltages referenced to V_{SS})

Items	Sym.	Rating	Unit
Power supply voltage	V_{DD}	6.0 Vdc	V
Input voltage range	V_{IN}	$V_{SS}-0.3V \sim V_{DD}+0.3V$	V
Operating temperature	T_{OPR}	0 ~ +50	°C
Storage temperature	T_{STO}	-55 ~ 125	°C
Power consumption	P_D	500	mW

ELECTRICAL CHARACTERISTICS

(Ambient temperature is 25 °C, $V_{DD}=2.5V$ unless otherwise noted, all voltages referenced to V_{SS} , $F_{osc}=3.579545$ MHz)

Parameter	Sym.	Min.	Typ.	Max.	Unit	Condition	
Operating voltage	Pulse	2.0	-	5.5	V	unload	
	Tone	2.0	-	5.5			
Operating current($\overline{HKS}=0$)	Pulse	-	0.15	0.3	mA	unload	
	Tone	-	0.3	0.5			
	Pulse	-	0.15	0.3		with pull up/down resistor * 8	
	Tone	-	0.3	0.5			
Memory retention current		I_{mrt}	-	0.001	0.1	uA	$\overline{HKS}=1, V_{DD}=1V$
Standby current	$\overline{HKS}=1$	I_{stby}	-	0.001	0.1	uA	unload
	$\overline{HKS}=0$		-	1	10		
	$\overline{HKS}=1$		-	-0.001	0.1	with pull up/down resistor * 8	
	$\overline{HKS}=0$		-	10	30		
\overline{HKS} , \overline{HFI} pins: input voltage	V_{iH}	0.8V _{DD}	-	V _{DD}	V		
	V_{iL}	V _{SS}	-	0.2V _{DD}			
HFO & PM pins source current	I_{oH}	0.2	-	-	mA	$V_o = 2.0 V$	
\overline{PO} , HFO, \overline{XMUTE} , & PM, SDO pins: sink current	I_{oL}	-0.2	-	-	mA	$V_o = 0.5 V$	
\overline{PO} , \overline{XMUTE} and SDO pins: leakage current	I_{oH}	-	-	±0.001	uA	$V_o = V_{DD}$	
\overline{HFI} pin input resistance	R_{hfi}	-	200	-	KΩ	$V_{hfi} = V_{SS}$	
Keyboard scanning pins output current (except COL4/KT)	I_{oH}	2	10	50	uA	$V_{ksn}=V_{SS}$	
	I_{oL}	200	400	800		$V_{ksn}=V_{DD}$	
COL4/KT source current sink current	I_{oH}	0.2	-	-	mA	$V_o=2.0V$	
	I_{oL}	0.2	-	-		$V_o=0.5V$	

ELECTRICAL CHARACTERISTIC

(Ambient temperature is 25°C, $V_{DD}=2.5V$ unless otherwise noted, all voltages referenced to V_{SS} , $F_{osc}=3.579545$ MHz)

Parameter	Sym.	Min.	Typ.	Max.	Unit	Condition
Keyboard debounce time	Tdb	-	20	-	ms	
Key tone signal:						
frequency	Fkt	-	600	-	Hz	
present duration	Tkt	-	30	-	ms	
Pause time and pulse to tone	Tp	-	3.6	-	sec.	COL2=NR
	Tpt	-	2	-	sec.	COL2=R-Vss
Flash time	Tf	-	600	-	ms	Row3, Row4=NR, NR
		-	100	-		Row3, Row4=NR, R-Vss
		-	80	-		Row3, Row4=R-Vss, NR
		-	300	-		Row3, Row4=R-Vss,R-Vss
Flash pause time	Tfp	-	300	-	ms	
Pulse rate	PSR	-	20	-	pps	Row1 = R-Vdd
		-	10	-		Row1 = R-Vss
Make/Break ratio	MBR	-	40:60	-	%	Row2 = NR
		-	33:66	-		Row2 = R-Vss
Inter-digit pause time	Tidp	-	800	-	ms	PSR = 10 pps
		-	500	-		PSR = 20 pps
DTMF pin: sink current	IoL	-0.2	-	-	mA	Vdtmf = 0.5 V
DTMF signal DC level	Vdc	0.5	-	0.75	Vdd	Vdd = 2.0V ~ 5.5V
DTMF signal: ac level	Vdtmf	142	160	180	mVrms	Row group
pre-emphase	Twist	1	2	3	dB	Column - Row
distortion	THD	-	-30	-23	dB	RL = 5 KΩ
load resistance	ZL	5	-	-	KΩ	THD <-23dB
Minimum tone duration	T _D	96	98	100	ms	Memory dialing
		88	90	92		
		81	83	85		
Minimum inter-tone pause	Titp	96	98	100	ms	Memory dialing
		88	90	92		
		81	83	85		
SDO every bit time	Tbit	3.8	3.9	4.1	ms	

DTMF output frequency (fosc = 3.579545 MHz)

Keyboard scan pin	CCITT standard (Hz)	Actual output (Hz)	Deviation (%)
ROW1 (f1)	697	699.1	0.30
ROW2 (f2)	770	766.2	0.49
ROW3 (f3)	852	847.4	-0.53
ROW4 (f4)	941	947.9	0.73
COL1 (f5)	1209	1215.8	0.56
COL2 (f6)	1336	1331.6	-0.32
COL3 (f7)	1477	1471.8	-0.35

* This specification are subject to be changed without notice.

TIMING DIAGRAM

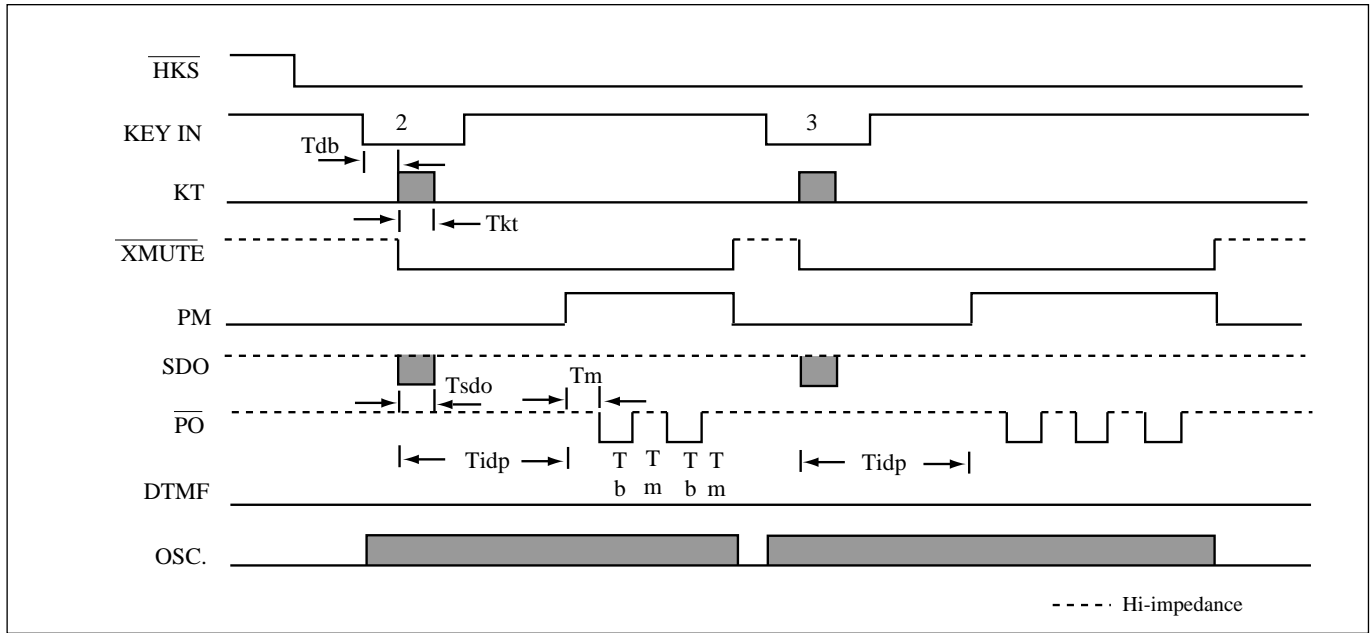

Figure 1. Pulse mode operating timing

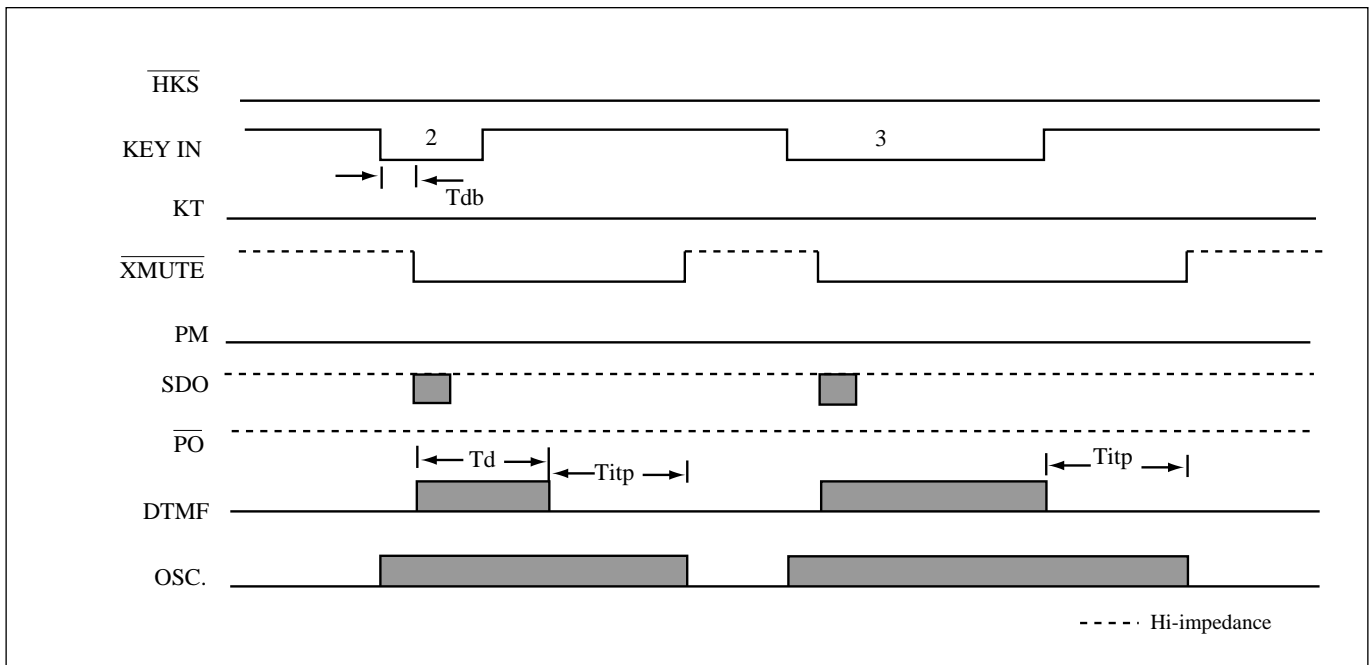

Figure 2. DTMF mode operating timing

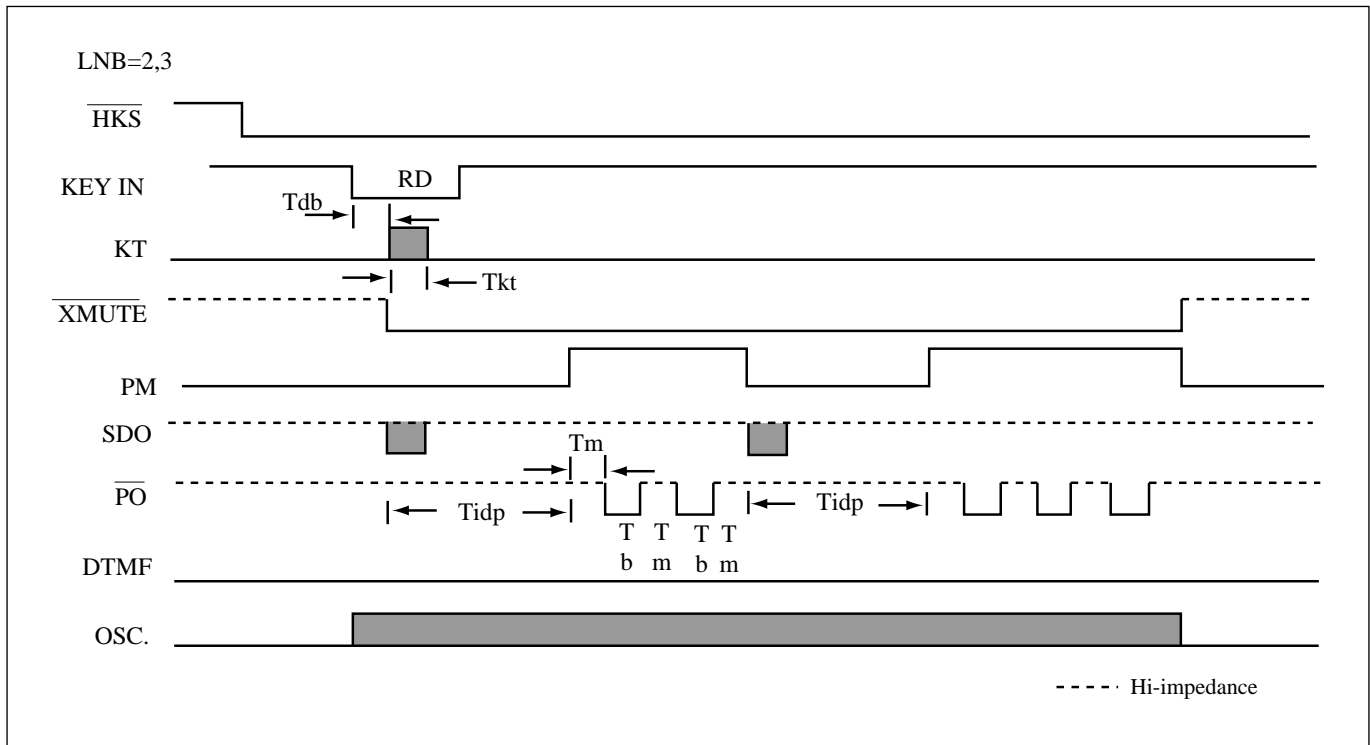

Figure 3. Pulse mode LNB redial timing

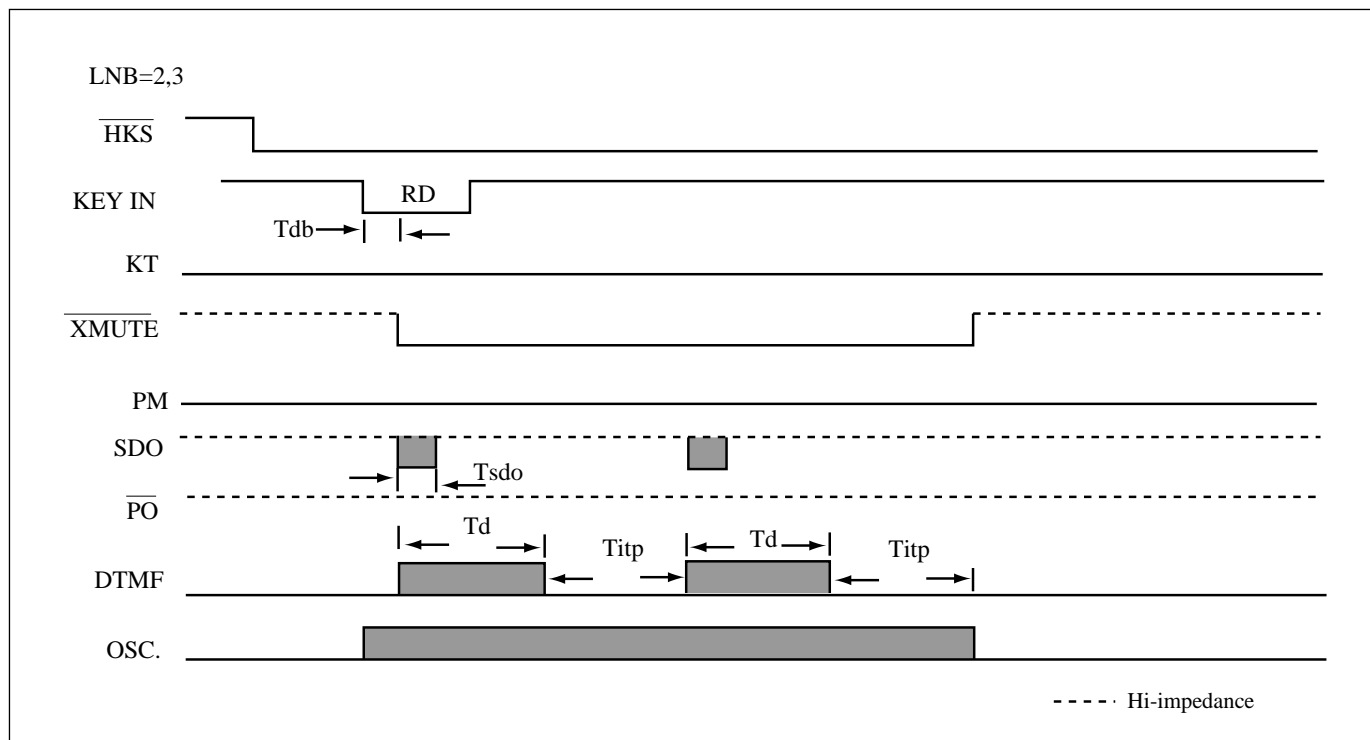

Figure 4. DTMF mode LNB redial timing

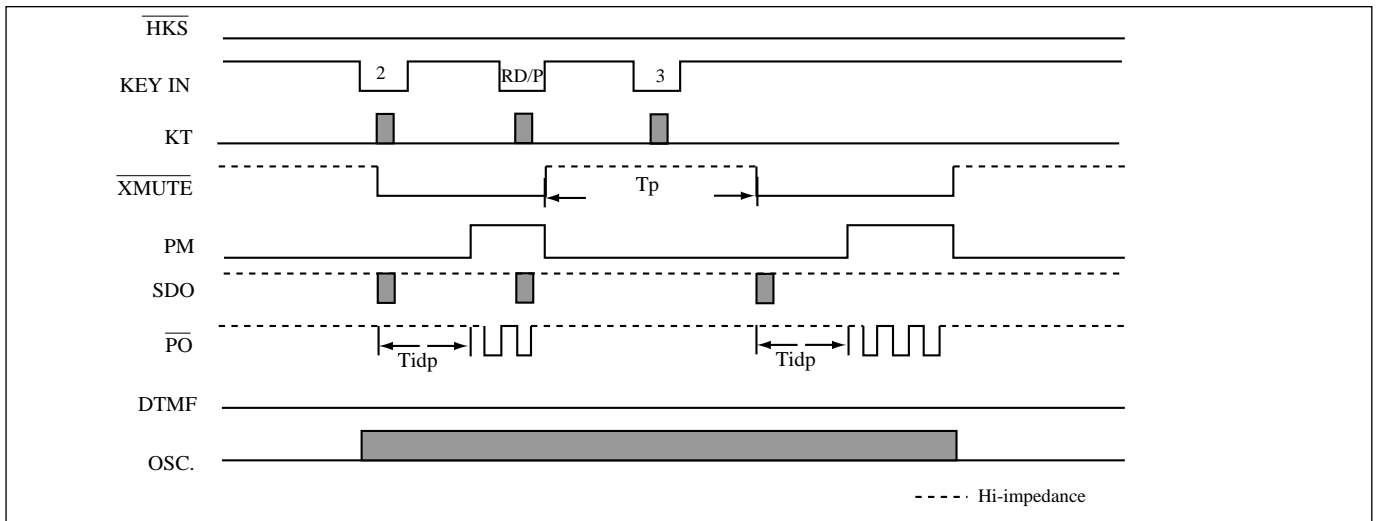

Figure 5. Pause key operating timing

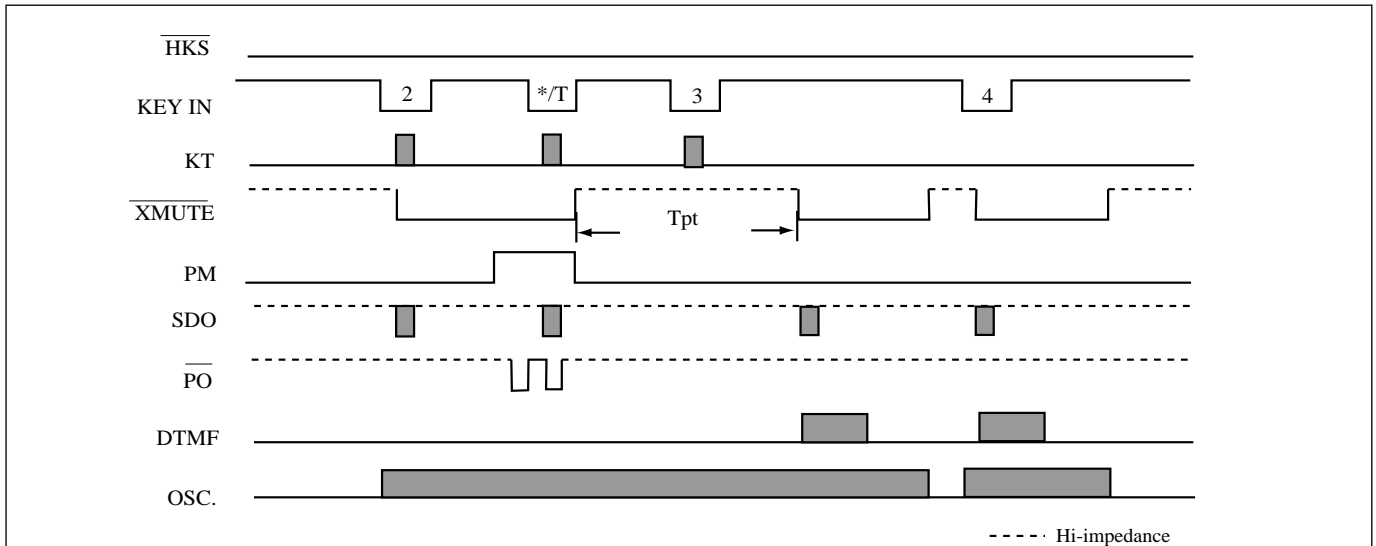

Figure 6. Pulse to Tone (P→T) operating timing

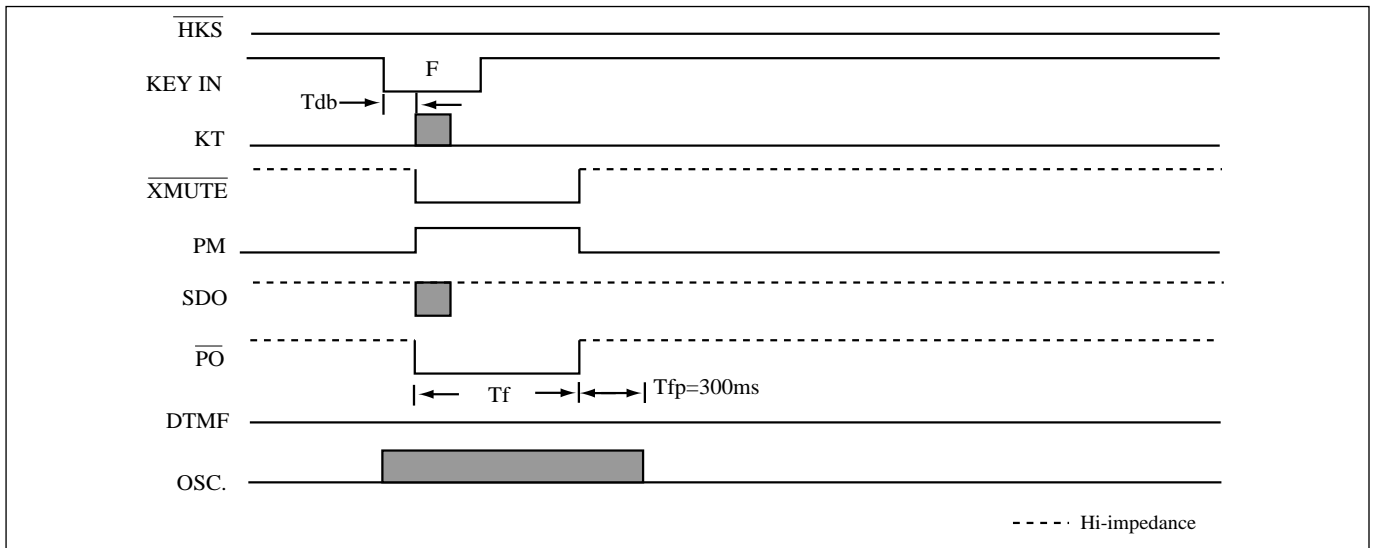
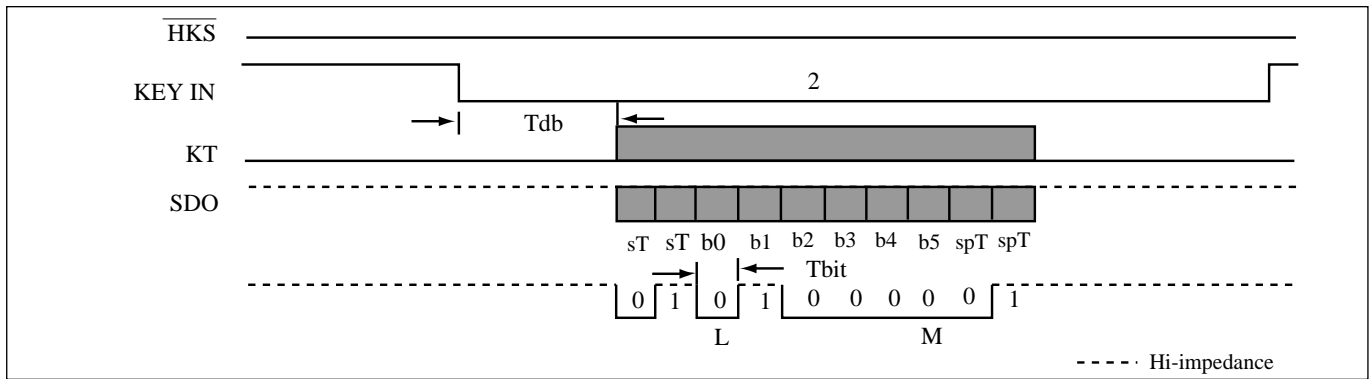

Figure 7. Flash key operating timing



<Note>L=LSB,M=MSB, sT=START bit time, spT=STOP bit time

Figure 8. SDO operating timing

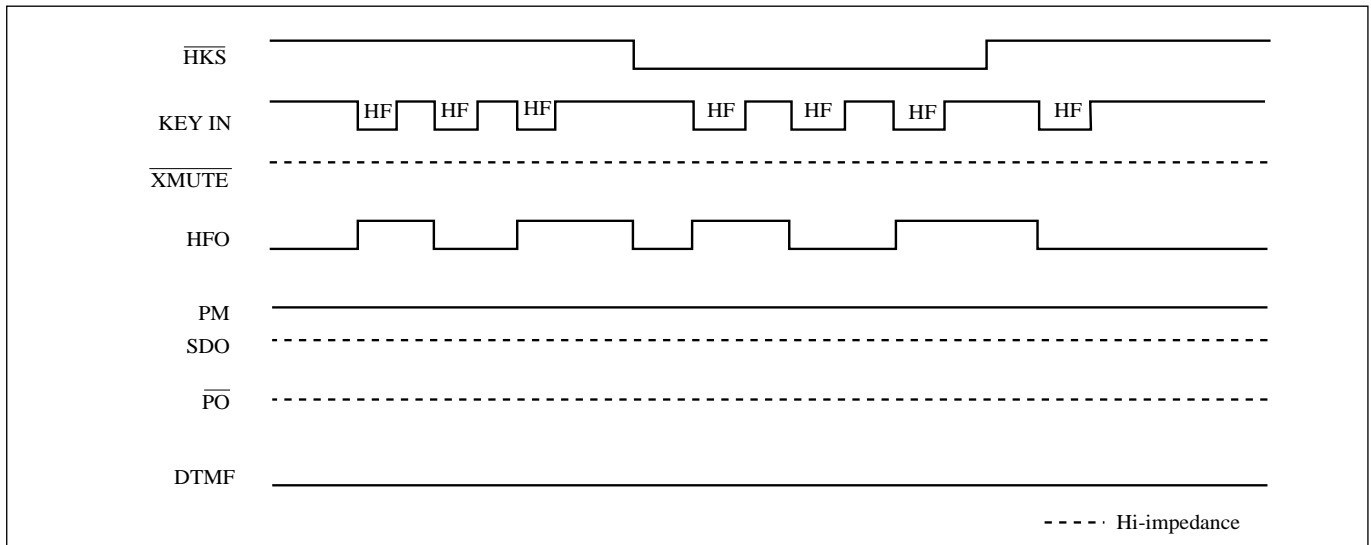
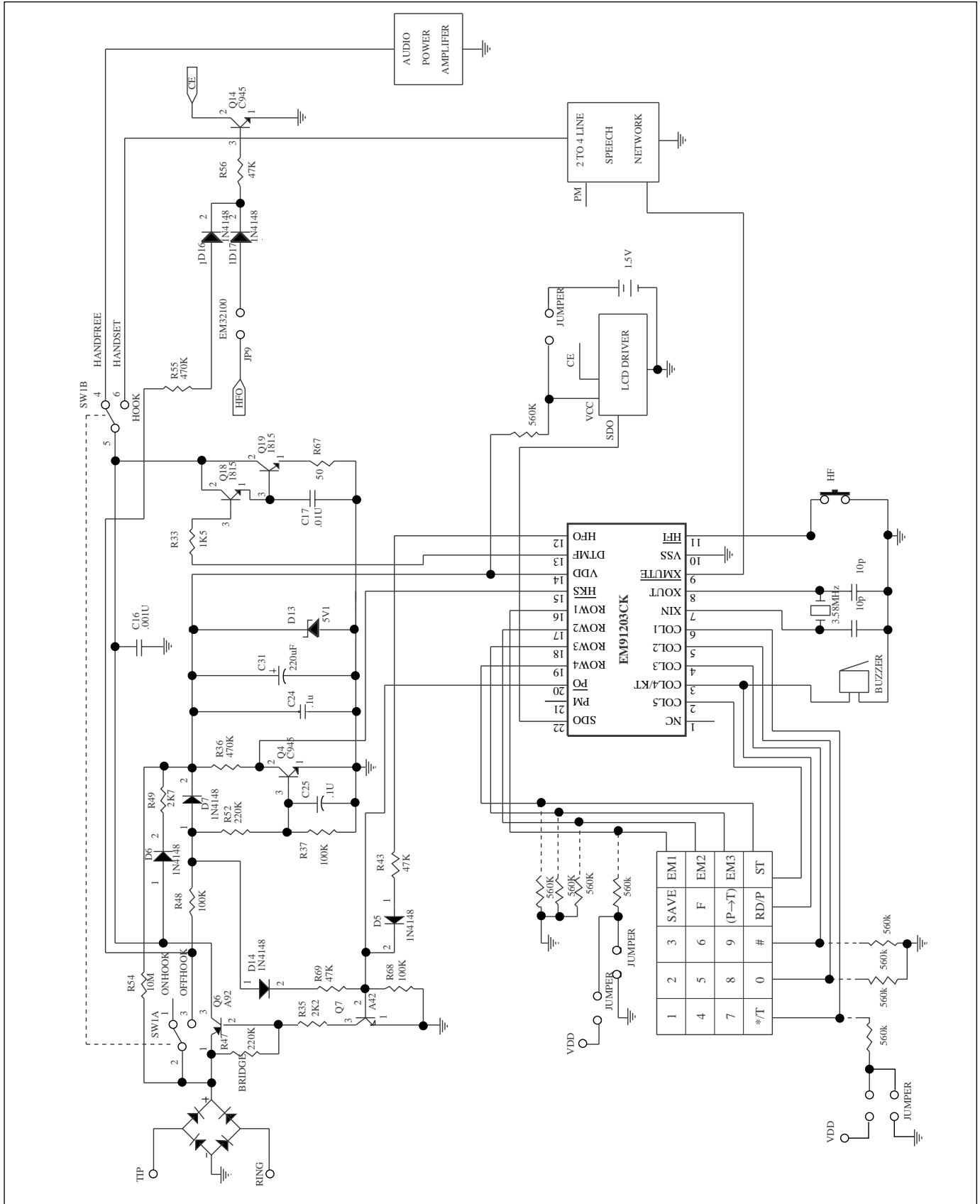

Figure 9. HF operating timing

APPLICATION CIRCUIT



* This specification are subject to be changed without notice.

EM32116 Application Circuit :

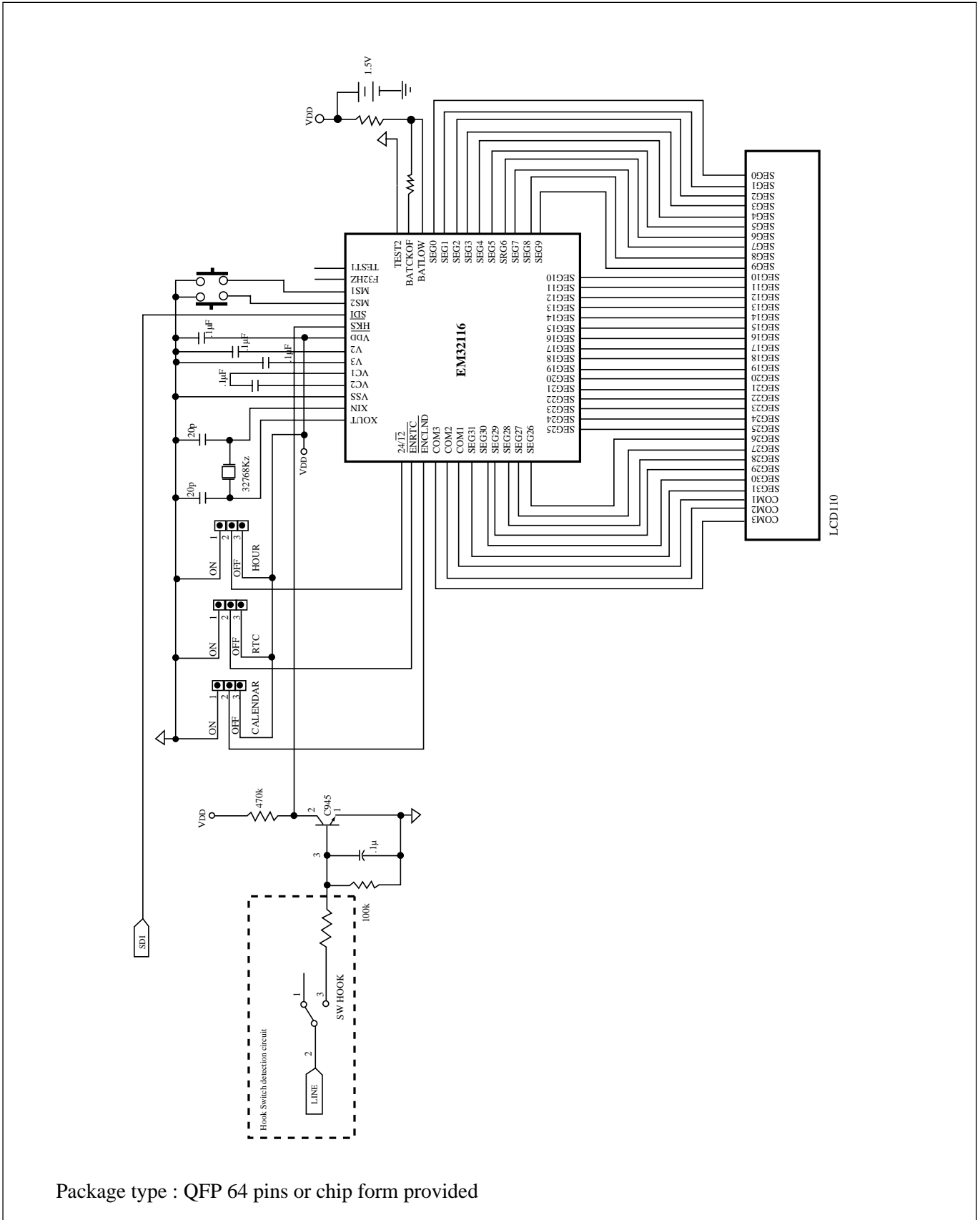

Package type : QFP 64 pins or chip form provided

* This specification are subject to be changed without notice.

PACKAGE INFORMATION

Example :

EM 91203 P
 (1) (2) (3)

- (1) ELAN MICRO. pefix
- (2) Type number
- (3) Package code:
 P→PDIP
 K→Skinny
 R→SDIP

18/20/28 Lead Plastic Package

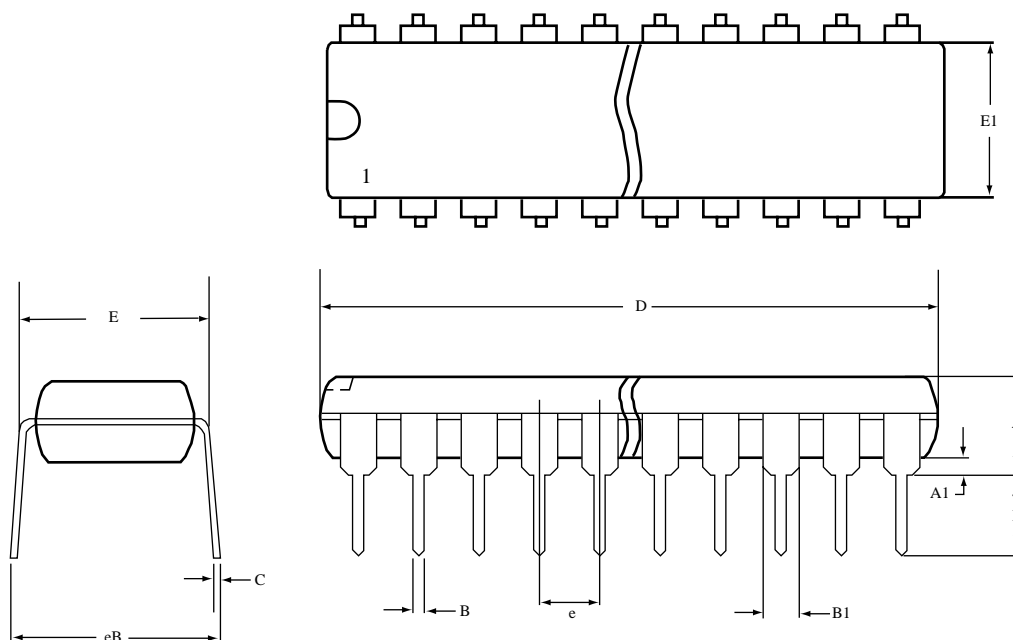

DIM	18 PDIP				20 PDIP				28 PDIP					
	MILIMETERS		INCHES		MILIMETERS		INCHES		MILIMETERS		INCHES			
	MIN.	MAX.	MIN.	MAX.	DIM	MIN.	MAX.	MIN.	MAX.	DIM	MIN.	MAX.	MIN.	MAX.
A	-	5.334	-	.210	A	-	5.334	-	.210	A	-	6.350	-	.250
A1	0.381	-	.015	-	A1	0.381	-	.015	-	A1	0.381	-	.015	-
B	0.356	0.558	.014	.022	B	0.356	0.558	.014	.022	B	0.356	0.558	.014	.022
B1	1.150	1.778	.045	.070	B1	1.150	1.778	.045	.070	B1	1.016	1.778	.040	.070
C	0.204	0.381	.008	.015	C	0.204	0.381	.008	.015	C	0.204	0.381	.008	.015
D	22.35	23.37	.880	.920	D	25.40	26.67	1.000	1.050	D	35.56	37.85	1.400	1.490
E	7.620	8.255	.300	.325	E	7.620	8.255	.300	.325	E	15.24	15.88	.600	.625
E1	6.096	7.112	.240	.280	E1	6.096	7.112	.240	.280	E1	13.21	14.73	.520	.580
e	2.286	2.794	.090	.110	e	2.286	2.794	.090	.110	e	2.286	2.794	.090	.110
eB	-	10.92	-	.430	eB	-	10.92	-	.430	eB	-	17.78	-	.700
L	2.921	4.064	.115	.160	L	2.921	4.064	.115	.160	L	2.921	5.080	.115	.200

* This specification are subject to be changed without notice.

22/24 Lead Plastic Package-Skinny

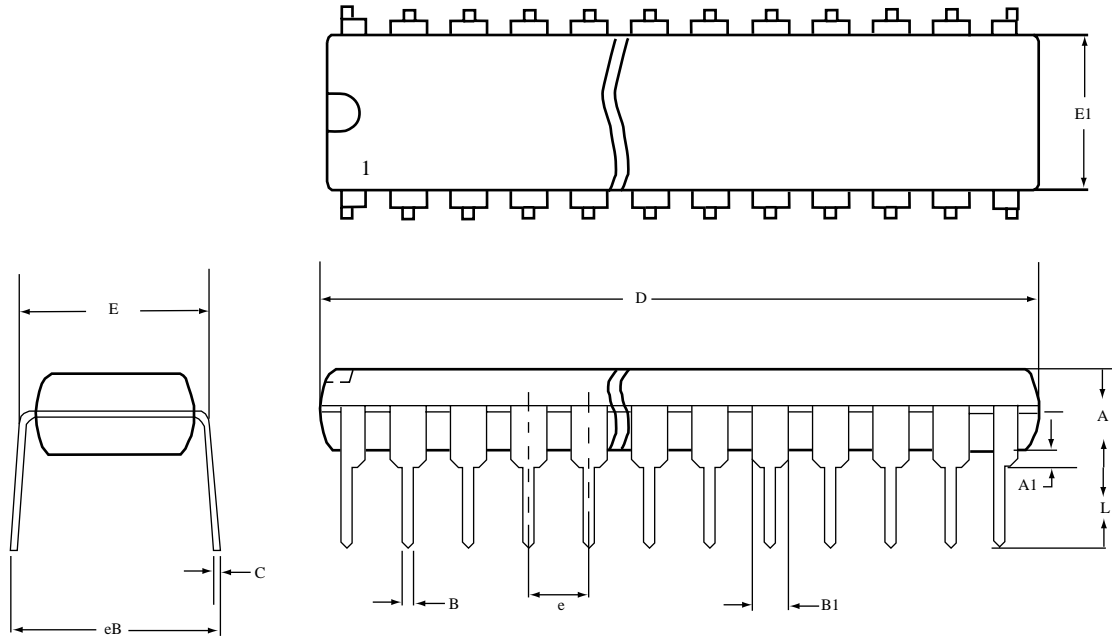

22 PDIP (skinny)					24 PDIP (skinny)				
DIM	MILIMETERS		INCHES		DIM	MILIMETERS		INCHES	
	MIN.	MAX.	MIN.	MAX.		MIN.	MAX.	MIN.	MAX.
A	-	4.752	-	.180	A	-	4.572	-	.180
A1	0.381	-	.015	-	A1	0.381	-	.015	-
B	0.356	0.558	.014	.022	B	0.356	0.558	.014	.022
B1	1.27	1.778	.050	.070	B1	1.27	1.778	.050	.070
C	0.204	3.556	.008	.014	C	0.204	0.381	.008	.015
D	25.90	26.67	1.02	1.05	D	31.24	32.26	1.23	1.270
E	7.620	8.255	.300	.325	E	7.620	8.255	.300	.325
E1	6.223	6.604	.245	.260	E1	6.223	6.731	.245	.265
e	2.286	2.794	.090	.110	e	2.286	2.794	.090	.110
eB	8.382	10.16	.330	.400	eB	8.636	9.652	.340	.380
L	2.921	4.064	.115	.160	L	2.921	4.064	.115	.160

42 SDIP Package

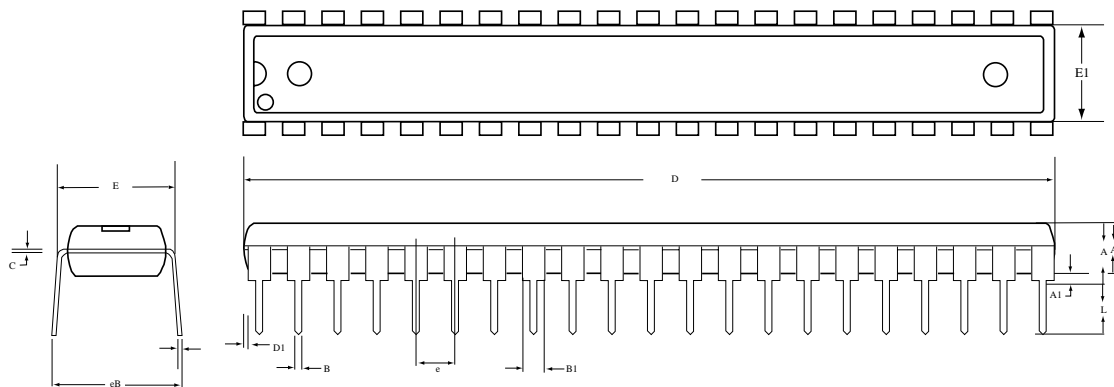

42 SDIP				
DIM	MILIMETERS		INCHES	
	MIN.	MAX.	MIN.	MAX.
A	-	5.08	-	0.200
A1	0.381	-	0.015	-
A2	3.937	4.191	0.155	0.165
B	0.356	0.559	0.014	0.022
B1	0.914	1.116	0.036	0.044
C	0.204	0.304	0.008	0.012
D	36.70	37.34	1.445	1.470
E1	13.84	14.10	0.545	0.555
e	1.727	1.829	0.068	0.072
eB	15.24	17.78	0.600	0.70
D1	0	0.127	0	0.005
L	2.921	3.429	0.115	0.135