

# CXA1665M/M-S

## All Band TV Tuner IC (VHF-CATV-UHF)

### Description

The CXA1665M/M-S is a single chip TV tuner IC which performs as an oscillator, mixer for VHF/CATV and UHF bands. An IF amplifier is also provided.

This IC adopts a 16-pin SOP package in response to the trend toward miniaturizing the tuner and automatic IC mounting. This IC achieves a large reduction of external parts in addition to miniaturizing the tuner and increasing manufacturing productivity, reliability and design efficiency.

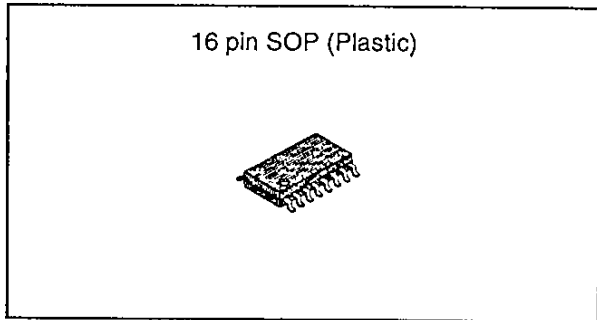

### Features

- On-chip oscillator and mixer for UHF band
- Low noise figure
- Reduced spurious interference
- Superior cross modulation distortion
- Stable oscillating characteristics

### Applications

- CTV tuner
- CATV UP-DOWN converter
- FM detector for 2nd IF satellite broadcasts

### Absolute Maximum Ratings (Ta=25°C)

• Supply voltage	Vcc	11	V
• Storage temperature	Tstg	-65 to +150	°C
• Allowable power dissipation	Pd	980	mW

(When mounted on a board)

### Structure

Bipolar silicon monolithic IC

### Operating Conditions

• Supply voltage	Vcc	9.0±0.9	V
• Operating temperature	Topr	-20 to +75	°C

### Block Diagram and Pin Configuration (Top View)

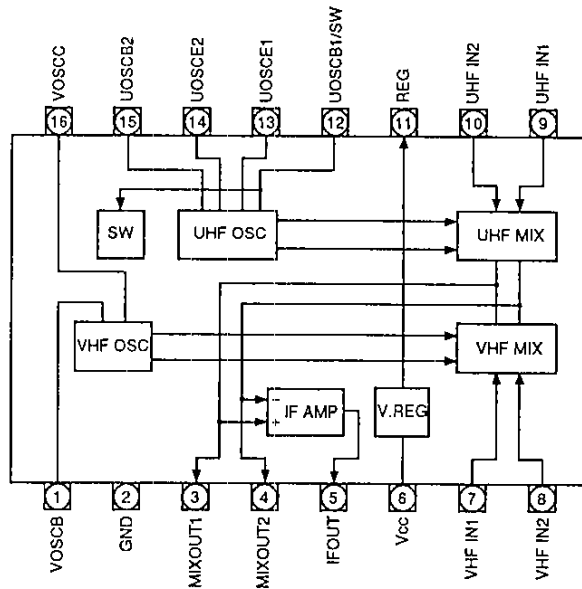

Sony reserves the right to change products and specifications without prior notice. This information does not convey any license by any implication or otherwise under any patents or other right. Application circuits shown, if any, are typical examples illustrating the operation of the devices. Sony cannot assume responsibility for any problems arising out of the use of these circuits.

Pin Description and Equivalent Circuit

Pin No.	Symbol	Typical voltage (V)	Equivalent circuit	Description
1	VOSC B	Under VHF operation; 3.5 Under UHF operation; 3.7		VHF oscillator.
16	VOSC C	6.7 9.0		
2	GND	0		GND
3	MIX OUT1	7.5 7.3		Mixer output and IF amplifier input.
4	MIX OUT2	7.5 7.3		
5	IF OUT	4.5 4.5		IF output.
6	Vcc	9		Power supply.

Pin No.	Symbol	Typical voltage (V)	Equivalent circuit	Description
7	VHF IN1	3.2		<p>VHF input; normally a decoupling capacitor is connected at Pin 7 to GND and Pin 8 is used for input.</p>
		3.3		
8	VHF IN2	3.2		
		3.3		
9	UHF IN1	3.3		<p>UHF input. The balanced input to Pins 9 and 10, or a decoupling capacitor is connected at Pin 10 to GND and Pin 9 is used for input.</p>
		3.2		
10	UHF IN2	3.3		
		3.2		
11	REG	6		Regulator output.
12	UOSC B1/SW	0		<p>UHF oscillator. Pin 12 is used for both U/V switches.</p>
13	UOSC E1	3.4		
		0		
14	UOSC E2	2.6		
		3.2		
15	UOSC B2	2.6		
		3.7		
		3.4		

## Electrical Characteristics

(See Electrical Characteristics Test Circuit. Ta=25°C, Vcc=9V)

Item	Symbol	Condition	Min.	Typ.	Max.	Unit
Circuit current	IccV	VHF operation; no signal	30	45	58	mA
	IccU	UHF operation; no signal	29	44	57	mA
Conversion gain *1	CG1	VHF operation; fRF=55MHz; Input level -40dBm	20	23	26	dB
	CG2	VHF operation; fRF=360MHz; Input level -40dBm	20	23	26	dB
	CG3	UHF operation; fRF=360MHz; Input level -40dBm	25	28	31	dB
	CG4	UHF operation; fRF=800MHz; Input level -40dBm	25	28	31	dB
Noise figure *1 *2	NF1	VHF operation; fRF=55MHz		10	13	dB
	NF2	VHF operation; fRF=360MHz		10	13	dB
	NF3	UHF operation; fRF=360MHz		7	11	dB
	NF4	UHF operation; fRF=800MHz		8	12	dB
1% cross modulation *1 *3	CM1	VHF operation; fd=55MHz, fUD=±12MHz	96	100		dB μ
	CM2	VHF operation; fd=360MHz, fUD=±12MHz	94	98		dB μ
	CM3	UHF operation; fd=360MHz, fUD=±12MHz	88	92		dB μ
	CM4	UHF operation; fd=800MHz, fUD=±12MHz	87	91		dB μ
Max. output power	Pomax (sat)	50 Ω load	+8	+11		dBm
Switch ON drift	Δ fsw1	VHF operation; fosc=100MHz frequency drift for the time from 3s to 3min after switch ON			±300	kHz
	Δ fsw2	VHF operation; fosc=405MHz frequency drift for the time from 3s to 3min after switch ON			±500	kHz
	Δ fsw3	UHF operation; fosc=405MHz frequency drift for the time from 3s to 3min after switch ON			±500	kHz
	Δ fsw4	UHF operation; fosc=845MHz frequency drift for the time from 3s to 3min after switch ON			±500	kHz
+B supply voltage drift	Δ fst1	VHF operation; fosc=100MHz frequency shift when Vcc+9V changes ±5%			±200	kHz
	Δ fst2	VHF operation; fosc=405MHz frequency shift when Vcc+9V changes ±5%			±250	kHz
	Δ fst3	UHF operation; fosc=405MHz frequency shift when Vcc+9V changes ±5%			±250	kHz
	Δ fst4	UHF operation; fosc=845MHz frequency shift when Vcc+9V changes ±5%			±250	kHz

\*1) Measured value for untuned inputs.

\*2) Noise figure is uncorrected for image.

\*3) Desired signal (fd) input level is -33dBm.

undesired signal (fUD) is 100kHz at 30% AM.

The measurement value is undesired signal level, it measured with a spectrum analyzer at S/I=46dB.

Electrical Characteristics Test Circuit

Table 1. Inductance constant

Wire diameter	Coil diameter	Number of windings
L1	0.5	3.2
L2	0.5	3.2
L3	0.5	3.8
		1.5T

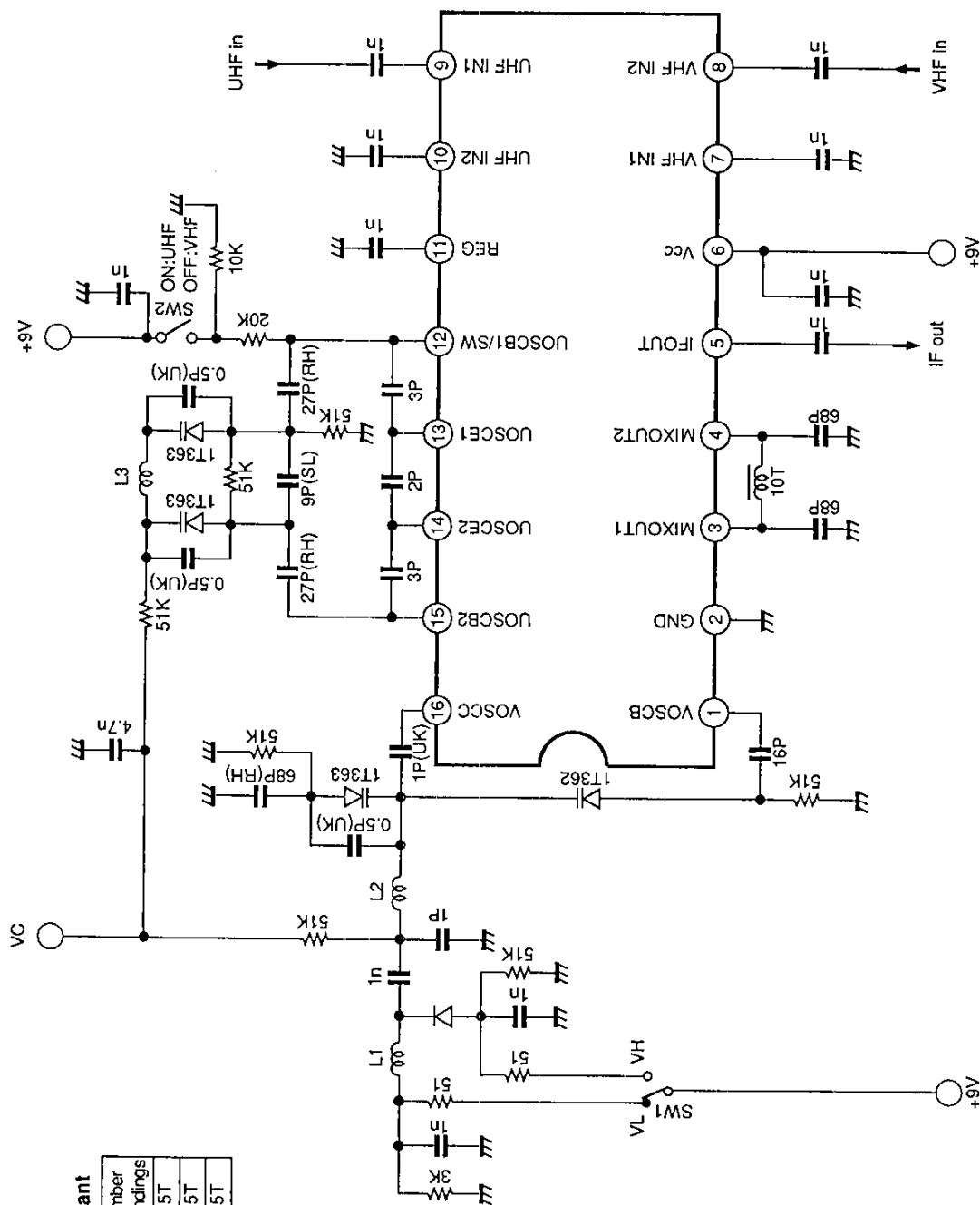

## Description of Operation (See Electrical Characteristics Test Circuit.)

### (1) VHF oscillator circuit

The differential oscillator circuit with an output at Pin 16 and an input at Pin 1.

Connect an LC resonance circuit comprising a varicap diode to Pin 16 through a coupling capacitor. The positive feedback from the resonance circuit is applied to Pin 1 through a feedback capacitor to execute oscillation. Note that if a parasitic capacitance across Pins 1 and 16 is too large, it may cause undesired oscillation.

### (2) VHF mixer circuit

This is a double-balanced mixer having small leakage of local oscillation signal. The RF signal is input to Pins 7 and 8. In normal use, the signal is input to one pin while the other pin is connected to GND by decoupling capacitor. The RF signal is converted to IF with the signal supplied from oscillator. The converted RF is sent to the IF amplifier and output to Pins 3 and 4 simultaneously.

### (3) UHF oscillator circuit

UHF oscillator is formed from two collector-grounded Colpitts oscillators, and oscillation is provided at the differential input through an LC resonator circuit including a varicap diode.

The Pin 12 also functions as UHF/VHF switch pin.

### (4) UHF mixer circuit

This is the double-balanced mixer like the VHF mixer. The RF signal is input to Pins 9 and 10. There is a balanced differential input from pre-stage double tune circuit, or an unbalanced input to Pin 9 with the capacitor connected at Pin 10 to GND. Balanced input achieves better NF rather than unbalanced input.

Otherwise, the conditions and usage are the same as those for the VHF mixer circuit.

### (5) IF amplifier circuit

The mixer output signal is amplified by the IF amplifier and output to Pin 5. The output impedance is about 75  $\Omega$ .

### (6) UHF/VHF switch circuit

UHF/VHF mode is selected by the DC voltage at Pin 12. UHF operation is chosen by inputting 9V through a 20k  $\Omega$  resistor, and VHF operation by inputting 0V. If the UHF switch voltage is 12V not 9V, adjust the resistance to approximately 30k $\Omega$  so that the DC voltage becomes almost equal between Pins 12 and 15. Be sure to connect a resistor for discharging (approx. 10k $\Omega$ ) if OPEN not 0V is chosen for the VHF switch voltage.

## Notes on Usage

Care should be taken such as grounding in placing external parts because high frequencies are present. Adjust accordingly to prevent heat problems with special care such as the GND pattern for heat dissipation at the portion for IC mount where heat dissipations accumulate.

Example of Representative Characteristics

Circuit current vs. Supply voltage

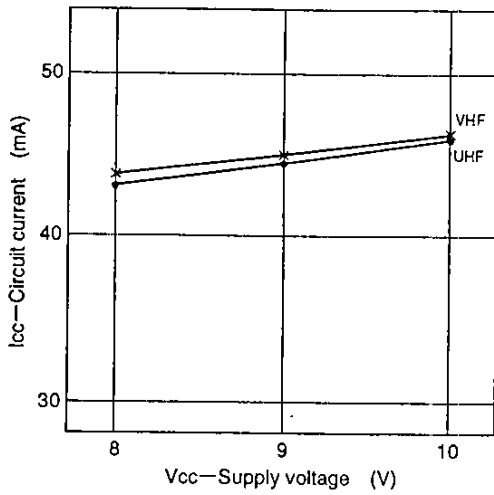

Conversion gain vs. Reception frequency (Untuned input)

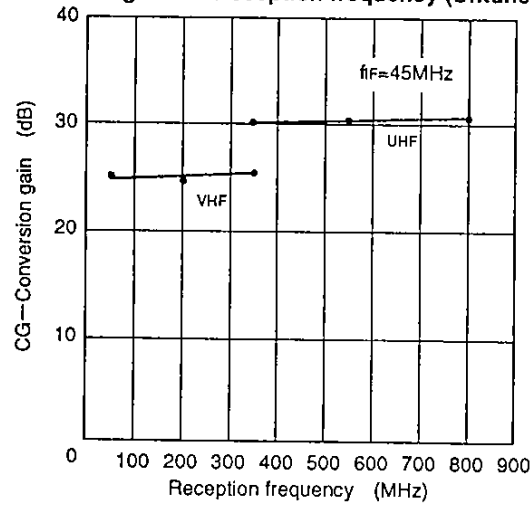

Noise figure vs. Reception frequency (Untuned input, In DSB)

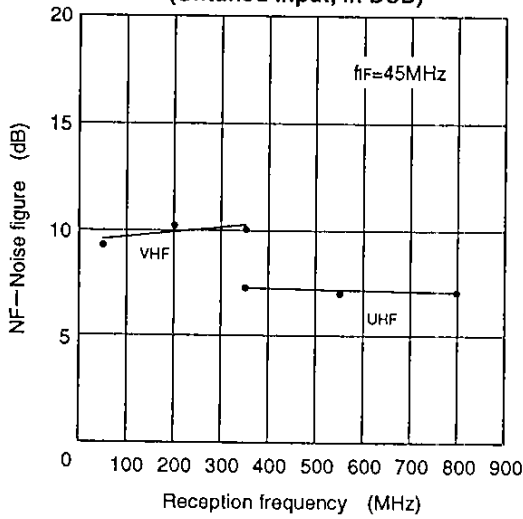

Next adjacent cross modulation vs. Reception frequency (Untuned input)

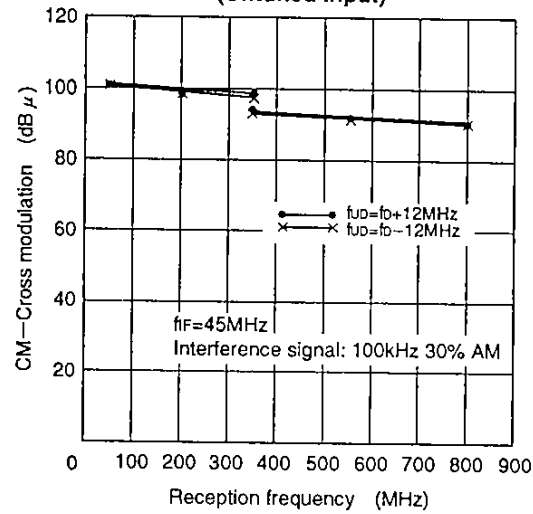

I/O characteristics (Untuned input)

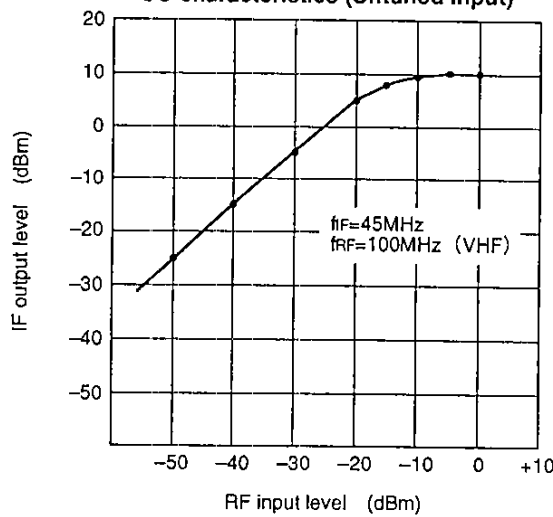

VHF Input Impedance

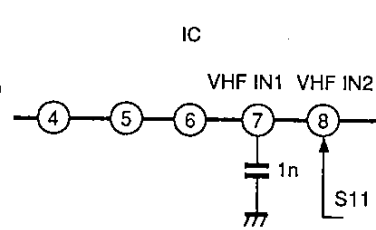
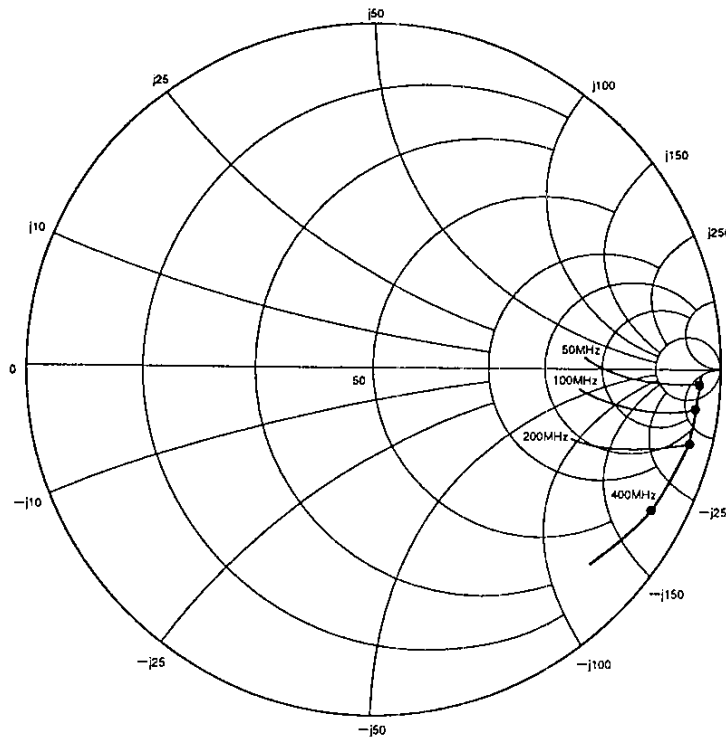

UHF Input Impedance

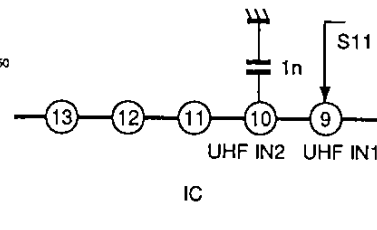
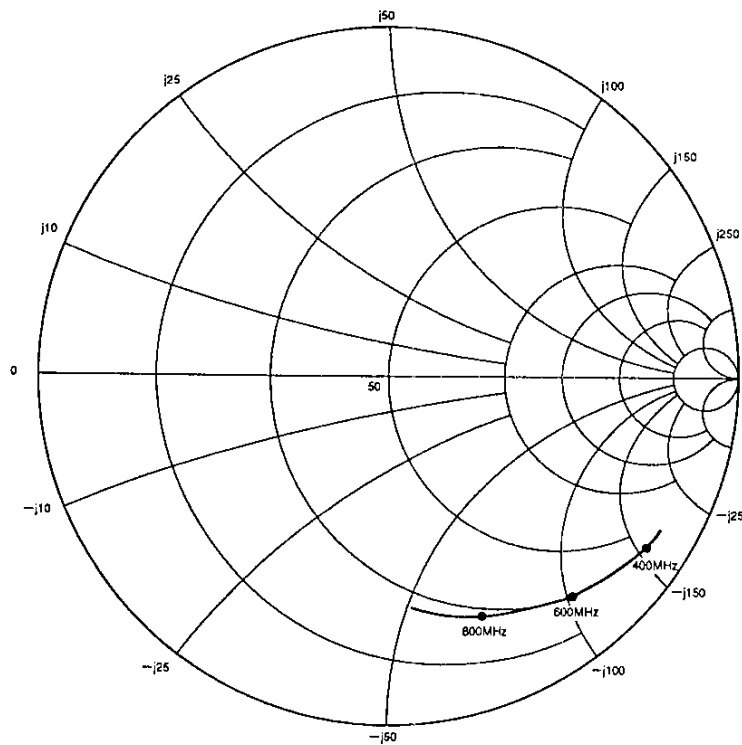



IF Output Impedance

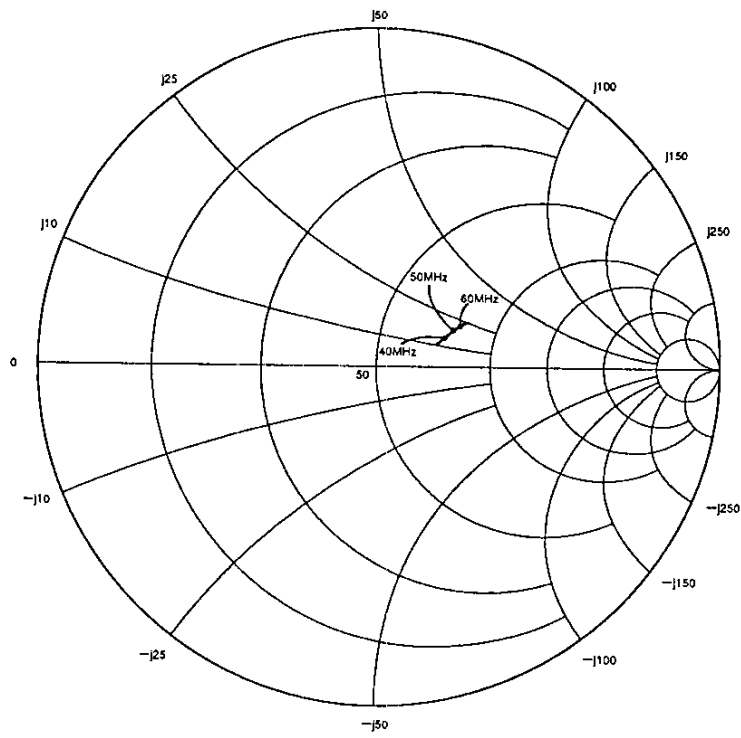

Package Outline

Unit: mm

CXA1665M

16 pin SOP (Plastic) 300mil 0.2g

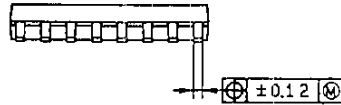
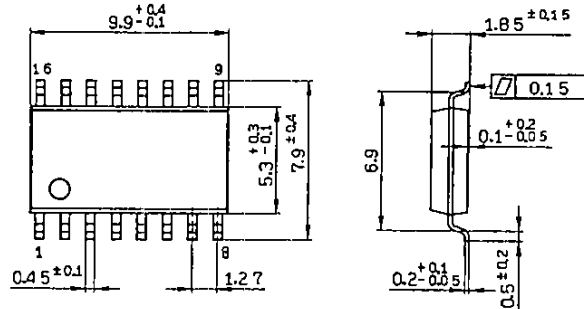

SONY NAME	SOP-16P-L01
EIAJ NAME	SOP016-P-0300-A
JEDEC CODE	

CXA1665M-S

16PIN SOP(PLASTIC)

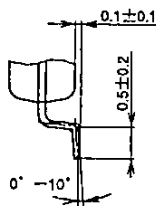
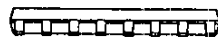
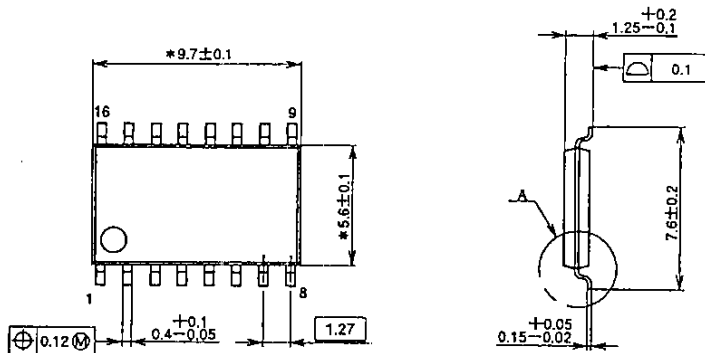

NOTE> "\*" Dimensions do not include mold protrusion.

DETAIL A

SONY CODE	SOP-16P-L04
EIAJ CODE	SOP016-P-0300
JEDEC CODE	

PACKAGE STRUCTURE

PACKAGE MATERIAL	EPOXY RESIN
LEAD TREATMENT	SOLDER/PALLADIUM PLATING
LEAD MATERIAL	COPPER ALLOY
PACKAGE WEIGHT	0.1g