



IPAD™

# EMIF06-10006F1

## 6 LINES EMI FILTER AND ESD PROTECTION

### MAIN PRODUCT CHARACTERISTICS

Where EMI filtering in ESD sensitive equipment is required:

- Mobile phones
- Computers and printers
- Communication systems
- MCU Boards

### DESCRIPTION

The EMIF06-10006F1 is a highly integrated devices designed to suppress EMI/RFI noise in all systems subjected to electromagnetic interferences. The EMIF06 flip-chip packaging means the package size is equal to the die size.

This filter includes an ESD protection circuitry which prevents the device from destruction when subjected to ESD surges up 15kV. This device includes 6 EMIF filters.

### BENEFITS

- EMI symmetrical (I/O) low-pass filter
- High efficiency in EMI filtering
- Very low PCB space consuming:  
2.92mm x 1.29mm
- Very thin package: 0.65 mm
- High efficiency in ESD suppression  
(IEC61000-4-2 level 4)
- High reliability offered by monolithic integration
- High reducing of parasitic elements through integration and water level packaging.

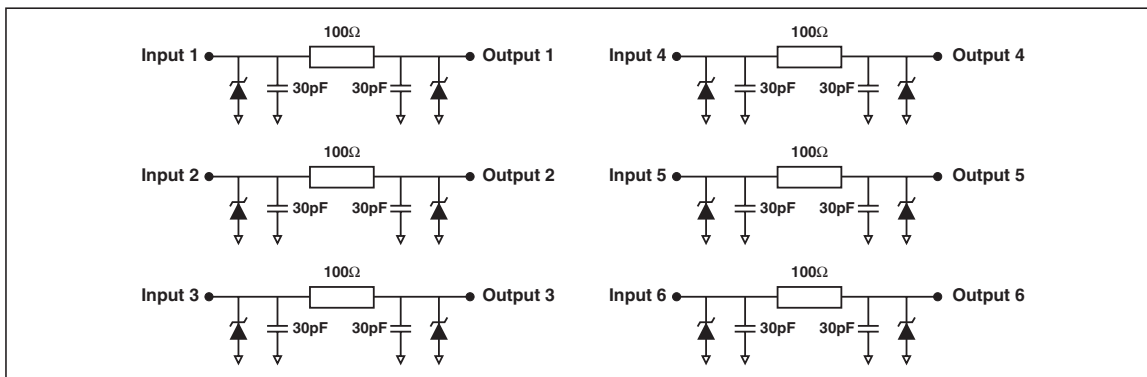
### COMPLIES WITH THE FOLLOWING STANDARDS :

IEC 61000-4-2 level 4:

15kV (air discharge)  
8 kV (contact discharge)

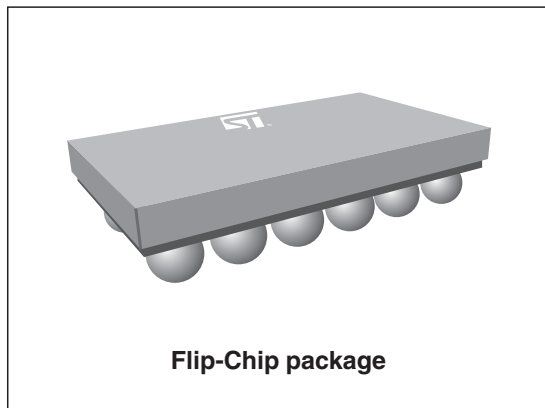
MIL STD 883E - Method 3015-6 Class 3: 30kV

### BASIC CELL CONFIGURATION

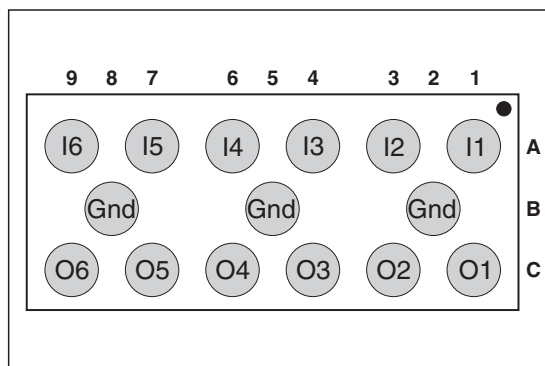


TM : IPAD is a trademark of STMicroelectronics.

March 2004 - Ed: 2



### PIN CONFIGURATION (ball side)

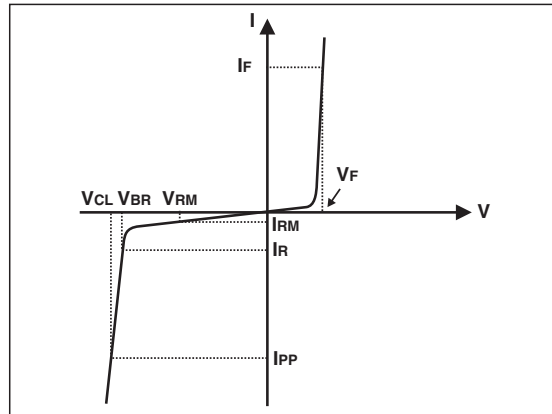


**ABSOLUTE RATINGS** (limiting values)

Symbol	Parameter and test conditions	Value	Unit
$P_R$	DC power per resistance	0.1	W
$P_T$	Total DC power per package	0.6	W
$T_j$	Maximum junction temperature	125	°C
$T_{op}$	Operating temperature range	-40 to + 85	°C
$T_{stg}$	Storage temperature range	125	°C

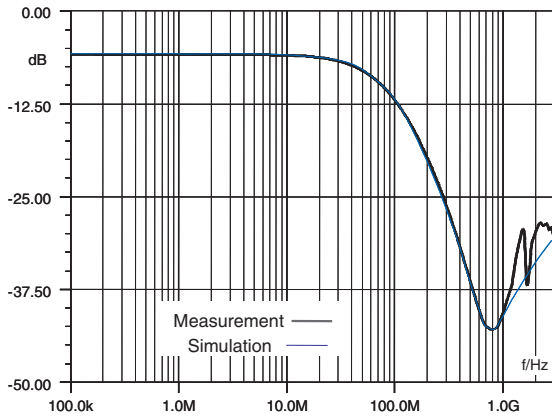
**ELECTRICAL CHARACTERISTICS** ( $T_{amb} = 25\text{ °C}$ )

Symbol	Parameter
$V_{BR}$	Breakdown voltage
$I_{RM}$	Leakage current @ $V_{RM}$
$V_{RM}$	Stand-off voltage
$V_{CL}$	Clamping voltage
$R_d$	Dynamic impedance
$I_{PP}$	Peak pulse current
$R_{I/O}$	Series resistance between Input and Output
$C_{line}$	Capacitance per line

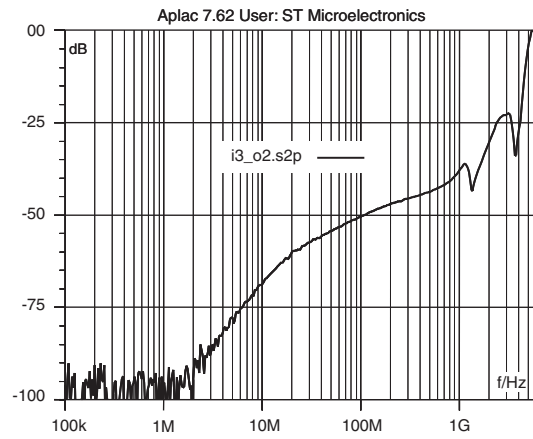


Symbol	Test conditions	Min.	Typ.	Max.	Unit
$V_{BR}$	$I_R = 1\text{ mA}$	5.5	7	9	V
$I_{RM}$	$V_{RM} = 3.3\text{ V per line}$			500	nA
$R_{I/O}$	$I = 10\text{ mA}$	80	100	120	$\Omega$
$C_{line}$	$V_R = 2.5\text{ V}, F = 1\text{ MHz}, 30\text{ mV (on filter cells)}$	50	60	70	pF

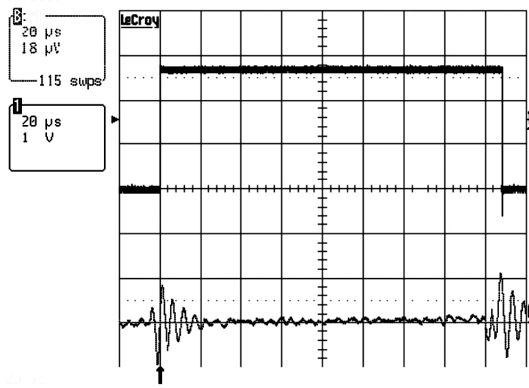
**Fig. 1:** S21 (dB) attenuation measurements and Aplac simulation.



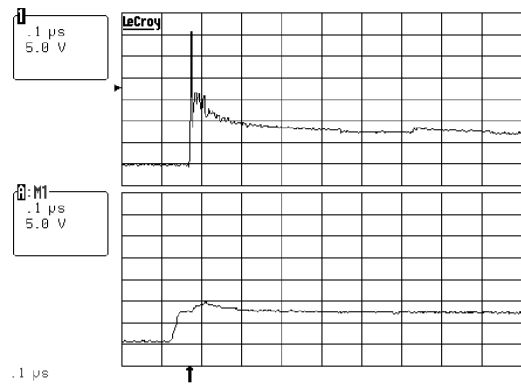
**Fig. 2:** Analog crosstalk measurements.



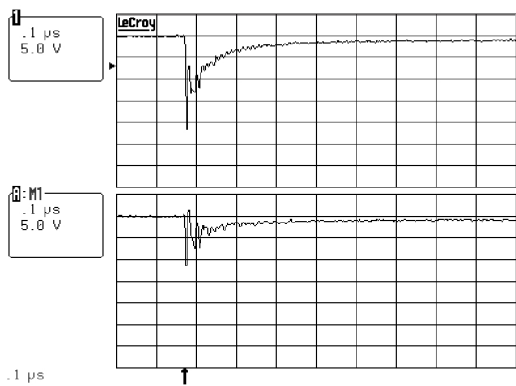
**Fig. 3:** Digital crosstalk measurements.



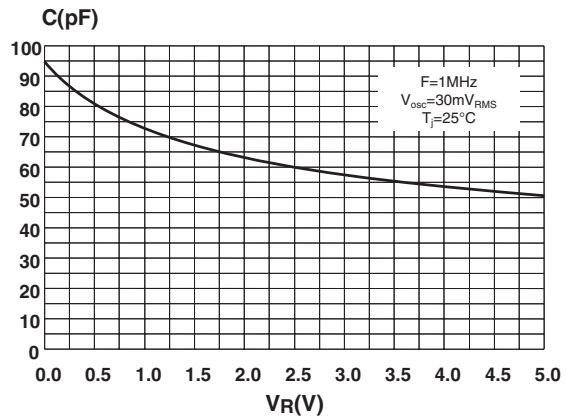
**Fig. 4:** ESD response to IEC61000-4-2 (+15kV air discharge) on one input V(in) and one output V(out).



**Fig. 5:** ESD response to IEC61000-4-2 (-15kV air discharge) on one input V(in) and one output V(out).

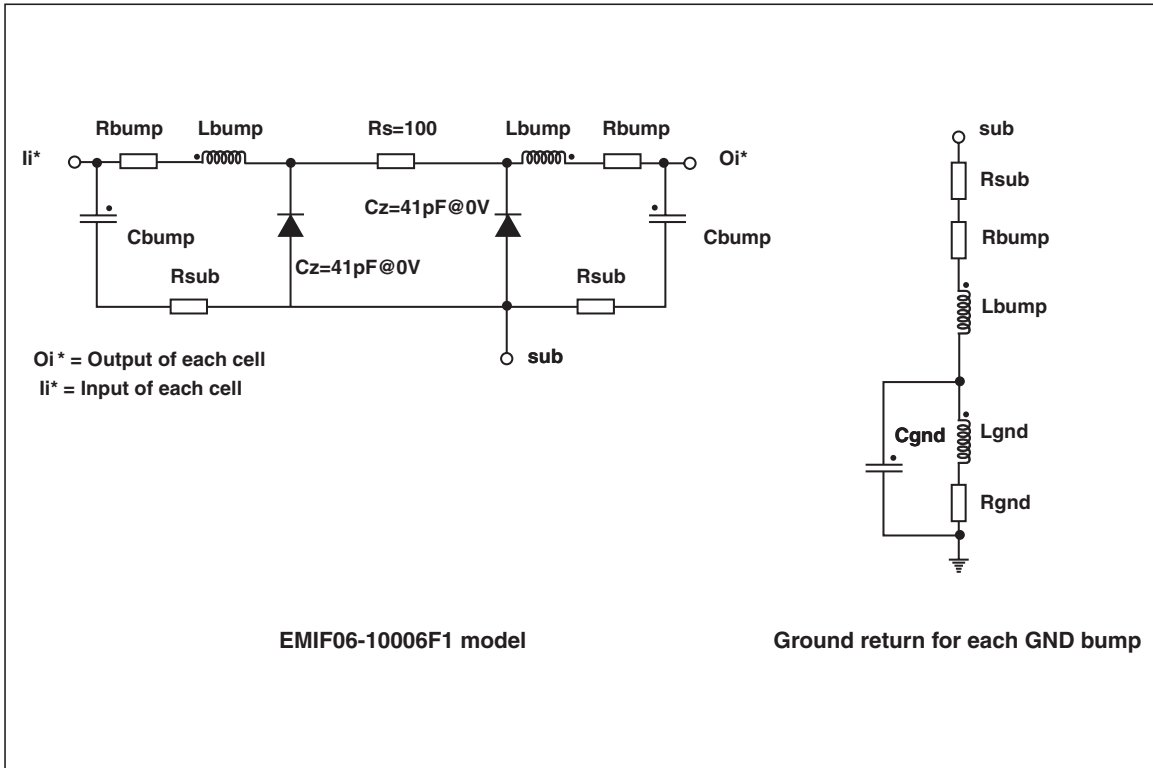


**Fig. 6:** Line capacitance versus applied voltage for filter.



## EMIF06-10006F1

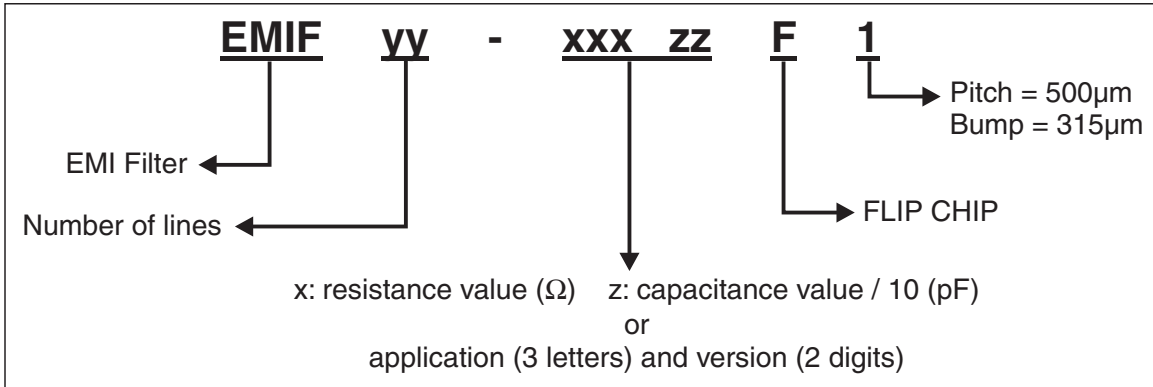
### Aplac model



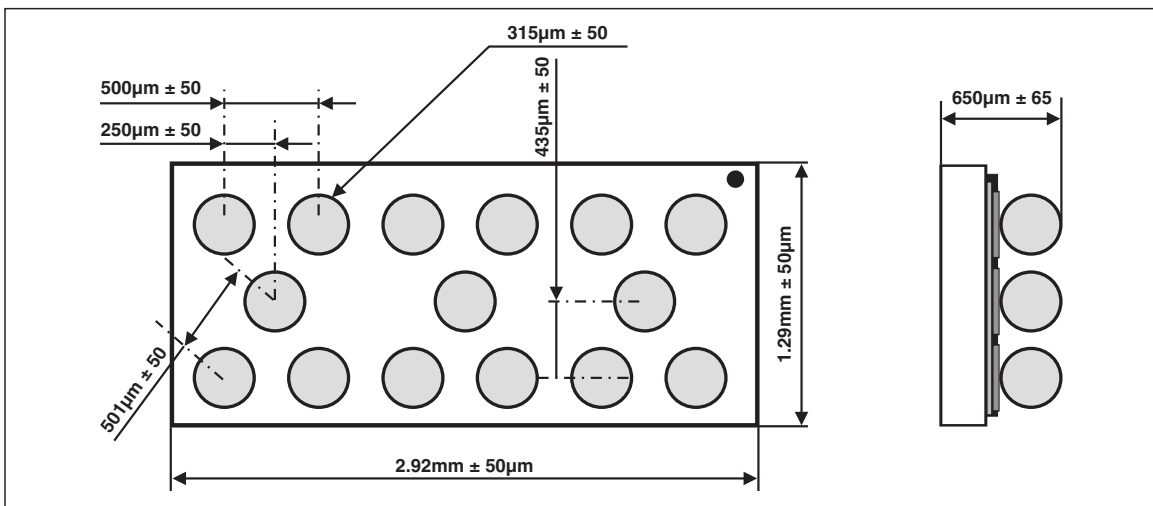
### Aplac parameters

aplacevar $R_s$	100 $\Omega$
aplacevar $C_z$	41 pF
aplacevar $L_{bump}$	50 pH
aplacevar $R_{bump}$	20 m
aplacevar $C_{bump}$	1.2 pF
aplacevar $R_{sub}$	100 m
aplacevar $R_{gnd}$	100 m
aplacevar $L_{gnd}$	100 pH
aplacevar $C_{gnd}$	0.15 pF

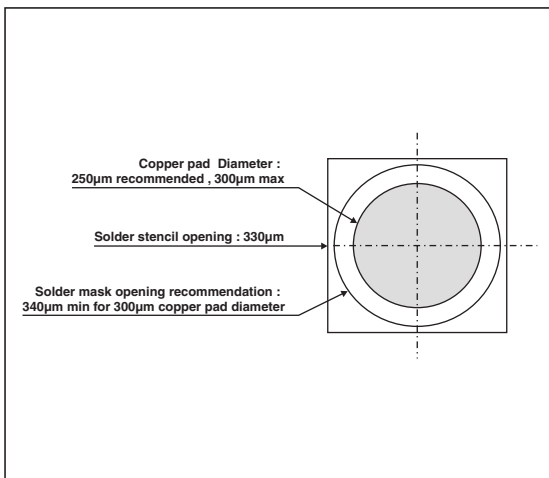
**ORDER CODE**



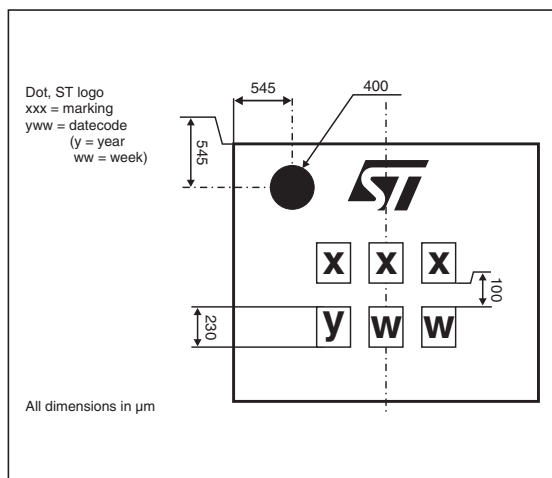
**PACKAGE MECHANICAL DATA**



**FOOT PRINT RECOMMENDATIONS**

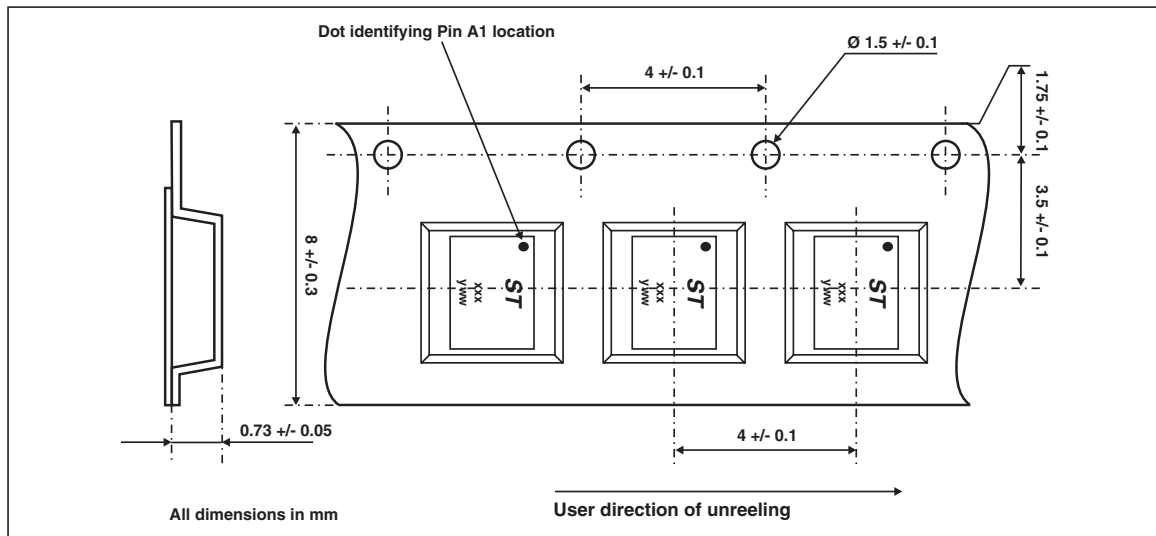


**MARKING**



## EMIF06-10006F1

### FLIP-CHIP TAPE AND REEL SPECIFICATION



### OTHER INFORMATION

Ordering code	Marking	Package	Weight	Base qty	Delivery mode
EMIF06-10006F1	FTT	Flip-Chip	5.4 mg	5000	Tape & reel

**Note:** More packing informations are available in the application note AN1235: "Flip-Chip: Package description and recommendations for use"

Information furnished is believed to be accurate and reliable. However, STMicroelectronics assumes no responsibility for the consequences of use of such information nor for any infringement of patents or other rights of third parties which may result from its use. No license is granted by implication or otherwise under any patent or patent rights of STMicroelectronics. Specifications mentioned in this publication are subject to change without notice. This publication supersedes and replaces all information previously supplied. STMicroelectronics products are not authorized for use as critical components in life support devices or systems without express written approval of STMicroelectronics.

The ST logo is a registered trademark of STMicroelectronics.

All other names are the property of their respective owners.

© 2004 STMicroelectronics - All rights reserved.

STMicroelectronics GROUP OF COMPANIES

Australia - Belgium - Brazil - Canada - China - Czech Republic - Finland - France - Germany -  
 Hong Kong - India - Israel - Italy - Japan - Malaysia - Malta - Morocco - Singapore - Spain -  
 Sweden - Switzerland - United Kingdom - United States

[www.st.com](http://www.st.com)