



SANYO Semiconductors

DATA SHEET

LA1837M — Monolithic Linear IC An ON Semiconductor Company Single-Chip AM/FM Tuner IC for Home Stereo Systems

Overview

The LA1837M is a single-chip AM/FM tuner IC that provides AM and FM IF and multiplex decoding circuits for electronic tuning and was developed for use in home stereo systems. It provides both SD and IF counting techniques for optimal implementation of automatic station selection.

Features

- On-chip MPX VCO circuit (no external components required).
- Adjacent channel interference rejection function (third order and fifth order).
- Supports both the SD and IF counting technique (built-in SD speedup function).
- The AM and FM SD sensitivity can be set independently.
- The AM and FM output levels can be set independently.
- Improved basic FM reception performance.

Functions

- AM: RF amplifier, mixer, oscillator, IF amplifier, detector, AGC, oscillator buffer, S-meter, narrow band SD, IF buffer
- FM IF: IF amplifier, quadrature detector, S-meter, SD, S curve detection, IF buffer output
- Multiplex stereo decoding: PLL stereo decoder, stereo indicator, forced monaural, VCO stop function, post amplifier, audio muting, adjacent channel interference rejection function

Specifications

Maximum Ratings at Ta = 25°C

| Parameter | Symbol | Conditions | Ratings | Unit |
|-----------------------------|---------------------|------------|-------------|------|
| Maximum supply voltage | V _{CC} max | | 12 | V |
| Allowable power dissipation | Pd max | Ta ≤ 70°C* | 550 | mW |
| Operating temperature | Topr | | -20 to +70 | °C |
| Storage temperature | Tstg | | -40 to +125 | °C |

*: Mounting board: 114.3×76.1×1.6mm glass epoxy board

■ Any and all SANYO Semiconductor products described or contained herein do not have specifications that can handle applications that require extremely high levels of reliability, such as life-support systems, aircraft's control systems, or other applications whose failure can be reasonably expected to result in serious physical and/or material damage. Consult with your SANYO Semiconductor representative nearest you before using any SANYO Semiconductor products described or contained herein in such applications.

■ SANYO Semiconductor assumes no responsibility for equipment failures that result from using products at values that exceed, even momentarily, rated values (such as maximum ratings, operating condition ranges, or other parameters) listed in products specifications of any and all SANYO Semiconductor products described or contained herein.

SANYO Semiconductor Co., Ltd.

<http://semicon.sanyo.com/en/network>

LA1837M

Operating Conditions at $T_a = 25^\circ\text{C}$

| Parameter | Symbol | Conditions | Ratings | Unit |
|--------------------------------|--------------------|------------|-------------|------|
| Recommended supply voltage | V_{CC} | | 9 | V |
| Operating supply voltage range | $V_{CC\text{ op}}$ | | 7.0 to 11.0 | V |

Electrical Characteristics at $T_a = 25^\circ\text{C}$ $V_{CC} = 9.0\text{V}$, in the specified circuit.

| Parameter | Symbol | Conditions | Ratings | | | Unit |
|---|---------------------|--|---------|------|------|----------|
| | | | min | typ | max | |
| [FM Mono Characteristics] $f_c = 10.7\text{MHz}$, $f_m = 1\text{kHz}$, with the coil adjusted so that $V_{AFC} - V_{REG} = 0\text{V}$. | | | | | | |
| Current drain | I_{CCO-FM} | No input | 18 | 31 | 44 | mA |
| Demodulator output | V_{OFM} | 100dB μ , 100% mod, pin 16 output | 730 | 1100 | 1460 | mVrms |
| Channel balance | C.B-mono | 100dB μ , 100% mod, pin 16 output / pin 17 output | -1.5 | 0 | +1.5 | dB |
| Total harmonic distortion (mono) | THDFM1 | 100dB μ , 100% mod, pin 16 output | | 0.3 | 1.3 | % |
| | THDFM2 | 100dB μ , 200% mod, pin 16 output | | 1.0 | 5.0 | % |
| Signal-to-noise ratio | S/N_{FM} | 100dB μ , 100% mod, pin 16 output | 72 | 80 | | dB |
| AM rejection ratio | AMR | 100dB μ , AM 30% mod, pin 16 output | 45 | 65 | | dB |
| Input limiting voltage | -3dBLS | Referenced to 100dB μ , 100% mod, the input for output is -3dB down. | 26 | 32 | 38 | dB μ |
| LED on sensitivity | SD_{ON-FM} | | 51 | 60 | 69 | dB μ |
| LED on bandwidth | SD_{BW} | 100dB μ | 85 | 120 | 170 | kHz |
| IF counter buffer output | $V_{IFBUFF-FM}$ | 100dB μ , pin 13 output | 80 | 120 | 160 | mVrms |
| S-meter output | $V_{SM\text{ FM}1}$ | 0dB μ , pin 11 output | 0 | 0.1 | 0.5 | V |
| | $V_{SM\text{ FM}2}$ | 100dB μ , pin 11 output | 3.6 | 4.3 | 5.0 | V |
| Muting attenuation | Mute Alt | 100dB μ , 100% mod, the pin 16 output | 75 | 85 | | dB |
| [FM Stereo Characteristics] $f_c = 10.7\text{MHz}$, 100dB μ , $f_m = 1\text{kHz}$, L+R = 90%, pilot = 10% | | | | | | |
| Separation: L | SepL | Lmod. pin 16 output / pin 17 output | 30 | 45 | | dB |
| Separation: R | SepR | Rmod. pin 17 output / pin 16 output | 30 | 45 | | dB |
| Stereo on level | ST_{ON} | The pilot mod such that $V_7 < 0.7\text{V}$ | 1.3 | 2.7 | 5.0 | % |
| Stereo off level | ST_{OFF} | The pilot mod such that $V_7 > 4.5\text{V}$ | | 1.5 | | % |
| Total harmonic distortion (main) | THD main | L+R mod. Pin 16 output | | 0.3 | 1.3 | % |
| Adjacent channel interference rejection ratio | Brej-3rd | $f_s = 113\text{kHz}$, $V_s = 90\%$, Pilot = 10% Pin 16 output, versus L-R mod. 1kHz demodulator output | | 40 | | dB |
| | Brej-5th | $f_s = 189\text{kHz}$, $V_s = 90\%$, Pilot = 10% Pin 16 output, versus L-R mod. 1kHz demodulator output | | 40 | | dB |
| [AM Characteristics] | | | | | | |
| Current drain | I_{CCO-AM} | No input | 15 | 25 | 35 | mA |
| Output detector | V_{OAM1} | 23dB μ , 30% mod, pin 16 output | 100 | 180 | 360 | mVrms |
| | V_{OAM2} | 80dB μ , 30% mod, pin 16 output | 200 | 320 | 500 | mVrms |
| Signal-to-noise ratio | S/N_{AM1} | 23dB μ , 30% mod, pin 16 output | 18 | 22 | | dB |
| | S/N_{AM2} | 80dB μ , 30% mod, pin 16 output | 49 | 55 | | dB |
| Total harmonic distortion | THD AM 1 | 80dB μ , 30% mod, pin 16 output | | 0.4 | 1.2 | % |
| | THD AM 2 | 80dB μ , 80% mod, pin 16 output | | 1.0 | 4.0 | % |
| LED-ON sensitivity | SD_{ON-AM} | | 17 | 27 | 37 | dB μ |
| Oscillator buffer output | V_{OSC-AM} | No input, pin 30 output | 110 | 160 | 220 | mVrms |
| IF counter buffer output | $V_{IFBuff-AM}$ | 80dB μ , non-mod, pin 13 output | 160 | 220 | 300 | mVrms |
| ST IF output | $V_{STIF-AM}$ | 80dB μ , non-mod, pin 7 output | 16 | 34 | 48 | mVrms |
| S-meter output | V_{SM-AM} | 0dB μ , non-mod | 0 | 0 | 0.2 | V |

LA1837M

Package Dimensions

unit : mm
3073C

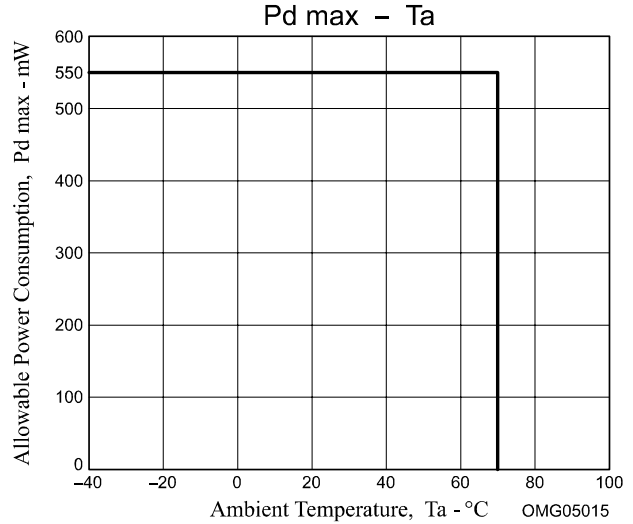
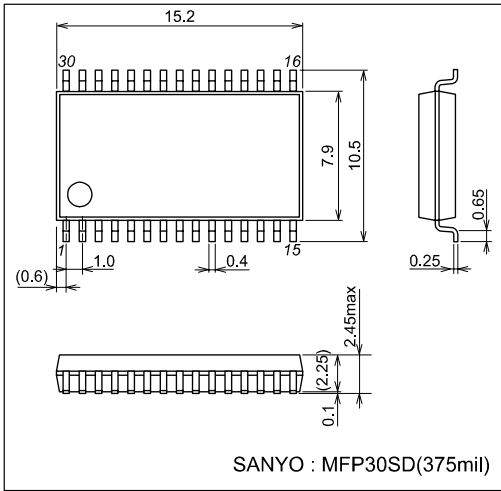

Block Diagram

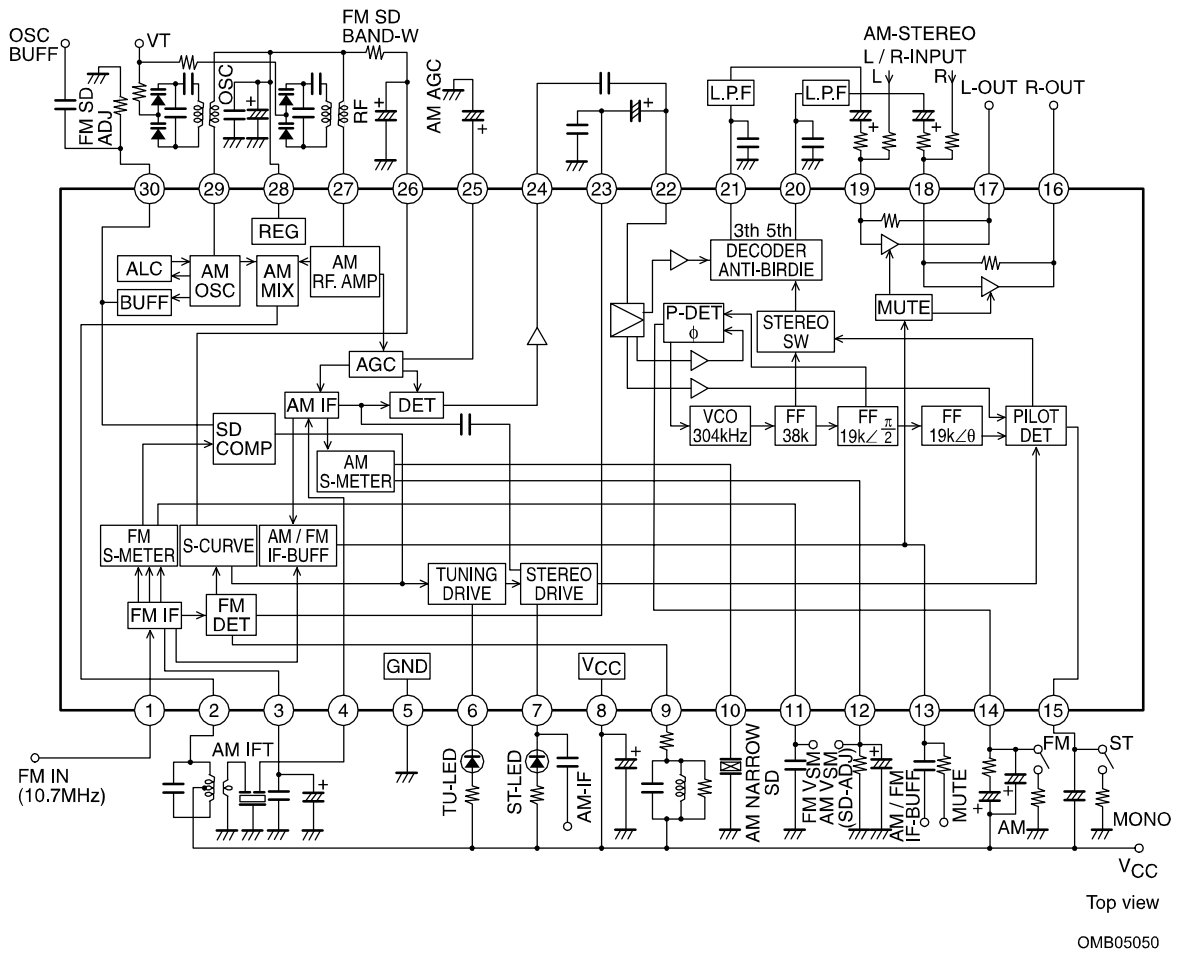

Coil Specifications

- AM oscillator (for the DUT)
HW-50425 (Mitsumi Electric Co., Ltd.)

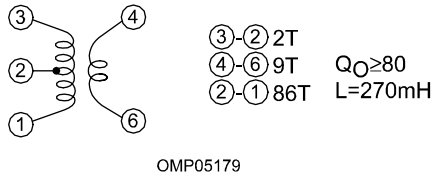

- IFT
YD-1073-1 (Mitsumi Electric Co., Ltd.)

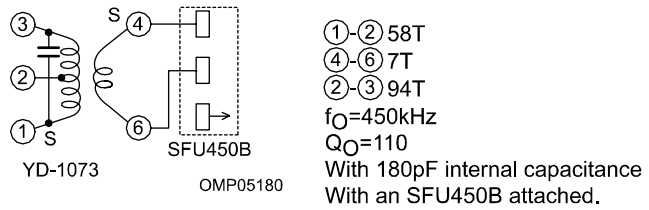

- FM-DET
600BEAS-9715Z (Toko Electric Corporation)

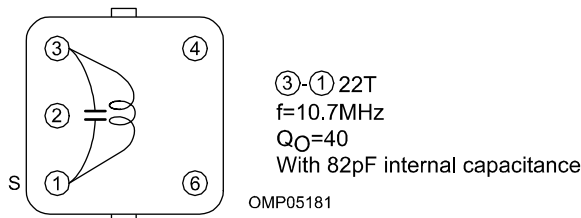

Pin Function

| Pin No. | Pin | Pin voltage | Equivalent circuit | Pin function |
|---------|--------------------------------------|-------------|--------------------|--|
| 1 | FM IF input | Vreg | OMP05156 | Input impedance $r_i = 330 \Omega$ |
| 2 | AM mixer output | VCC | OMP05157 | Connect the mixer coil between this pin and VCC. |
| 3 | FM IF input bypass | Vreg | See pin 1 | Also used for the multiplex regulator filter |
| 4 | AM IF input | Vreg | OMP05158 | Input impedance $r_i = 2 \text{ k}\Omega$ |
| 5 | GND | 0V | | |
| 6 | TU-LED, ST-LED, AM - IF output | VCC VCC | OMP05159 | Active low Open collector AM stereo IF output (pin 7) This pin must be set up with an influx current under 150μA. |
| 8 | | VCC | | |
| 9 | FM detector | VCC | OMP05160 | Recommended detector coil 600BEAS-9715Z (The Toko Electric Corporation) |

Continued on next page.

LA1837M

Continued from preceding page.

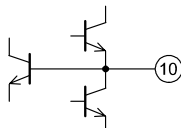
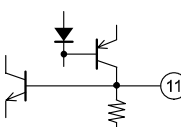
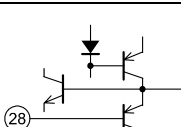
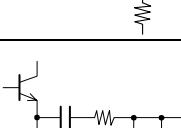
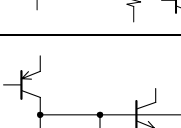
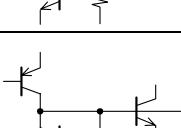
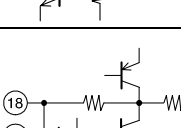
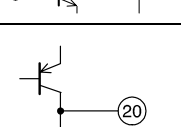
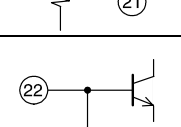
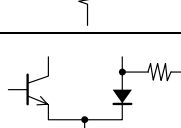
| Pin No. | Pin | Pin voltage | Equivalent circuit | Pin function |
|----------------------|---|------------------------------|---|--|
| 10 | AM narrow band ceramic filter connection | 1.3V |  OMP05161 | Recommended narrow band ceramic filter BFU450C4N (Murata Mfg. Co., Ltd.) When the narrow band SD function is not used, bypass this circuit by connecting a 50Ω resistor and a 0.047μF capacitor in series. |
| 11 | FM S-meter output | 0V |  OMP05162 | $R_L = 8k\Omega$ |
| 12 | AM S-meter output, AM SD sensitivity adjustment | 0V (AM) |  OMP05163 | The AM SD sensitivity can be adjusted with an external resistor between this pin and ground. |
| 13 | AM/FM IF buffer output, Output control switch (muting switch) | 0V |  OMP05164 | $V_{13} \leq 0.5V$: Reception state $1.4V \leq V_{13} \leq 2.2V$: IF buffer output on $V_{13} \geq 3.5V$: IF buffer output and muting on |
| 14 | Phase comparator low-pass filter (FM/AM switching) | $V_{CC}-1.4$ (FM) 0V (AM) |  OMP05166 | The IC switches to AM mode when this pin is connected to ground through a resistor. Resistor value limits: 2.7kΩ (when $V_{CC} = 7V$) 3.9kΩ (8V) 5.1kΩ (9V) 6.2kΩ (10V) 7.5kΩ (11V) |
| 15 | Pilot detector low-pass filter (Forced monaural) (VCO stop) | $V_{CC}-1.0$ |  OMP05167 | When a current of over 50μA is sourced by this pin, the IC switches to forced monaural mode. The VCO is stopped if this pin is connected to ground. The resistor value limits are the same as for pin 14. |
| 16 17 18 19 | Post amplifier I/O | Verg Verg |  OMP05168 | Output impedance $r_O = 200\Omega$ Pin 16: right output, pin 17: left output Inverting input pins Pin 18: right input, pin 19: left input $R_{NF} = 33k\Omega$ |
| 20 21 | Multiplex output | 3.5V 3.5V |  OMP05169 | Output impedance $r_O = 3.3k\Omega$ Pin 20: Right channel deemphasis Pin 21: Left channel deemphasis |
| 22 | Multiplex input | 2.9V |  OMP05170 | Input impedance $r_i = 20k\Omega$ |
| 23 | FM demodulated output | 2.8V (FM) 2.8V (AM) |  OMP05171 | Output impedance $r_O = 3.0k\Omega$ The separation can be adjusted with an external capacitor connected between this pin and ground. The V_{Osub}/V_{Omain} ratio is set to be approximately 0dB. |

Continued on next page.

LA1837M

Continued from preceding page.

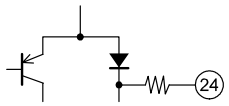
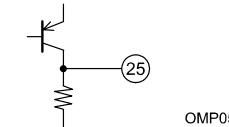
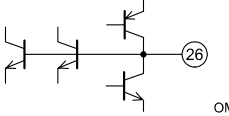
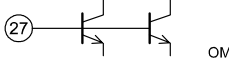
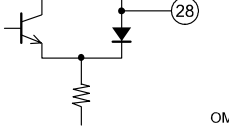
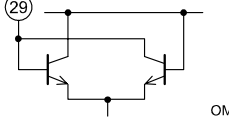
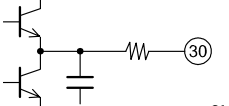
| Pin No. | Pin | Pin voltage | Equivalent circuit | Pin function |
|---------|--|------------------------|---|--|
| 24 | AM detector output | 0V (FM) 0.5V (AM) |  OMP05172 | Output impedance $r_o = 3.3k\Omega$ The AM frequency characteristics can be adjusted with an RC circuit connected between pin 22 and ground. |
| 25 | AM AGC | 0V (FM) 0.5V (AM) |  OMP05173 | Internal load resistance $R = 11k\Omega$ |
| 26 | AFC | Vreg |  OMP05174 | The FM SD bandwidth can be adjusted with an external resistor connected between this pin and pin 28. |
| 27 | AM RF input | Vreg |  OMP05175 | This pin must be held at the same potential as pin 28 |
| 28 | REG | Vreg |  OMP05176 | Vreg = 3.6V |
| 29 | OSC | Vreg |  OMP05177 | Connect the oscillator coil between this pin and pin 28. |
| 30 | Oscillator buffer output, FM SD sensitivity adjustment | 1.6V (FM) 1.3V (AM) |  OMP05177 | The FM SD sensitivity can be adjusted with an external resistor connected between this pin and ground. Output impedance $r_o = 20\Omega$ |

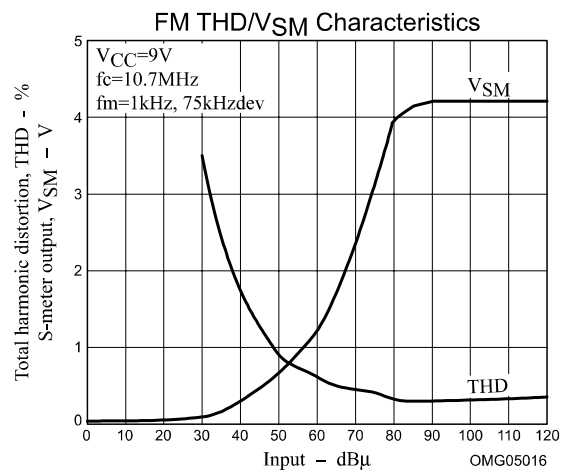
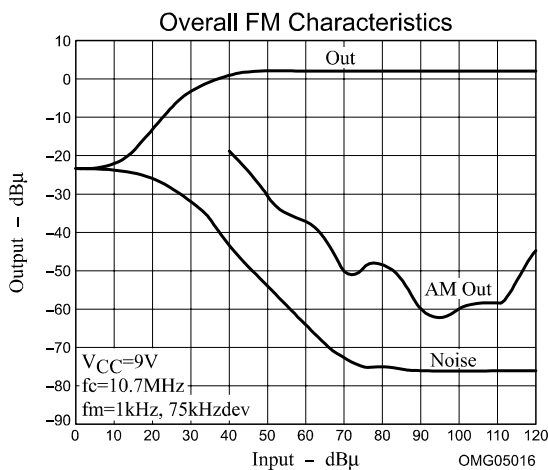

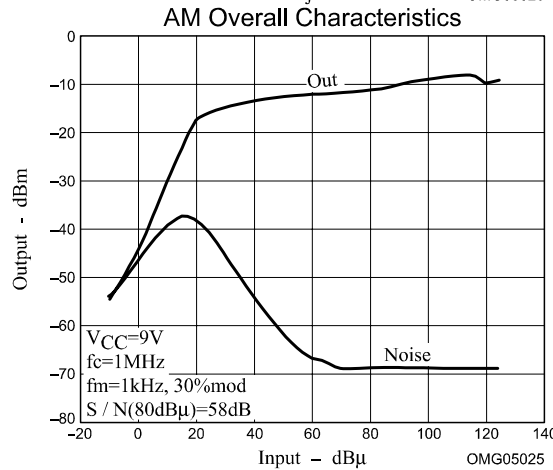
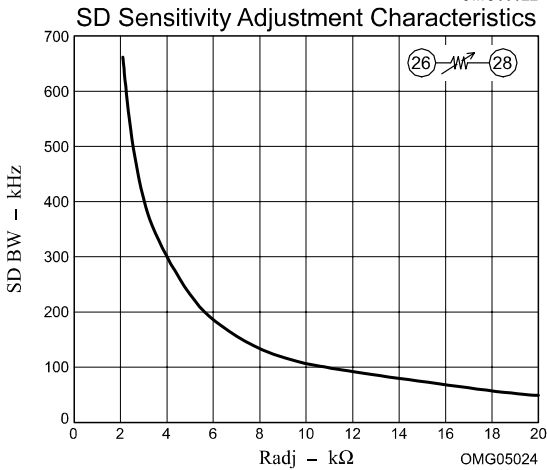
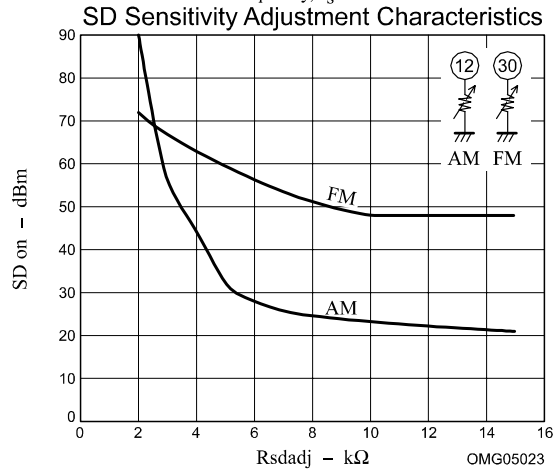
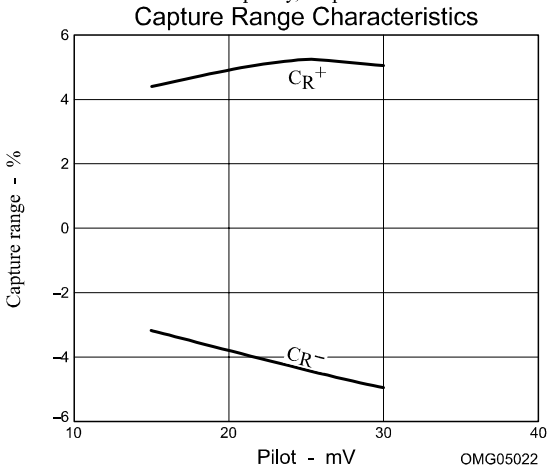
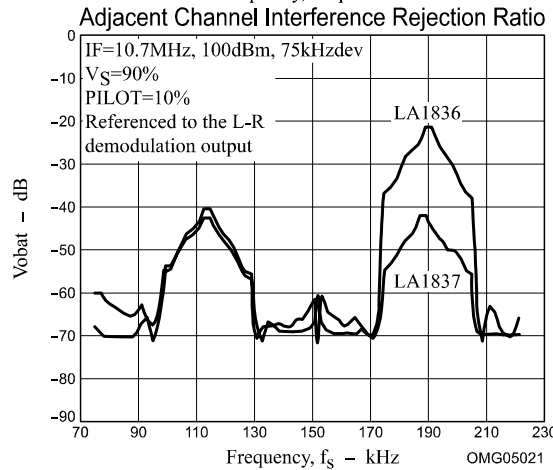
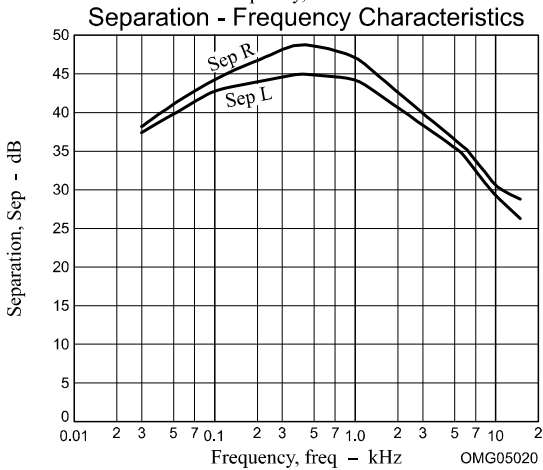
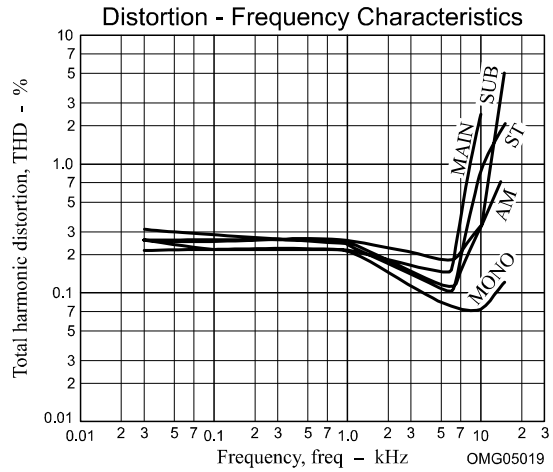
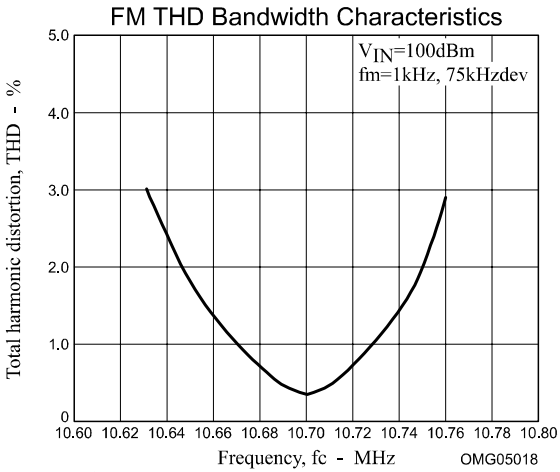

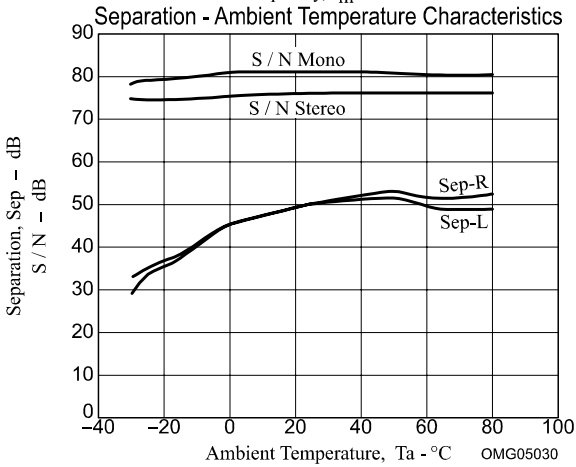
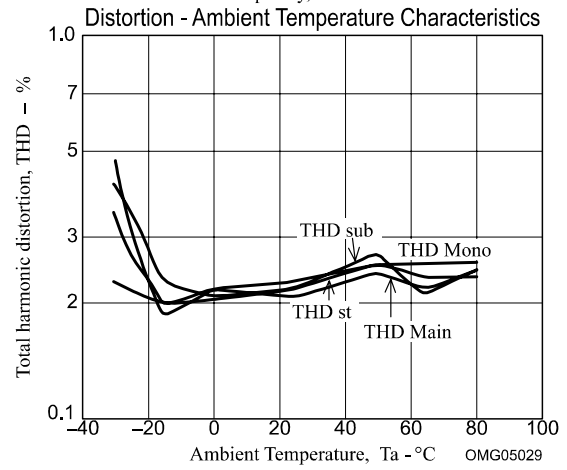
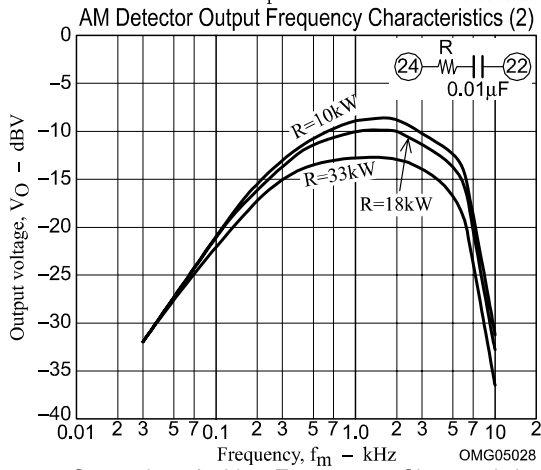
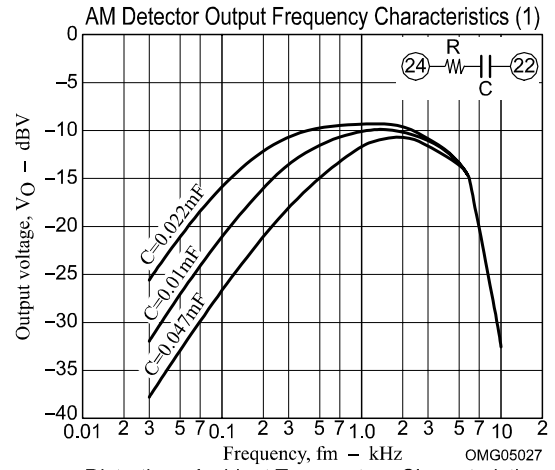
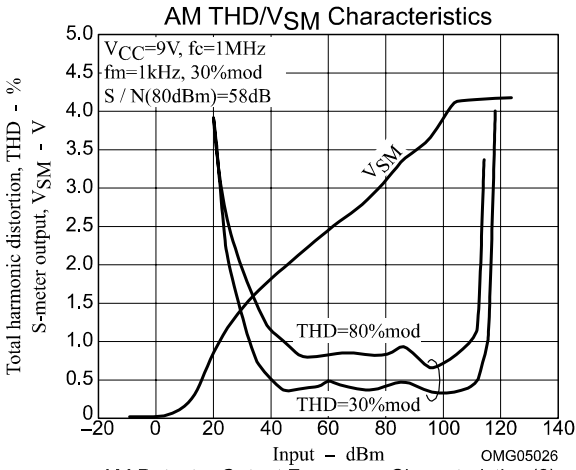

LA1837M

Test Circuit

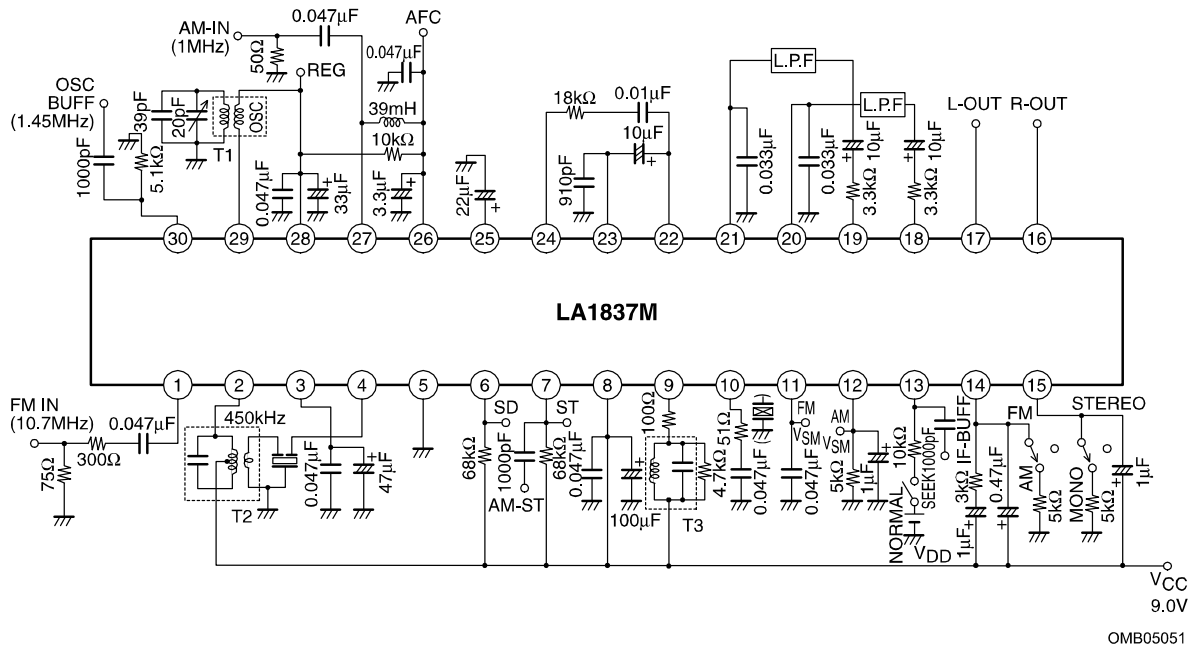

- Specifications of any and all SANYO Semiconductor products described or contained herein stipulate the performance, characteristics, and functions of the described products in the independent state, and are not guarantees of the performance, characteristics, and functions of the described products as mounted in the customer's products or equipment. To verify symptoms and states that cannot be evaluated in an independent device, the customer should always evaluate and test devices mounted in the customer's products or equipment.
- SANYO Semiconductor Co., Ltd. strives to supply high-quality high-reliability products. However, any and all semiconductor products fail with some probability. It is possible that these probabilistic failures could give rise to accidents or events that could endanger human lives, that could give rise to smoke or fire, or that could cause damage to other property. When designing equipment, adopt safety measures so that these kinds of accidents or events cannot occur. Such measures include but are not limited to protective circuits and error prevention circuits for safe design, redundant design, and structural design.
- In the event that any or all SANYO Semiconductor products (including technical data, services) described or contained herein are controlled under any of applicable local export control laws and regulations, such products must not be exported without obtaining the export license from the authorities concerned in accordance with the above law.
- No part of this publication may be reproduced or transmitted in any form or by any means, electronic or mechanical, including photocopying and recording, or any information storage or retrieval system, or otherwise, without the prior written permission of SANYO Semiconductor Co., Ltd.
- Any and all information described or contained herein are subject to change without notice due to product/technology improvement, etc. When designing equipment, refer to the "Delivery Specification" for the SANYO Semiconductor product that you intend to use.
- Information (including circuit diagrams and circuit parameters) herein is for example only; it is not guaranteed for volume production. SANYO Semiconductor believes information herein is accurate and reliable, but no guarantees are made or implied regarding its use or any infringements of intellectual property rights or other rights of third parties.

This catalog provides information as of October, 2005. Specifications and information herein are subject to change without notice.