

RoHS Compliant & Pb-Free Product

- Typical Applications
- WLAN LNA with Bypass Feature
 - CDMA PCS LNA with Bypass Feature
 - MMDS LNA with Bypass Feature
 - General Purpose Amplification
 - Commercial and Consumer Systems

Product Description

The RF2370 is a switchable low noise amplifier with a very high dynamic range designed for digital cellular and WLAN applications. The device functions as an outstanding front end low noise amplifier. The bias current may be set externally. The IC is featured in a standard SOT 6-lead plastic package.

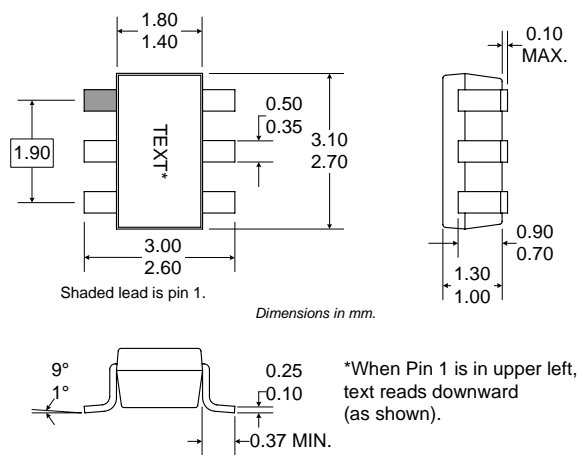

Optimum Technology Matching® Applied

- | | | |
|-------------------------------------|--|---------------------------------------|
| <input type="checkbox"/> Si BJT | <input checked="" type="checkbox"/> GaAs HBT | <input type="checkbox"/> GaAs MESFET |
| <input type="checkbox"/> Si Bi-CMOS | <input type="checkbox"/> SiGe HBT | <input type="checkbox"/> Si CMOS |
| <input type="checkbox"/> InGaP/HBT | <input type="checkbox"/> GaN HEMT | <input type="checkbox"/> SiGe Bi-CMOS |

Package Style: SOT 6-Lead

- Features
- Low Noise and High Intercept Point
 - Adjustable Bias Current
 - Power Down Control
 - Low Insertion Loss Bypass Feature
 - 1.8V to 5V Operation (See Note: Page 2)
 - 1.5GHz to 3.8GHz Operation

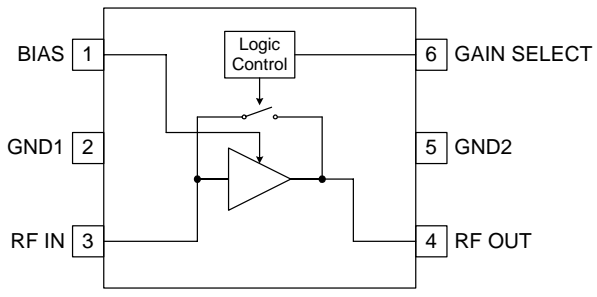

Functional Block Diagram

Ordering Information

RF2370 3V Low Noise Amplifier
 RF2370PCBA-410 Fully Assembled Evaluation Board (WLAN) usable from 1.9GHz to 4GHz with standard tune

RF Micro Devices, Inc.
 7628 Thorndike Road
 Greensboro, NC 27409, USA

Tel (336) 664 1233
 Fax (336) 664 0454
 http://www.rfmd.com

RF2370

Absolute Maximum Ratings

Parameter	Rating	Unit
Supply Voltage	-0.5 to +6.0	V _{DC}
Input RF Level	+5 (see note)	dBm
Current Drain, I _{CC}	32	mA
Operating Ambient Temperature	-40 to +85	°C
Storage Temperature	-40 to +150	°C



Caution! ESD sensitive device.

RF Micro Devices believes the furnished information is correct and accurate at the time of this printing. RoHS marking based on EU Directive 2002/95/EC (at time of this printing). However, RF Micro Devices reserves the right to make changes to its products without notice. RF Micro Devices does not assume responsibility for the use of the described product(s).

NOTE: Exceeding any one or a combination of the above maximum rating limits may cause permanent damage. Input RF transients to +15dBm will not harm the device. For sustained operation at inputs $\geq +5$ dBm, a small dropping resistor is recommended in series with the V_{CC} in order to limit the current due to self-biasing to <32mA.

Parameter	Specification			Unit	Condition
	Min.	Typ.	Max.		
Operating Range					T _{AMB} =+25°C, V _{CC} =3.0V
Frequency Range	900		4000	MHz	
WLAN Low Noise Amplifier					
Frequency		2450		MHz	
<i>HIGH GAIN MODE</i>					Gain Select<0.8V, V _{BIAS} =3V, T=+25°C
Gain	12.0	14.0		dB	
Noise Figure		1.3	1.5	dB	
Input IP3		+7.0		dBm	IIP3 will improve if ICC is raised above 7mA.
Output VSWR		1.7:1	2:1		
Current Drain		7		mA	
<i>BYPASS MODE</i>					Gain Select>1.8V, V _{BIAS} =0V
Gain	-4.0	-3.0	-2.0	dB	Note: Bypass mode insertion loss will degrade gradually as V _{CC} goes below 2.7V.
Input IP3	+16.0	+20.0		dBm	
Output VSWR		1.6:1			
Current Drain		2.0	3.0	mA	
Power Supply					
Voltage (V _{CC})		3		V	
V _{SELECT} Low			0.8	V	High Gain mode. Select<0.8V, V _{BIAS} =3V
V _{SELECT} High	1.8			V	Low Gain mode. Select>1.8V, V _{BIAS} =0V
Power Down	0		10	μA	Gain Select<0.8V, V _{BIAS} =0V, V _{CC} =0V

Bias note: Due to the presence of ESD protection circuitry on the RF2370, the maximum allowable collector bias voltage (pin 4) is 4.0V. Higher supply voltages such as 5V are permissible if a series resistor is used to drop V_{CC} to ≤ 4.0 V for a given I_{CC}.

Pin	Function	Description	Interface Schematic
1	BIAS	For low noise amplifier applications, this pin is used to control the bias current. An external resistor can be used to set the bias current for any V_{BIAS} voltage.	
2	GND1	Ground connection. For best performance, keep traces physically short and connect immediately to ground plane.	
3	RF IN	RF input pin. This part is designed such that 50Ω is the optimal source impedance for best noise figure. Best noise figure is achieved with only a series capacitor on the input.	
4	RF OUT	Amplifier output pin. This pin is an open-collector output. It must be biased to V_{CC} through a choke or matching inductor. This pin is matched to 50Ω with a shunt L, series L topology enhances to stability of the device by reducing the high frequency gain above 6GHz.	
5	GND2	See GND1.	
6	GAIN SELECT	This pin selects high gain and bypass modes. Gain Select $\leq 0.8V$, high gain. Gain Select $\geq 1.8V$, low gain. A series resistor of 100Ω is required on this pin to enhance stability.	

RF2370

Evaluation Board Schematic

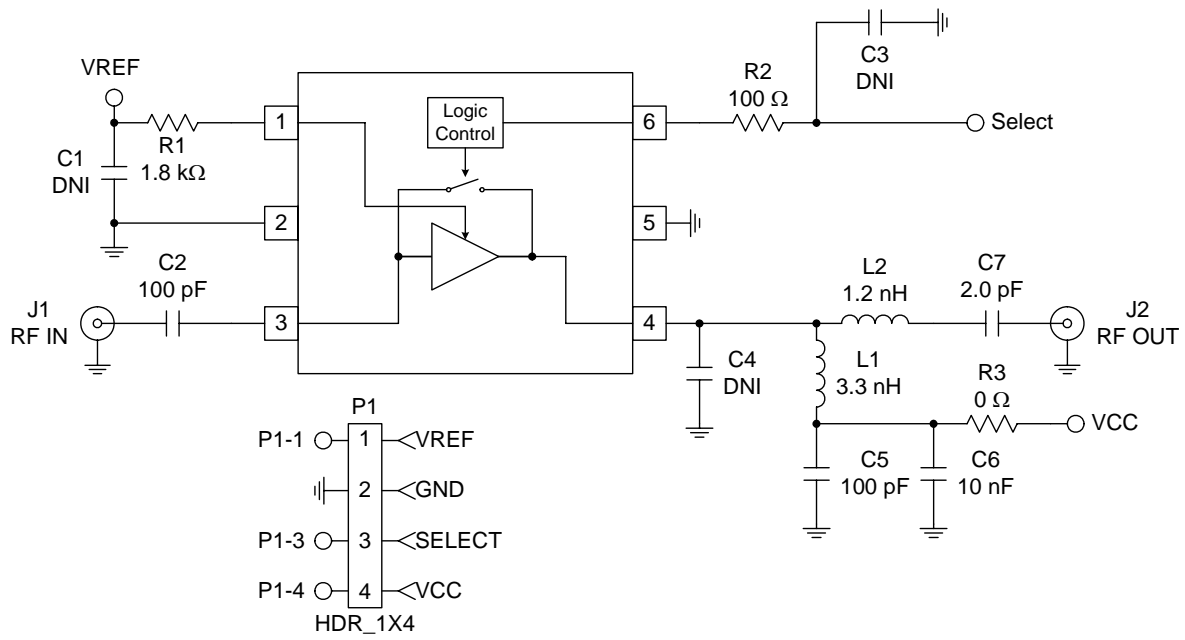

Evaluation Board Layout

Board Size 0.835" x 0.900"
Board Thickness 0.032", Board Material FR-4

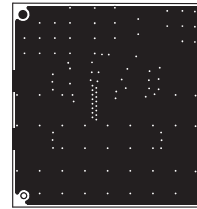
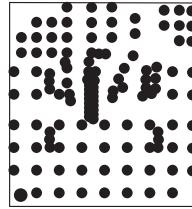
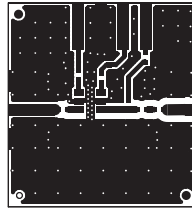
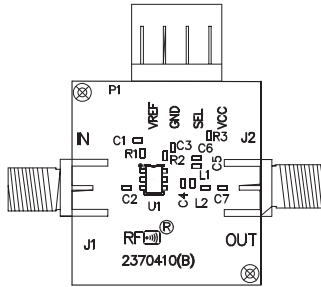

RF2370