

0.8 – 2.5 GHz Upconverter/Amplifier

Technical Data

HPMX-2006

Features

- **Wide Band Operation**
RF Output: 800-2500 MHz
IF Input: DC-900 MHz
- **2.7-5.5 V Operation**
- **Mixer + Amplifier:** 38 mA
Mixer only: 15 mA
Standby Mode: $40 \mu\text{A}$
- **Differential LO and High Impedance IF Inputs**
- **-8.5 dBm Mixer and +4.5 dBm Amplifier Output Power at 1900 MHz**
- **JEDEC Standard SSOP-16 Surface Mount Package**

Applications

- **Cordless Handsets and Base Stations**
- **Wireless Data Terminals**
- **Cellular/PCS Handsets and Base Stations**

Functional Block Diagram

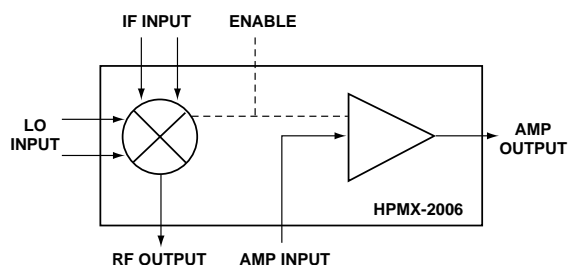

Package Pin Configuration

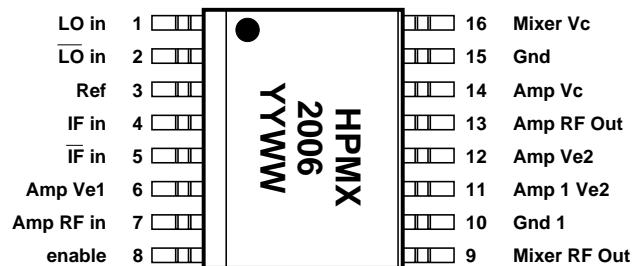

Plastic SSOP-16

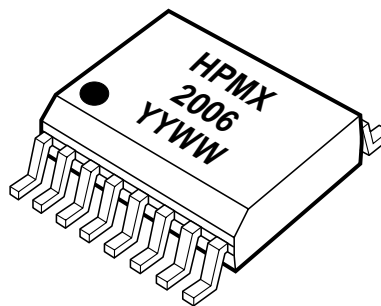

Description

The HPMX-2006 upconverter/amplifier IC is designed to meet the needs of cellular and PCS telephone and wireless LAN applications.

The IC consists of a Gilbert Cell mixer optimized for upconversion followed by a post-amplifier. The mixer and amplifier are independent allowing the insertion of a sideband filter between the two.

The mixer is double balanced. Both LO and IF inputs may be run either single-endedly, or in differential mode to reduce LO leakage. LO inputs are matched near 50 Ω ; high impedance IF inputs allow the mixer to be used as a BPSK modulator. An integrated transformer on the mixer RF port creates a single-ended, matched to 50 Ω output at 1900 MHz, and also reduces common mode noise.

The amplifier features a single-ended 50 Ω match on the input port. The open collector output is easily matched with a simple 2 element network, providing flexible use and good power added efficiency. The amplifier can be disabled to allow use of the mixer alone, reducing the current

draw to around 15 mA. The entire IC can be put into a standby mode reducing current consumption to under 40 μA from a 3V source.

The SSOP-16 package insures that the IC occupies a minimal amount of printed circuit board space.

The HPMX-2006 is manufactured using Hewlett-Packard's 30 GHz ISOSAT-II process which combines stepper lithography, self alignment, ion implantation techniques and gold metalization to produce state-of-the-art RFICs.

HPMX-2006 Absolute Maximum Ratings^[1]

Symbol	Parameter	Units	Mixer		Amplifier	
			Min.	Max.	Min.	Max.
V _{CC}	Supply Voltage	V	-0.2	8	-0.2	8
P _{diss}	Power Dissipation ^[2,3]	mW		174		274
	Single-Ended Input Mixer LO Voltage	V		V _C + 0.2		
	Single-Ended Input Mixer IF Voltage	V		V _C + 0.2		
	Amplifier Input RF Power	dBm				+5
T _j	Junction Temperature	°C	-40	+150	-40	+150
T _{STG}	Storage Temperature	°C	-40	+150	-40	+150

Notes:

1. Operation of this device in excess of any of these parameters may cause permanent damage.
2. T_{CASE} = 25°C
3. Derate at 7 mW/°C for T_{CASE} > 82°C.

Thermal Resistance^[2]:

$$\theta_{jc} = 150^{\circ}\text{C}/\text{W}$$

Recommended operating range of V_{CC} = 2.7 to 5.5 V, T_a = -40 to + 85°C

Standard Test Conditions

Unless otherwise stated, all test data was taken on packaged parts under the following conditions:

V_{CC} = +3.0 VDC, Z_{out} = 50 Ω, ambient temperature T_a = 25°C

LO input: 1750 MHz, -3 dBm, single-ended

IF input: 150 MHz, 300 mV_{p-p}, single-ended, terminated in a 50 Ω pull-up resistor (R1R2 in Figure 11)

Z_{out mixer} = Z_{in amp} = 50 Ω, Z_{out amp} per Figure 11 (L=2.8 nH, C=2.2 pF)

See Figure 11 for test set-up schematic diagram.

HPMX-2006 Guaranteed Electrical Specifications

Standard test conditions apply unless otherwise noted.

Symbol	Parameters and Test Conditions	Units	Min.	Typ.	Max.
I _{C mix}	Sleep Mode Current, Mixer	μA			20
I _{C amp}	Sleep Mode Current, Amplifier	μA			20
I _{C mix}	Mixer Transmit Current	mA		15	18
I _{C amp}	Amplifier Transmit Current	mA		23	28
P _{out}	SSB Output Power, Mixer Only	dBm	-11	-9	
P _{out}	Output Power, Amplifier Only (-9.5 dBm in)	dBm	+25	+38	

HPMX-2006 Summary Characterization Information

Standard test conditions apply unless otherwise noted. Table 2 applies for 900 and 2500 MHz. IF remains 150 MHz for all frequencies.

Performance vs. Frequency	900 MHz	1900 MHz	2500 MHz	Units
Mixer RF Output Power, $V_{if} = 300 \text{ mV}_{pp}$	-8	-9	-12.5	dBm
Mixer RF Output Power, $V_{if} = 30 \text{ mV}_{pp}$	-28	-28	-32	dBm
Mixer RF Output Power at 1 dB Gain Compression	-7	-8.5	-12	dBm
Mixer Output Third Order Intercept Point	+3	+2	-4	dBm
Mixer LO Suppression	25	21	18.5	dBc
Mixer Phase Noise (4 MHz offset)	-143	-144	-146	dBm/Hz
Amplifier RF Output Power at $P_{in} = -9.5 \text{ dBm}$	+9	+38	-2	dBm
Amplifier RF Output Power at 1 dB Gain Compression	+9	+45	+25	dBm
Amplifier Output Third Order Intercept Point	+19	+14	+12	dBm
Small Signal Amplifier Gain	21	14.5	9.5	dB
Amplifier Noise Figure	8.5	9	9.5	dB
Amplifier Input Return Loss	10.5	9.5	10.5	dB
Amplifier Output Return Loss	9.5	6.5	12	dB
Isolation, Mixer Output to Amplifier Input	32	30	30	dB

HPMX-2006 Pin Description Table

No.	Mnemonic	Description	Typical Signal	Notes
1	LO	differential mixer LO input	-3 dBm from single-ended, 50 Ω source	LO identical to LObar.
2	LObar			DC present (needs Cbl).
3	Ref	internal voltage reference		Supplies base bias for AC-coupled IF.
4	IF	differential mixer IF input	-6 dBm from single-ended, 50 Ω source	IF identical to IFbar.
5	IFbar			Must bias per Table 3.
6	AmpVe1	ground	0 V or unconnected	Disconnect for mixer only
7	AmpRFIn	amplifier input	-9.5 dBm from 50 Ω source	DC present (needs Cbl)
8	Enable	chip (amp and mixer) enable input	<0.4V disables >2.5V enables IC	
9	MxRFout	mixer RF output	-9.0 dBm into 50 Ω load	At DC ground
10	gnd1	ground	0 V	
11	Amp1Ve2	ground	0 V or unconnected	Disconnect for mixer only
12	AmpVe2	ground	0 V or unconnected	Disconnect for mixer only
13	AmpRFout	amplifier output	+3 dBm into 50 Ω load	DC present (needs Cbl). RF match required.
14	AmpVc	amplifier Vcc input	3 V, 23 mA	
15	gnd	ground	0 V	
16	MxVc	mixer Vcc input	3 V, 15 mA	

HPMX-2006 Typical Performance

Standard test conditions apply unless otherwise noted.

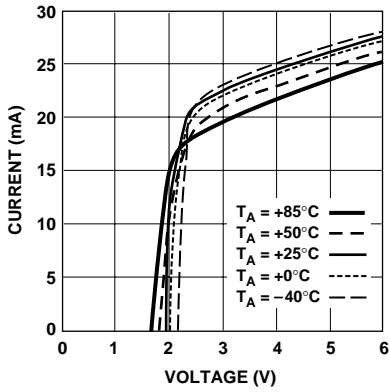

Figure 1. Mixer Device Current vs. Device Voltage over Temperature.

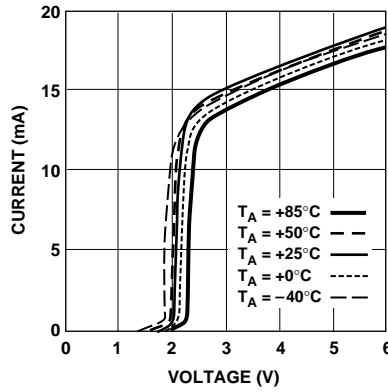

Figure 2. Mixer Device Current vs. Device Voltage over Temperature.

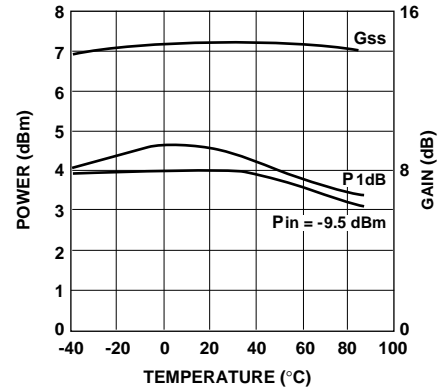

Figure 3. Amp. Output at $P_{in} = 9.5$ dBm and at 1 dB Compression and Small Signal Gain vs. Temperature.

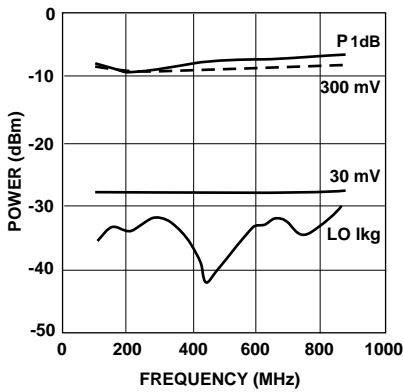

Figure 4. Mixer Output at $V_{if} = 30$ mV_{pp} and 300 mV_{pp}, at P_{1dB}, and LO Suppression at $V_{if} = 300$ mV_{pp} vs. IF Frequency.

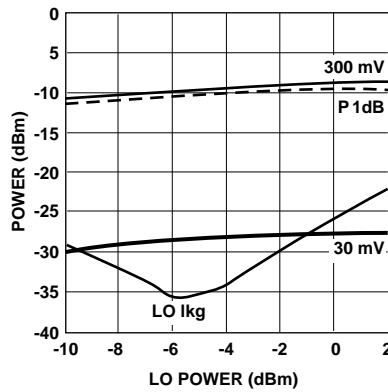

Figure 5. Mixer Output at $V_{if} = 30$ mV_{pp} and 300 mV_{pp}, at P_{1dB}, and LO Suppression at $V_{if} = 300$ mV_{pp} vs. LO Power.

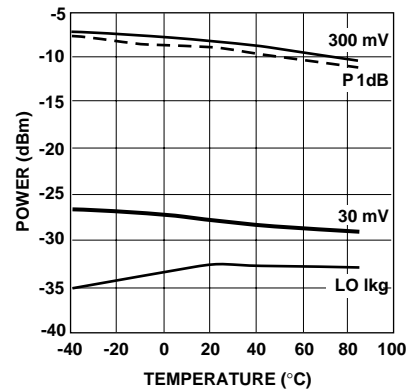

Figure 6. Mixer Output at $V_{if} = 30$ mV_{pp} and 300 mV_{pp}, at P_{1dB}, and LO Suppression at $V_{if} = 300$ mV_{pp} vs. Temperature.

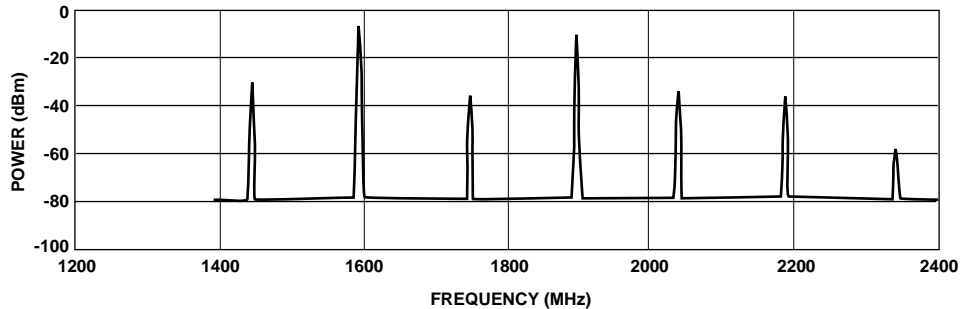

Figure 7. Mixer Output Spectrum for 1 GHz Bandwidth, Centered at 1900 MHz.

Table 1. Typical Output Spurs for 0 – 6 GHz, Standard Test Conditions.

	-10	-9	-8	-7	-6	-5	-4	-3	-2	-1	0	1	2	3	4	5	6	7	8	9	10
0											-	-38.9	-32.2	-44.1	-49.3	-67.2	-64.4	<-80	-73.6	<-80	<-80
1	<-80	<-80	<-80	-70	-78.5	-52.1	-58.8	-33.2	-38.9	-10.1	-31.7	-8.7	-38.3	-38.3	-59.0	-50.1	-39.2	-50.1	-50.2	<-60	<-60
2	<-80	<-60	<-60	<-60	<-60	<-60	-49.5	-50.0	-33.2	-39.1	-42.1	-50.4	-36.1	-48.8	-58.8	<-60	<-60	<-60	<-60	<-60	<-60
3	<-60	<-60	-38.4	-58.6	<-60	<-60	<-60	-52.7	<-60	<-60	-45.6	-37.1	-52	<-60	<-60						
4	<-60	-45.5	-52.0	<-60																	

HPMX-2006 Mixer Port Impedances

GHz	Mag.	Deg.
0.05	0.86	-4
0.10	0.81	-3
0.15	0.84	-1
0.20	0.88	-3
0.25	0.93	-9
0.30	0.91	-15
0.40	0.80	-19
0.50	0.81	-23
0.60	0.80	-28
0.70	0.80	-30
0.80	0.85	-34
0.90	0.84	-39

Figure 8. Impedance of Mixer IF Port.

Circuit of Figure 11 with 1 k Pull up Resistors for the IFs and LO and RF Ports Terminated in 50 Ω.

GHz	Mag.	Deg.
0.50 ^[1]	0.49	-49
0.75	0.48	-63
1.00	0.46	-73
1.25	0.42	-82
1.50	0.40	-102
1.75	0.31	-114
1.75 ^[2]	0.24	-131
2.00	0.20	147
2.25	0.20	87
2.50	0.16	15
2.75	0.37	-131
3.00	0.53	168

Figure 9. Impedance of Mixer LO Port.

- [1] Circuit of Figure 11 with IF and RF Ports Terminated in 50 Ω.
 [2] As above but LO RC combination in Figure 11 changed from 12 Ω and 12 pF to 0 Ω and 2.7 pF (recommended use for > 1.75 GHz).

GHz	Mag.	Deg.
0.50	0.60	82
0.75	0.55	38
1.00	0.52	-5
1.25	0.36	-35
1.50	0.18	-44
1.75	0.17	-17
2.00	0.20	5
2.25	0.24	13
2.50	0.28	17
2.75	0.34	12
3.00	0.37	3

Figure 10. Impedance of Mixer RF Port.

Circuit of Figure 11 with IF and LO Ports Terminated in 50 Ω.

Typical Scattering Parameters, Common Emitter, $Z_0 = 50 \Omega$, $V_{CC} = 3V$, $I_C = 23mA$

Freq. GHz	S_{11}		S_{21}			S_{12}			S_{22}	
	Mag.	Ang.	dB	Mag.	Ang.	dB	Mag.	Ang.	Mag.	Ang.
0.1	0.51	149	19.72	9.68	-26	-37.08	0.014	-43	0.91	-3
0.5	0.37	144	17.42	7.43	-49	-39.17	0.011	11	0.78	-16
0.8	0.37	120	16.56	6.73	-76	-43.10	0.007	1	0.80	-22
0.9	0.37	113	16.24	6.49	-85	-36.48	0.015	25	0.83	-23
1.0	0.39	104	15.99	6.30	-94	-40.00	0.010	22	0.84	-26
1.1	0.39	96	15.55	5.99	-101	-41.94	0.008	28	0.84	-29
1.2	0.40	88	15.16	5.73	-112	-47.96	0.004	118	0.84	-32
1.3	0.41	81	15.07	5.67	-120	-38.42	0.012	68	0.85	-33
1.4	0.40	75	14.50	5.31	-125	-40.92	0.009	85	0.87	-36
1.5	0.40	67	13.37	4.66	-134	-46.02	0.005	147	0.84	-40
1.6	0.38	62	12.69	4.31	-145	-33.98	0.020	99	0.85	-40
1.7	0.37	61	12.46	4.20	-148	-33.15	0.022	102	0.84	-44
1.8	0.36	58	11.64	3.82	-153	-32.77	0.023	102	0.84	-49
1.9	0.33	62	11.17	3.62	-161	-34.42	0.019	88	0.79	-51
2.0	0.33	62	10.81	3.47	-168	-34.89	0.018	91	0.77	-54
2.1	0.31	64	9.99	3.16	-175	-29.37	0.034	96	0.75	-58
2.2	0.31	70	9.37	2.94	178	-30.75	0.029	102	0.72	-62
2.3	0.30	75	8.66	2.71	173	-30.75	0.029	89	0.69	-65
2.4	0.32	79	8.10	2.54	170	-33.15	0.022	90	0.67	-70
2.5	0.32	84	7.16	2.28	166	-32.77	0.023	89	0.65	-76
3.0	0.32	94	4.45	1.67	134	-28.40	0.038	99	0.49	-103

HPMX-2006 Test Circuit

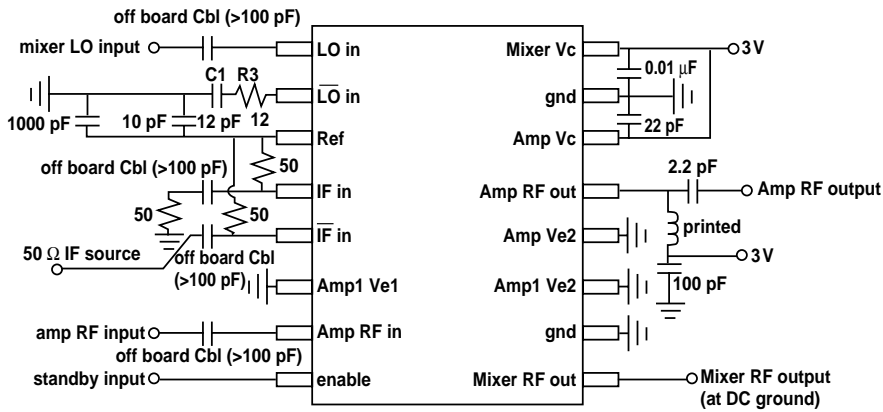

Figure 11. Test Board Configuration.

HPMX-2006 Circuit Use

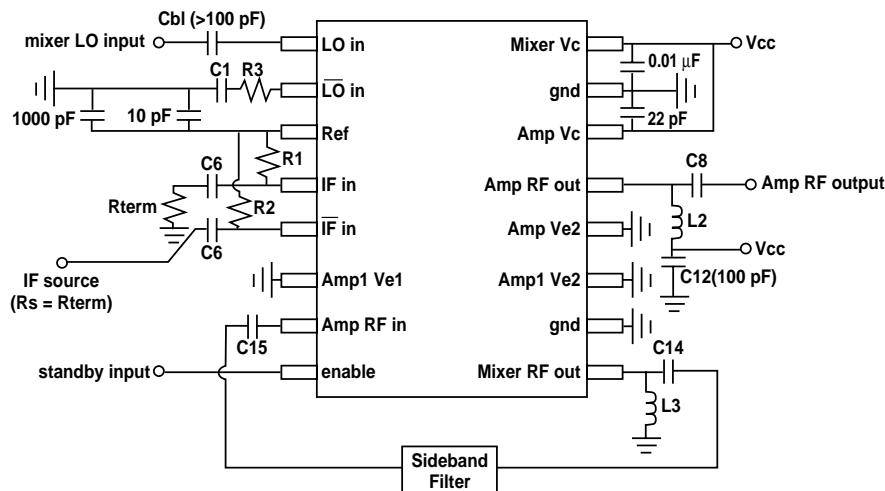

Figure 12. Schematic Diagram of Typical IC Use.

Table 2 lists values for components that change depending on

frequency of operation and AC or DC coupling of the IF input. For

2.5 GHz operation, a pre-amplifier may be inserted between the Mixer output and the Amp RF in.

Table 2. Values for Variable Components (see next page for details).

Component	Function	Value	Condition	Value	Condition	Notes
C1, R3	LO AC coupling	12 pF + 12 Ω	FLO < 1.75 GHz	2.7 pF + 0 Ω	FLO > 1.75 GHz	de-Q with R = 12 Ω for broadband operation < 1.75 GHz
C6	IF AC coupling	100 pF typ	AC coupled	short ckt	DC coupled	see also R1, R2
R1, R2	biases IF bases	50 Ω typ	AC coupled	open ckt	DC coupled	also sets load for optimum IF ^[1]
C8, L2	amp out match	see Table 3 for values vs. frequency				L2 set by position of C12
L3, C14	mixer output match	not used	1900 MHz operation	27 nH 1.3 pF ^[2]	900 MHz operation	900 MHz operation only
C15	amp input match	not used	1900 MHz operation	3.3 pF ^[2]	900 MHz operation	900 MHz operation only

Notes:

- Noise Optimum at R1, R2 = 150 Ω
- Optional

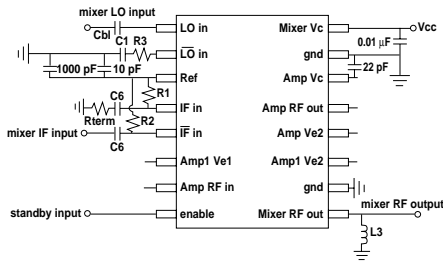

Figure 13. Mixer Only Use (AC Coupled Single-ended Use Shown). Refer to Table 2 for Component Values.

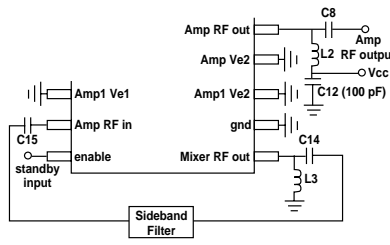

Figure 14. 900 MHz Use. Refer to Table 2 for Component Values.

Frequency, MHz	L2, nH	C8, pF
900	12.5	2.2
1500	5.4	2.2
1800	3.1	2.2
1900	2.8	2.2
2400	1.6	2.2

Table 3. Amp Output Match Component Values vs. Frequency.

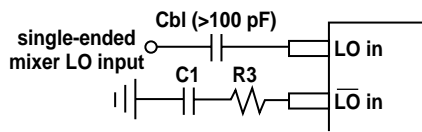

Figure 15. LO Connections for Single-ended Operation.

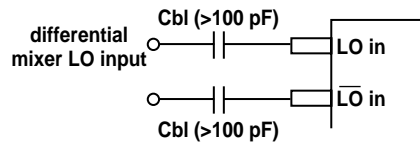

Figure 16. LO Connections for Balanced Operation.

1. LO in and LO bar in are identical; either can be used as the single-ended LO input with the other AC grounded.
2. R3 lowers the Q of the blocking capacitor to remove possible resonances for broadband operation below 1.75 GHz.

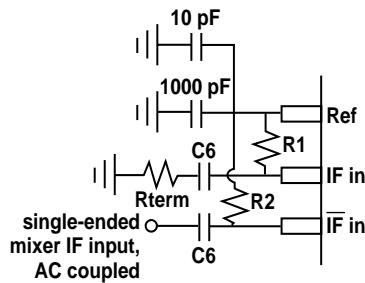

Figure 17. IF Connections for AC Coupled Single-ended Use.

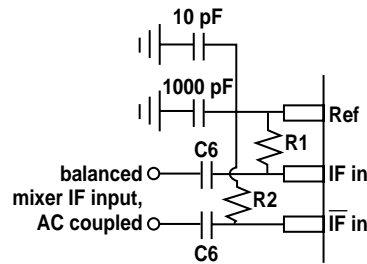

Figure 18. IF Connections for AC Coupled Balanced Use.

1. The IF pins require a bias voltage to operate properly (see Table 4). When the IF is AC coupled, this voltage is supplied from the Ref pin via R1 and R2. When the IF is DC coupled, the voltage is externally generated and the Ref pin is not used.
2. The base current is small, so to 1st order the value of R1, R2 can be selected to set the IF load impedance (50-200 ohm typ.)
3. IF in and IF bar in are identical; either can be used as the single-ended IF input with the other AC grounded.
4. Rterm (optional) should be the same value as the IF source impedance. It improves LO rejection by balancing the IF port and also de-Q's C6.

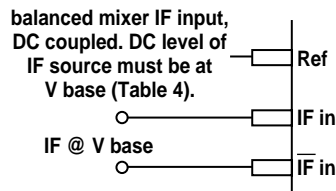

Figure 19. IF Connections for DC Coupled Use.

Vcc, V	Vbase, V
2.7	1.5
3.0	1.5
3.5	1.5-1.75
4.0	1.5-2.0
4.5	1.5-2.25
5.0	1.5-2.5

Table 4. Vbase vs. Vcc. Vbase is the required bias at the IF ports.

1. For DC coupled operation, the IF input must also supply Vbase to both IF in and IF in bar, per the values in Table 4. Ref pin is not used.

Part Number Ordering Information

Part Number	No. of Devices	Container
HPMX-2006-TR1	1000	Tape and Reel
HPMX-2006-BLK	25	Tape

Package Dimensions

JEDEC Standard SSOP-16 Package

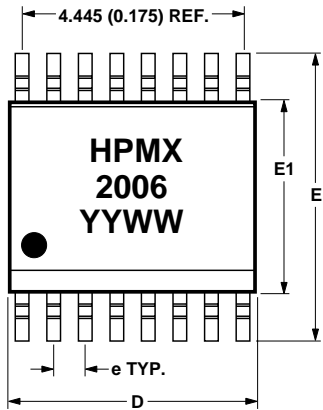

SYMBOL	DIMENSIONS	
	MIN.	MAX.
A	1.372 (0.054)	1.575 (0.062)
A1	0.127 (0.005)	0.254 (0.010)
b	0.203 (0.008)	0.305 (0.012)
C	0.178 (0.007)	0.254 (0.010)
D	4.801 (0.189)	5.004 (0.197)
E	5.867 (0.231)	6.121 (0.241)
e	0.635 BSC (0.025)	
E1	3.835 (0.151)	3.988 (0.157)
h	0.305 (0.012)	0.457 (0.018)
L	0.533 (0.021)	0.787 (0.031)
θ	0	8

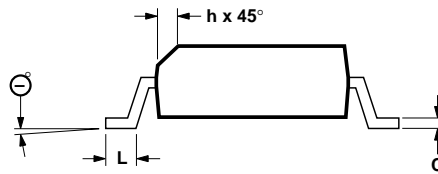
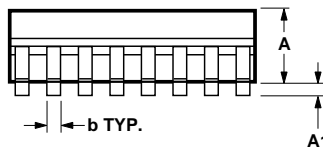

DIMENSIONS IN MILLIMETERS AND (INCHES).