

## Series PVD10

Microelectronic Power IC  
BOSFET® Photovoltaic Relay  
Single-Pole, 160mA, 0-100V DC

### General Description

The Photovoltaic DC Relay (PVD) is a single-pole, normally open solid state replacement for electro-mechanical relays used for general purpose switching of analog signals. It utilizes as an output switch a unique bidirectional (AC or DC) MOSFET power IC termed a BOSFET. The BOSFET is controlled by a photovoltaic generator of novel construction, which is energized by radiation from a dielectrically isolated light emitting diode (LED).

The PVD overcomes the limitations of both conventional and reed electromechanical relays by offering the solid state advantages of long life, high operating speed, low pick-up power, bounce-free operation, low thermal voltages and miniaturization. These advantages allow product improvement and design innovations in many applications such as process control, multiplexing, telecommunications, automatic test equipment and data acquisition.

The PVD can switch analog signals from thermocouple level to 100 volts peak DC. Signal frequencies into the RF range are easily controlled and switching rates up to 18kHz are achievable. The extremely small thermally generated offset voltages allow increased measurement accuracies.

Unique silicon technology developed by International Rectifier forms the heart of the PVD. The monolithic BOSFET contains a bidirectional N-channel power MOSFET output structure. In addition, this power IC chip has input circuitry for fast turn-off and gate protection functions. This section of the BOSFET chip utilizes both bipolar and MOS technology to form NPN transistors, P-channel MOSFETs, resistors, diodes and capacitors.

The photovoltaic generator similarly utilizes a unique International Rectifier alloyed multijunction structure. The excellent current conversion efficiency of this technique results in the very fast response of the PVD microelectronic power IC relay.

This advanced semiconductor technology has created a radically new control device. Designers can now develop switching systems to new standards of electrical performance and mechanical compactness.

### Features

- BOSFET Power IC ■
- 10<sup>10</sup> Operations ■
- 25µsec Operating Time ■
- 3 milliwatts Pick-Up Power ■
- 1000V/µsec dv/dt ■
- Bounce-Free ■
- 8-pin DIP Package ■
- 40°C to 85°C ■
- UL recognized ■

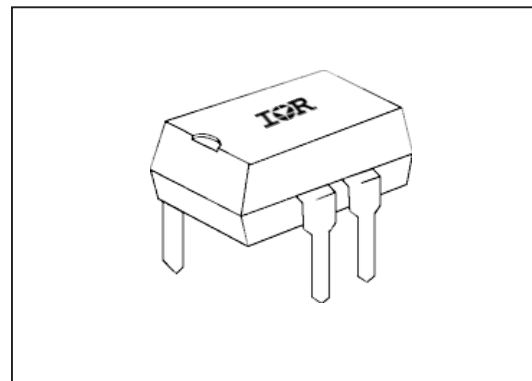

### Part Identification

Part Number	Operating Voltage (DC)	Sensitivity	Off-State Resistance
PVD1052	0 – 100V	5 mA	10 <sup>8</sup> Ohms
PVD1054			10 <sup>10</sup> Ohms

*(BOSFET is a trademark of International Rectifier)*

**Electrical Specifications** ( $-40^{\circ}\text{C} \leq T_A \leq +85^{\circ}\text{C}$  unless otherwise specified)

<b>INPUT CHARACTERISTICS</b>	<b>PVD1052</b>	<b>PVD1054</b>	<b>Units</b>
Minimum Control Current (see figures 1 and 2) For 80mA Continuous Load Current For 130mA Continuous Load Current For 50mA Continuous Load Current	2.0 5.0 5.0		DC mA@25°C mA@40°C mA@80°C
Maximum Control Current for Off-State Resistance at 25°C	10		μA(DC)
Control Current Range (Caution: current limit input LED. See figure 6)	2.0 to 25		mA(DC)
Maximum Reverse Voltage	7.0		V(DC)

<b>OUTPUT CHARACTERISTICS</b>	<b>PVD1052</b>	<b>PVD1054</b>	<b>Units</b>
Operating Voltage Range	0 to ± 100		V <sub>(RMS)</sub>
Maximum Load Current 40°C (see figures 1 and 2)	160		mA(DC)
Response Time @25°C (see figures 7 and 8) Max. T <sub>(on)</sub> @ 12mA Control, 50 mA Load, 50 VDC, 0 to 90% Max. T <sub>(off)</sub> @ 12mA Control, 50 mA Load, 50 VDC, 100% to 10%	25 15		μs μs
Max. On-state Resistance 25°C (Pulsed) (fig. 4) 50 mA Load, 5mA Control	8.0		Ω
Min. Off-state Resistance 25°C @ 80 VDC (see figure 5)	10 <sup>8</sup>	10 <sup>10</sup>	Ω
Max. Thermal Offset Voltage @ 5.0mA Control	0.2		μvolts
Min. Off-State dv/dt	1000		V/μs
Output Capacitance	8.0		pF @ 50VDC

<b>GENERAL CHARACTERISTICS (PVD1052 and PVD1054)</b>		<b>Units</b>	
Dielectric Strength: Input-Output		2500	V <sub>RMS</sub>
Insulation Resistance: Input-Output @ 90V <sub>DC</sub>		10 <sup>12</sup> @ 25°C - 50% RH	Ω
Maximum Capacitance: Input-Output		1.0	pF
Max. Pin Soldering Temperature (1.6mm below seating plane, 10 seconds max.)		+260	°C
Ambient Temperature Range:	Operating	-40 to +85	
	Storage	-40 to +100	

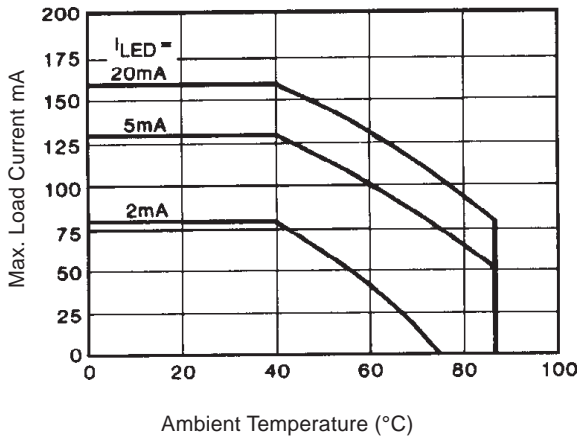

Figure 1. Current Derating Curves

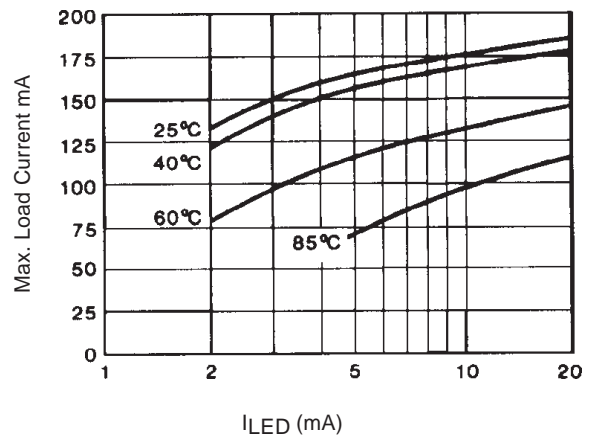

Figure 2. Typical Control Current Requirements

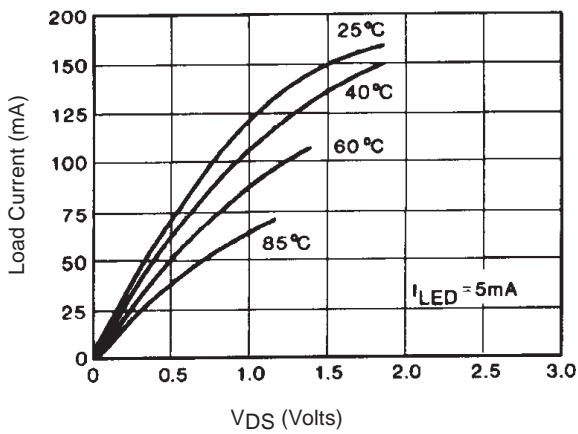

Figure 3. Typical On Characteristics

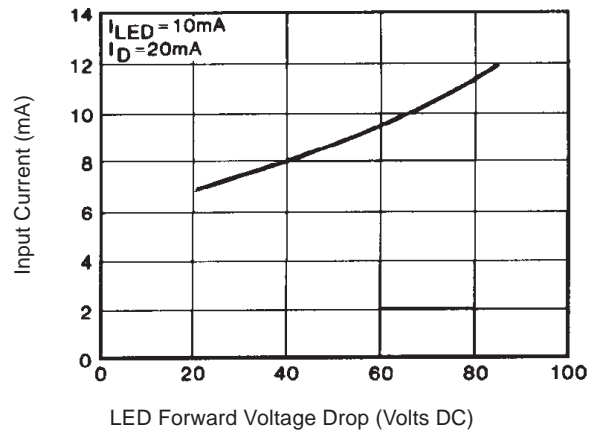

Figure 4. Typical On-Resistance

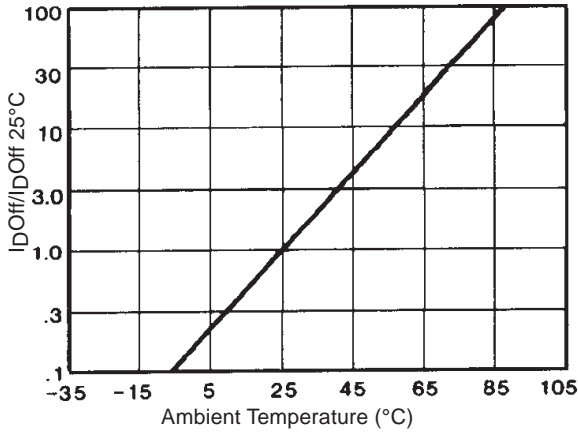

Figure 5. Normalized Off-State Leakage

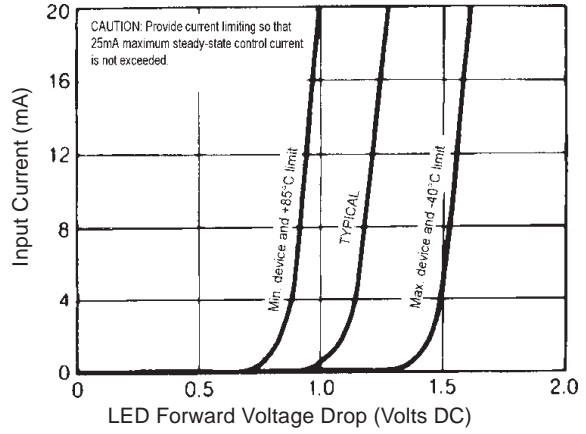

Figure 6. Input Characteristics (Current Controlled)

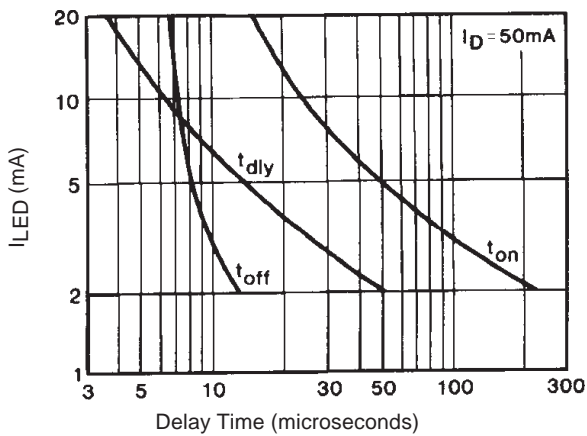

Figure 7. Typical Delay Times

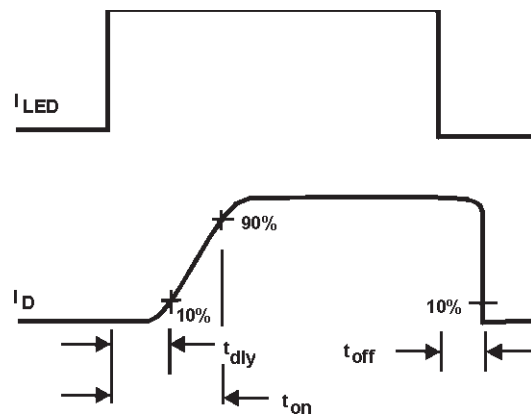

Figure 8. Delay Time Definitions

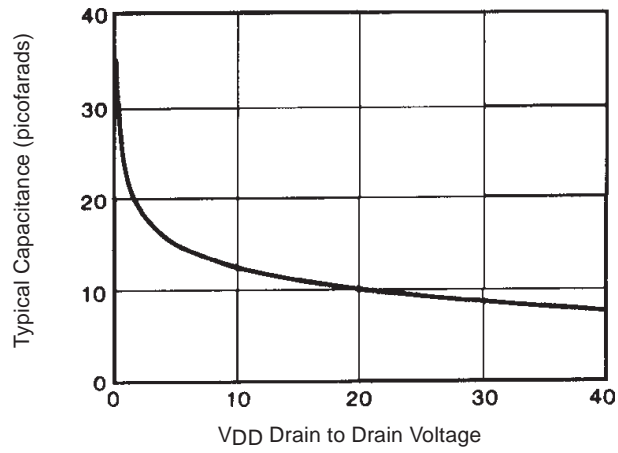

Figure 9. Typical Output Capacitance

## Wiring Diagram

