

Features

- Low On-Resistance
- Very Low Gate Threshold Voltage, 0.9V Max.
- Fast Switching Speed
- Low Input/Output Leakage
- Ultra-Small Surface Mount Package
- **Lead Free By Design/RoHS Compliant (Note 2)**
- **"Green" Device (Note 4)**
- **ESD Protected Gate**
- **Ultra Low Profile Package**

Mechanical Data

- Case: DFN1310H4-6
- Case Material: Molded Plastic, "Green" Molding Compound. UL Flammability Classification Rating 94V-0
- Moisture Sensitivity: Level 1 per J-STD-020
- Terminal Connections: See Diagram
- Terminals: Finish — NiPdAu annealed over Copper leadframe. Solderable per MIL-STD-202, Method 208
- Marking Information: See Page 3
- Ordering Information: See Page 3

DFN1310H4-6

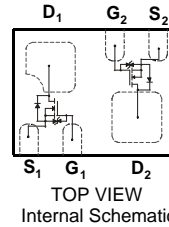

Maximum Ratings @ $T_A = 25^\circ\text{C}$ unless otherwise specified

Characteristic	Symbol	Value	Unit
Drain-Source Voltage	V_{DSS}	20	V
Gate-Source Voltage	V_{GSS}	± 10	V
Drain Current per element (Note 1)	I_D	Continuous	200
		Pulsed (Note 3)	250

Thermal Characteristics @ $T_A = 25^\circ\text{C}$ unless otherwise specified

Characteristic	Symbol	Value	Unit
Total Power Dissipation (Note 1)	P_D	350	mW
Thermal Resistance, Junction to Ambient	$R_{\theta JA}$	357	$^\circ\text{C/W}$
Operating and Storage Temperature Range	T_J, T_{STG}	-65 to +150	$^\circ\text{C}$

Electrical Characteristics @ $T_A = 25^\circ\text{C}$ unless otherwise specified

Characteristic	Symbol	Min	Typ	Max	Unit	Test Condition
OFF CHARACTERISTICS (per element) (Note 5)						
Drain-Source Breakdown Voltage	BV_{DSS}	20	—	—	V	$V_{GS} = 0V, I_D = 100\mu\text{A}$
Zero Gate Voltage Drain Current	I_{DSS}	—	—	10	μA	$V_{DS} = 17V, V_{GS} = 0V$
Gate-Source Leakage	I_{GSS}	—	—	± 5	μA	$V_{GS} = \pm 8V, V_{DS} = 0V$
ON CHARACTERISTICS (per element) (Note 5)						
Gate Threshold Voltage	$V_{GS(th)}$	0.53	—	0.9	V	$V_{DS} = V_{GS}, I_D = 100\mu\text{A}$
Static Drain-Source On-Resistance	$R_{DS(on)}$	—	0.9	1.5	Ω	$V_{GS} = 4V, I_D = 10\text{mA}$
		—	0.85	1.7		$V_{GS} = 2.7V, I_D = 200\text{mA}$
		—	1.2	1.7		$V_{GS} = 2.5V, I_D = 10\text{mA}$
		—	2.4	3.5		$V_{GS} = 1.8V, I_D = 200\text{mA}$
		—	2.5	3.5		$V_{GS} = 1.5V, I_D = 1\text{mA}$
Forward Transfer Admittance	$ Y_{fs} $	40	—	—	mS	$V_{DS} = 3V, I_D = 10\text{mA}$

- Notes:
1. Device mounted on FR-4 PCB.
 2. No purposefully added lead.
 3. Pulse width $\leq 10\mu\text{s}$, Duty Cycle $\leq 1\%$.
 4. Diodes Inc.'s "Green" policy can be found on our website at http://www.diodes.com/products/lead_free/index.php.
 5. Short duration pulse test used to minimize self-heating effect.

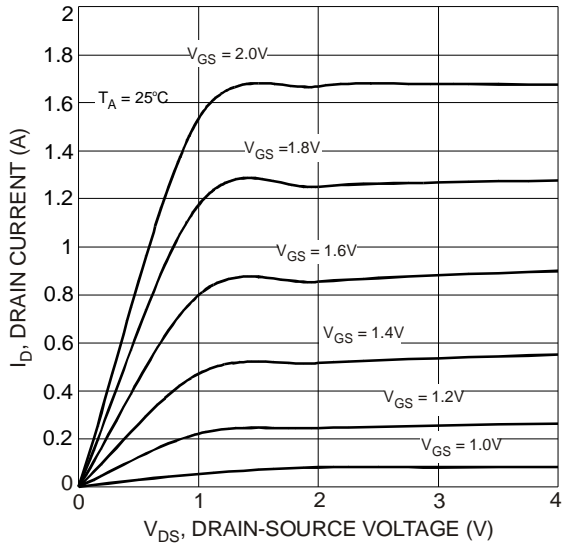

Fig. 1 Typical Output Characteristics

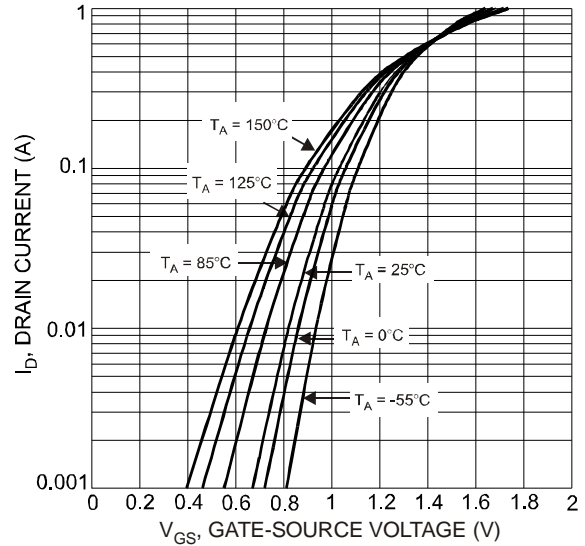

Fig. 2 Reverse Drain Current vs. Source-Drain Voltage

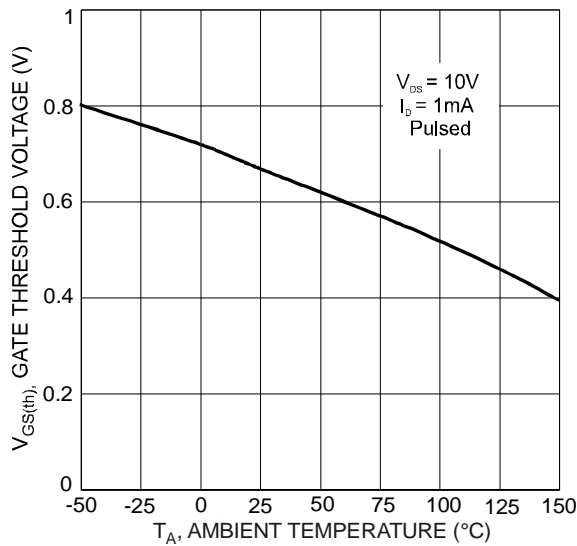

Fig. 3 Gate Threshold Voltage vs. Ambient Temperature

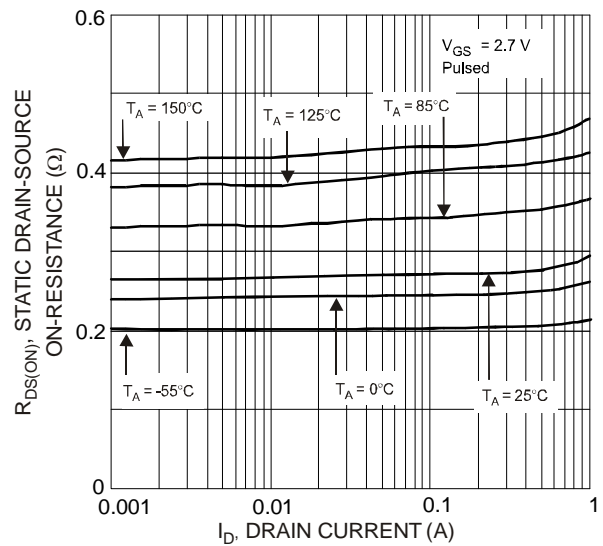

Fig. 4 Static Drain-Source On-State Resistance vs. Drain Current

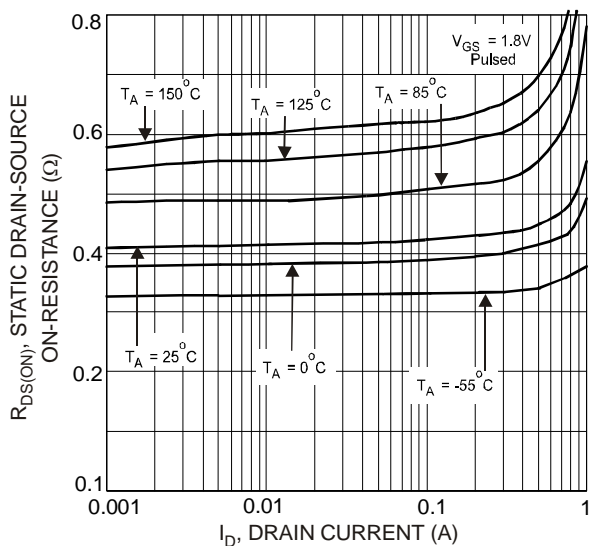

Fig. 5 Static Drain-Source On-Resistance vs. Drain Current

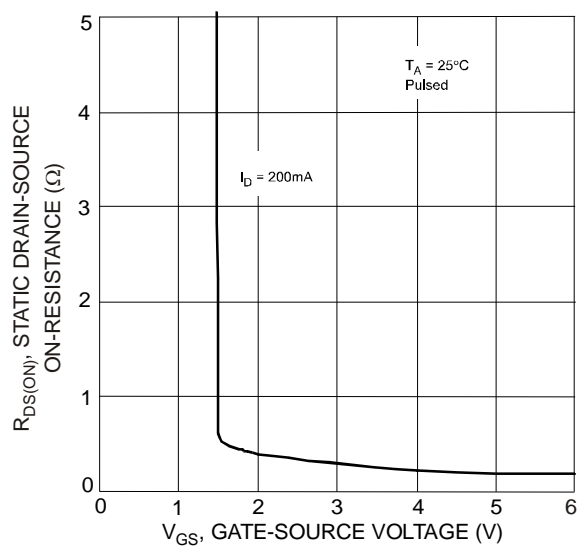

Fig. 6 Static Drain-Source, On-Resistance vs. Gate-Source Voltage

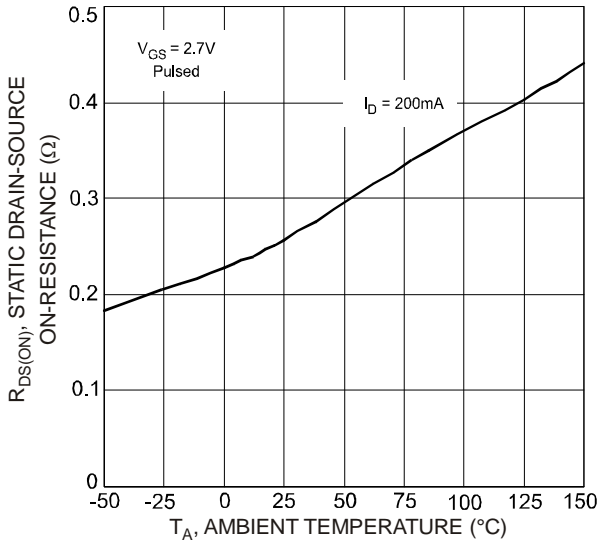

Fig. 7 Static Drain-Source, On-Resistance vs. Ambient Temperature

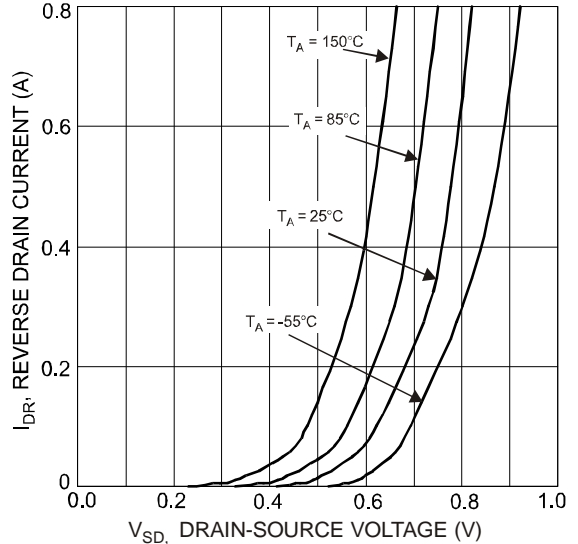

Fig. 8 Reverse Drain Current vs. Source-Drain Voltage

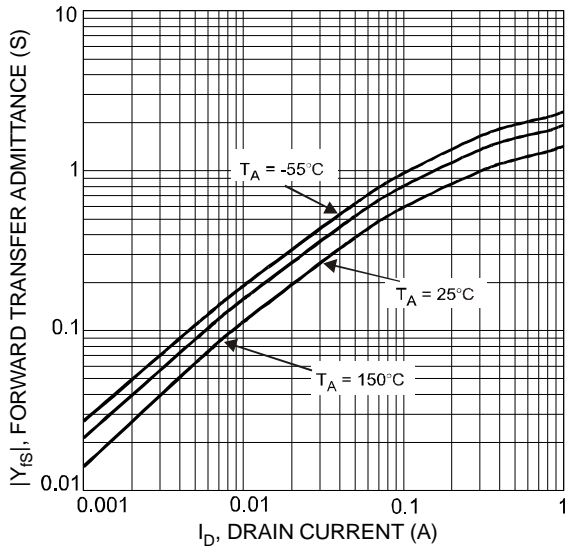

Fig. 9 Forward Transfer Admittance vs. Drain Current

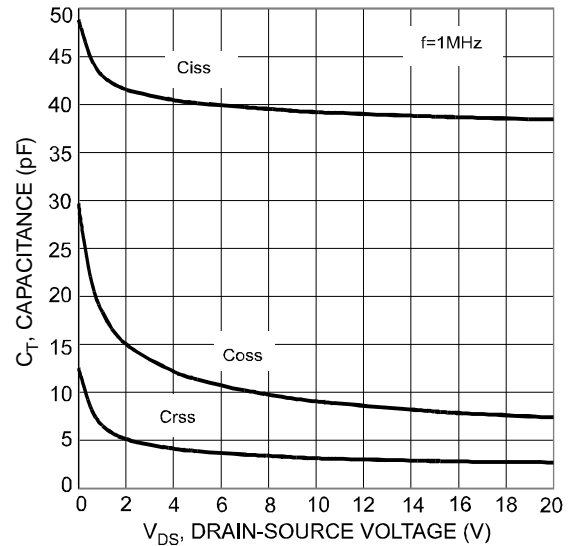

Fig. 10 Typical Capacitance

Ordering Information (Note 6)

Part Number	Case	Packaging
DMN2005DLP4K-7	DFN1310H4-6	3000/Tape & Reel

Notes: 6. For packaging details, go to our website at <http://www.diodes.com/datasheets/ap02007.pdf>.

Marking Information



DL = Product Type Marking Code

Package Outline Dimensions

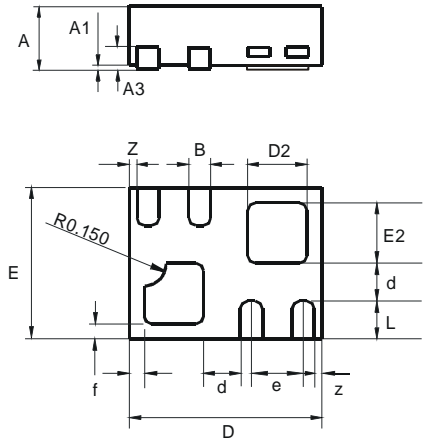

DFN1310H4-6			
Dim	Min	Max	Typ
A	—	0.40	—
A1	0	0.05	0.02
A3	—	—	0.13
b	0.10	0.20	0.15
D	1.25	1.38	1.30
d	—	—	0.25
D2	0.30	0.50	0.40
E	0.95	1.075	1.00
e	—	—	0.35
E2	0.30	0.50	0.40
f	—	—	0.10
L	0.20	0.30	0.25
Z	—	—	0.05
All Dimensions in mm			

Suggested Pad Layout

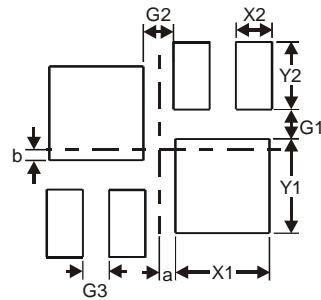

Dimensions	Value (in mm)
G1	0.16
G2	0.17
G3	0.15
X1	0.52
X2	0.20
Y1	0.52
Y2	0.375
a	0.09
b	0.06

IMPORTANT NOTICE

DIODES INCORPORATED MAKES NO WARRANTY OF ANY KIND, EXPRESS OR IMPLIED, WITH REGARDS TO THIS DOCUMENT, INCLUDING, BUT NOT LIMITED TO, THE IMPLIED WARRANTIES OF MERCHANTABILITY AND FITNESS FOR A PARTICULAR PURPOSE (AND THEIR EQUIVALENTS UNDER THE LAWS OF ANY JURISDICTION).

Diodes Incorporated and its subsidiaries reserve the right to make modifications, enhancements, improvements, corrections or other changes without further notice to this document and any product described herein. Diodes Incorporated does not assume any liability arising out of the application or use of this document or any product described herein; neither does Diodes Incorporated convey any license under its patent or trademark rights, nor the rights of others. Any Customer or user of this document or products described herein in such applications shall assume all risks of such use and will agree to hold Diodes Incorporated and all the companies whose products are represented on Diodes Incorporated website, harmless against all damages.

Diodes Incorporated does not warrant or accept any liability whatsoever in respect of any products purchased through unauthorized sales channel. Should Customers purchase or use Diodes Incorporated products for any unintended or unauthorized application, Customers shall indemnify and hold Diodes Incorporated and its representatives harmless against all claims, damages, expenses, and attorney fees arising out of, directly or indirectly, any claim of personal injury or death associated with such unintended or unauthorized application.

Products described herein may be covered by one or more United States, international or foreign patents pending. Product names and markings noted herein may also be covered by one or more United States, international or foreign trademarks.

LIFE SUPPORT

Diodes Incorporated products are specifically not authorized for use as critical components in life support devices or systems without the express written approval of the Chief Executive Officer of Diodes Incorporated. As used herein:

A. Life support devices or systems are devices or systems which:

1. are intended to implant into the body, or
2. support or sustain life and whose failure to perform when properly used in accordance with instructions for use provided in the labeling can be reasonably expected to result in significant injury to the user.

B. A critical component is any component in a life support device or system whose failure to perform can be reasonably expected to cause the failure of the life support device or to affect its safety or effectiveness.

Customers represent that they have all necessary expertise in the safety and regulatory ramifications of their life support devices or systems, and acknowledge and agree that they are solely responsible for all legal, regulatory and safety-related requirements concerning their products and any use of Diodes Incorporated products in such safety-critical, life support devices or systems, notwithstanding any devices- or systems-related information or support that may be provided by Diodes Incorporated. Further, Customers must fully indemnify Diodes Incorporated and its representatives against any damages arising out of the use of Diodes Incorporated products in such safety-critical, life support devices or systems.

Copyright © 2009, Diodes Incorporated

www.diodes.com