

GaAs MMIC SPDT NON-REFLECTIVE SWITCH, DC - 28.0 GHz

Typical Applications

The HMC547LC3 is ideal for:

- Fiber Optics & Broadband Telecom
- Microwave Radio & VSAT
- Military Radios, Radar, & ECM
- Test Instrumentation

Features

- High Isolation: 45 dB @ 10 GHz
40 dB @ 20 GHz
- Low Insertion Loss: 1.6 dB @ 10 GHz
1.9 dB @ 20 GHz
- Fast Switching: 6 ns
- Non-Reflective Design
- 16 Lead Ceramic 3x3 mm SMT Package: 9mm²

Functional Diagram

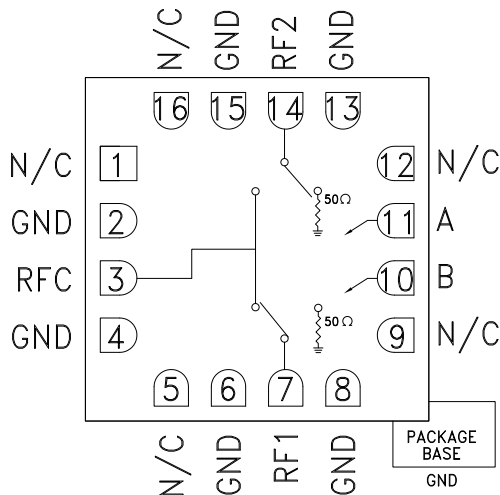

General Description

The HMC547LC3 is a general purpose broadband high isolation non-reflective GaAs MESFET SPDT switch in a ceramic 3x3 mm leadless surface mount package. Covering DC to 28.0 GHz, the switch offers over 40 dB isolation and less than 2 dB insertion loss at midband. The wide bandwidth, fast switching, and compact size make this absorptive SPDT ideal for military EW/ECM and test equipment applications. The switch operates using complementary negative control voltage logic lines of -5/0V and requires no bias supply.

Electrical Specifications, $T_A = +25^\circ \text{C}$, With 0/-5V Control, 50 Ohm System

| Parameter | Frequency | Min. | Typ. | Max. | Units |
|---|-----------------|----------------------------------|------|------|-------|
| Insertion Loss | DC - 10.0 GHz | | 1.6 | 2.2 | dB |
| | 10.0 - 20.0 GHz | | 1.9 | 2.5 | dB |
| | 20.0 - 28.0 GHz | | 2.4 | 3.0 | dB |
| Isolation | DC - 10.0 GHz | 40 | 45 | | dB |
| | 10.0 - 20.0 GHz | 34 | 40 | | dB |
| | 20.0 - 28.0 GHz | 30 | 34 | | dB |
| Return Loss | "On State" | | 17 | | dB |
| Return Loss RF1, RF2 | "Off State" | | 25 | | dB |
| | DC - 10.0 GHz | | 15 | | dB |
| | 10.0 - 20.0 GHz | | 8 | | dB |
| Input Power for 1 dB Compression | DC - 0.5 GHz | | 16 | | dBm |
| | 0.5 - 28.0 GHz | 20 | 23 | | dBm |
| Input Third Order Intercept (Two-Tone Input Power= +7 dBm Each Tone) | DC - 0.5 GHz | | 26 | | dBm |
| | 0.5 - 28.0 GHz | | 46 | | dBm |
| Switching Characteristics | DC - 28.0 GHz | tRISE, tFALL (10/90% RF) | 3 | | ns |
| | | tON, tOFF (50% CTL to 10/90% RF) | 6 | | ns |

GaAs MMIC SPDT NON-REFLECTIVE SWITCH, DC - 28.0 GHz

Insertion Loss

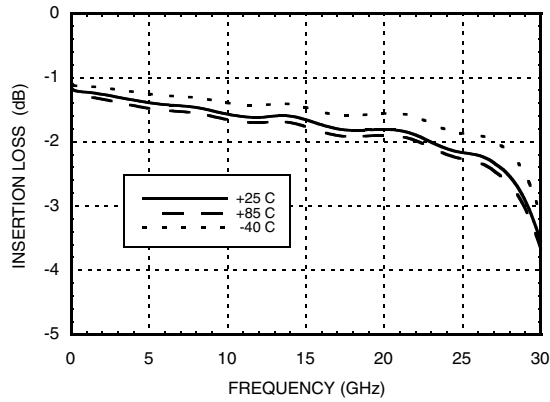

Return Loss

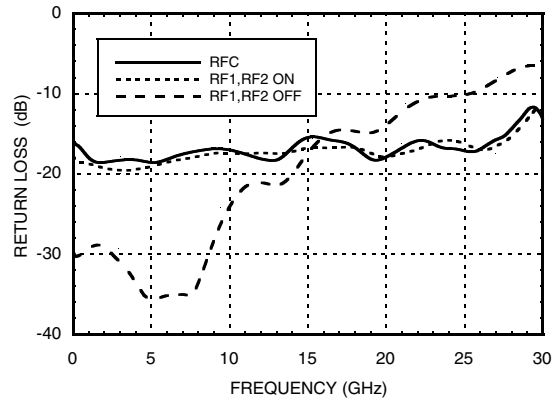

Isolation Between Ports RFC and RF1/RF2

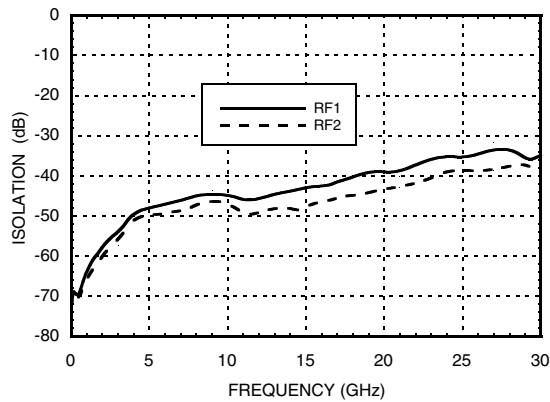

Isolation Between Ports RF1 and RF2

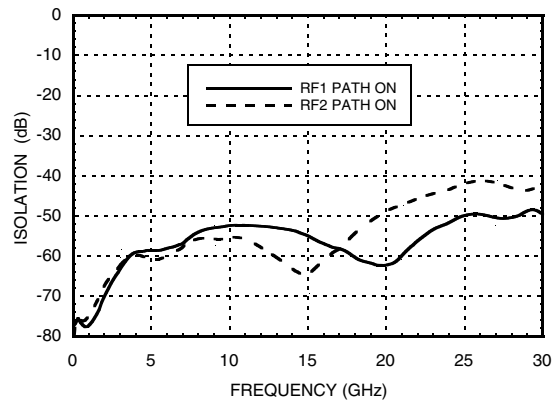

Input P1dB and P0.1dB Compression Point

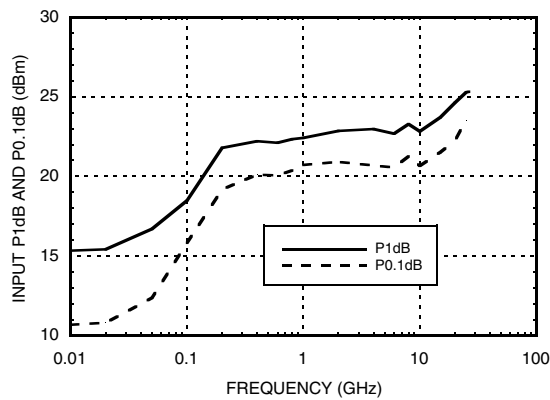

Input Third Order Intercept Point

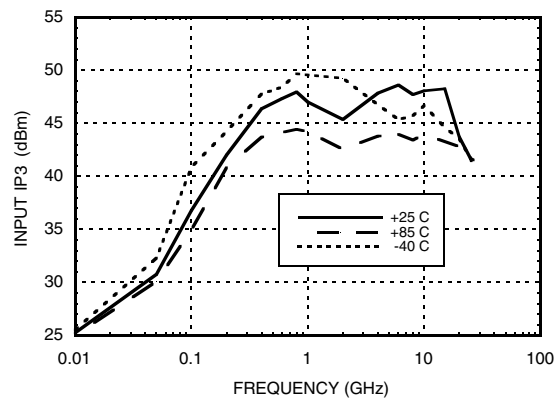

GaAs MMIC SPDT NON-REFLECTIVE SWITCH, DC - 28.0 GHz
Absolute Maximum Ratings

| | |
|---|----------------|
| RF Input Power (A,B = 0V/-5V) | +25 dBm |
| Control Voltage Range (A & B) | +5.0V to -7.5V |
| Hot Switch Power Level (A,B = 0V/-5V) | +22 dBm |
| Channel Temperature | 150 °C |
| Continuous Pdiss (T=85°C) (derate 3.3 mW/°C above 85°C) (Insertion Loss Path) | 0.215 W |
| Thermal Resistance (Insertion Loss Path) | 302 °C/W |
| Continuous Pdiss (T=85°C) (derate 5.6 mW/°C above 85°C) (Terminated Path) | 0.363 W |
| Thermal Resistance (Terminated Path) | 179 °C/W |
| Storage Temperature | -65 to +150 °C |
| Operating Temperature | -40 to +85 °C |
| ESD Sensitivity (HBM) | Class 1A |

Control Voltages

| State | Bias Condition |
|-------|--|
| Low | 0 to -0.5V @ 10 uA Max. |
| High | -5V @ 3 uA Typ. to -7V @ 10 uA Typ. (± 0.5V) |

Truth Table

| Control Input | | Signal Path State | |
|---------------|------|-------------------|------------|
| A | B | RFC to RF1 | RFC to RF2 |
| High | Low | On | Off |
| Low | High | Off | On |

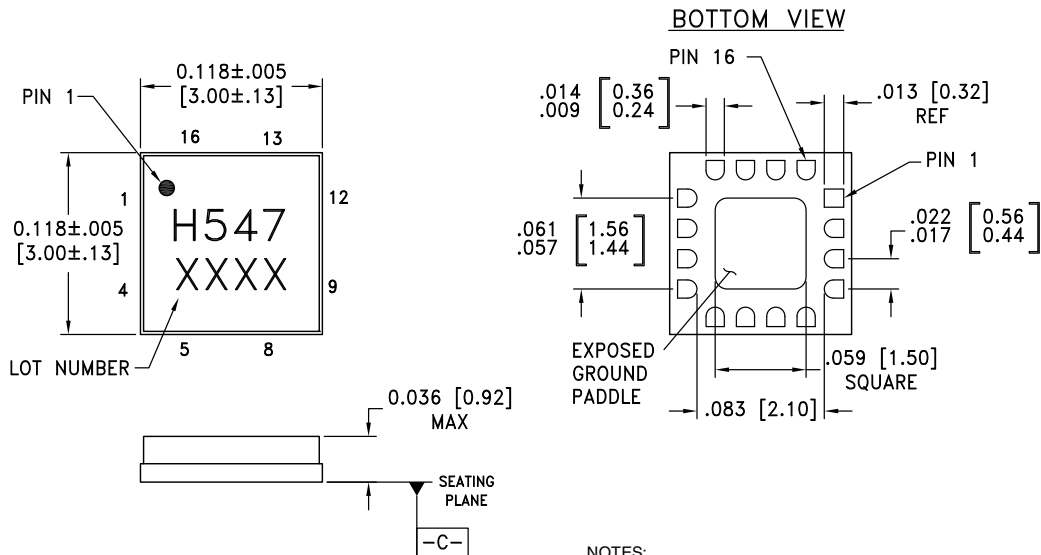

**ELECTROSTATIC SENSITIVE DEVICE
OBSERVE HANDLING PRECAUTIONS**

GaAs MMIC SPDT NON-REFLECTIVE SWITCH, DC - 28.0 GHz
Outline Drawing

NOTES:

1. PACKAGE BODY MATERIAL: ALUMINA.
2. LEAD AND GROUND PADDLE PLATING: GOLD FLASH OVER NICKEL.
3. DIMENSIONS ARE IN INCHES (MILLIMETERS).
4. LEAD SPACING TOLERANCE IS NON-CUMULATIVE.
5. PACKAGE WARP SHALL NOT EXCEED 0.05MM DATUM -C-
6. ALL GROUND LEADS AND GROUND PADDLE MUST BE SOLDERED TO PCB RF GROUND.

Package Information

| Part Number | Package Body Material | Lead Finish | MSL Rating | Package Marking ^[2] |
|-------------|-----------------------|------------------|---------------------|--------------------------------|
| HMC547LC3 | Alumina, White | Gold over Nickel | MSL1 ^[1] | H547 XXXX |

[1] Max peak reflow temperature of 260 °C

[2] 4-Digit lot number XXXX



GaAs MMIC SPDT NON-REFLECTIVE SWITCH, DC - 28.0 GHz

Pin Descriptions

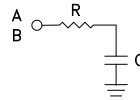
| Pin Number | Function | Description | Interface Schematic |
|--------------------|---------------|---|---|
| 1, 5, 9, 12, 16 | N/C | This pin should be connected to PCB RF ground to maximize isolation | |
| 2, 4, 6, 8, 13, 15 | GND | Package bottom has exposed metal paddle that must also be connected to PCB RF ground. |  |
| 3, 7, 14 | RFC, RF1, RF2 | This pin is DC coupled and matched to 50 Ohm. Blocking capacitors are required if RF line potential is not equal to 0V. | |
| 10 | B | See truth table and control voltage table. |  |
| 11 | A | See truth table and control voltage table. | |

Evaluation PCB

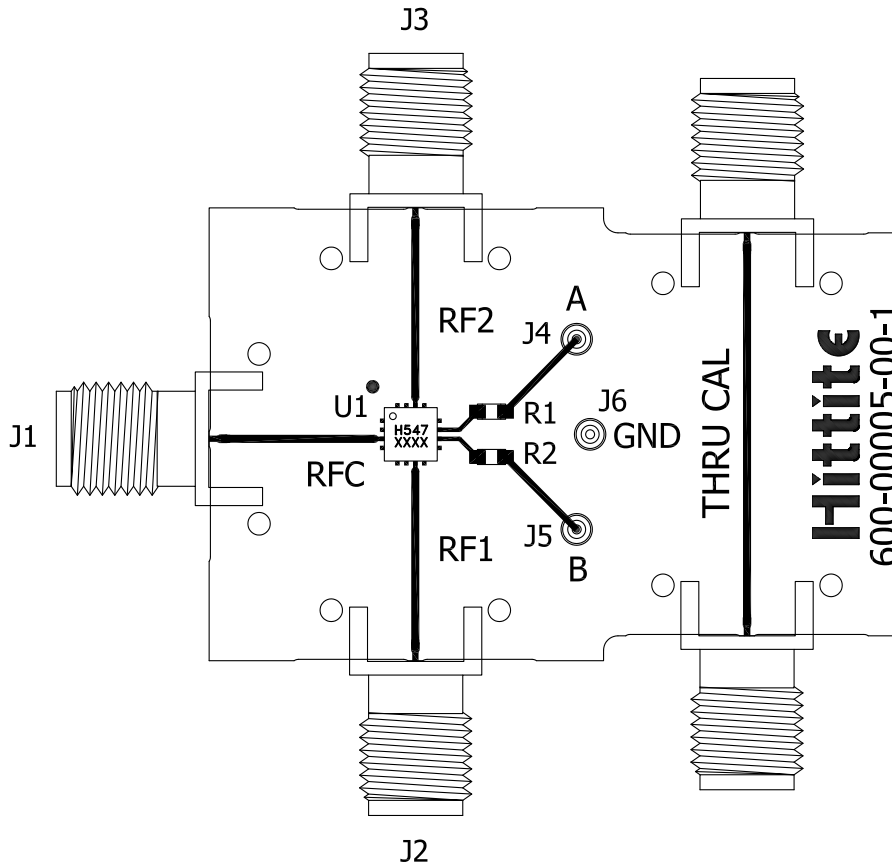

List of Materials for Evaluation PCB EVAL01-HMC547LC3 [1]

| Item | Description |
|---------|-------------------------------|
| J1 - J3 | PCB Mount SRI SMA Connector |
| J4 - J6 | DC Pin |
| R1 - R2 | 100 Ohm Resistor, 0603 Pkg. |
| U1 | HMC547LC3 SPDT Switch |
| PCB [2] | 600-00005-00-1 Evaluation PCB |

[1] Reference this number when ordering complete evaluation PCB

[2] Circuit Board Material: Rogers 4350

The circuit board used in the application should be generated with proper RF circuit design techniques. Signal lines at the RF port should have 50 Ohm impedance and the package ground leads and package bottom should be connected directly to the ground plane similar to that shown above. The evaluation circuit board shown above is available from Hittite Microwave Corporation upon request.