

Typical Applications

The HMC546LP2 / HMC546LP2E is ideal for:

- LNA Protection, WiMAX, WiBro
- Cellular/PCS/3G, TD-SCDMA Infrastructure
- Private Mobile Radio and Public Safety Handsets
- Automotive Telematics

Functional Diagram

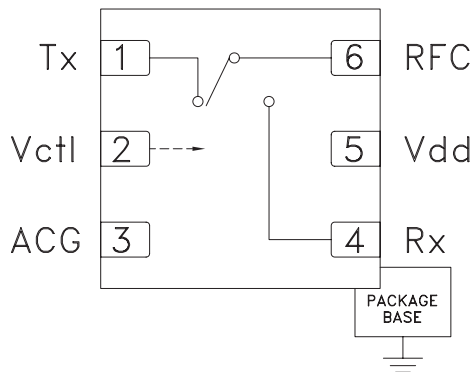

Features

- High Input P0.1 dB: +40 dBm Tx
- Low Insertion Loss: 0.4 dB
- High IIP3: +67 dBm
- Positive Control: 0/+3V to 0/+8V
- Failsafe Operation - Tx "On" When Unpowered

General Description

The HMC546LP2 & HMC546LP2E are failsafe SPDT switches in leadless DFN surface mount plastic packages for use in transmit-receive, and LNA protection applications which require very low distortion and high power handling of up to 10 watts. The device can control signals from 200 - 2700 MHz* and is especially suited for WiMAX and WiBro repeaters, PMR and automotive telematic applications. The design provides exceptional P0.1 dB of +40 dBm and +65 dBm IIP3 on the Transmit (Tx) port. The failsafe topology allows the switch to provide a low loss path from RFC to Tx, when no DC power is available.

Electrical Specifications, $T_A = +25^\circ\text{C}$, $V_{ctl} = 0/+3\text{Vdc}$, 50 Ohm System*

Parameter	Min.	Typ.	Max.	Min.	Typ.	Max.	Min.	Typ.	Max.	Min.	Typ.	Max.	Units
Frequency Range	1805 - 1910			2010 - 2025			2300 - 2480			2500 - 2700			MHz
Insertion Loss	Tx - RFC	0.3	0.6		0.4	0.7		0.6	0.8		0.5	0.8	dB
	RFC - Rx	0.4	0.7		0.3	0.6		1.1	1.5		0.7	1.1	dB
Isolation	Tx - RFC	15	23		15	22		15	20		10	15	dB
	RFC - Rx	22	30		20	27		25	30		30	40	dB
Return Loss	Tx - RFC		25			20			22			20	dB
	RFC - Rx		25			25			10			12	dB
Input Power for 0.1 dB Compression	Tx - RFC	38	40		39	41		36.5	38.5		38.5	40.5	dBm
	RFC - Rx	19	21		19	21		17	19		18	20	dBm
Input Third Order Intercept (Two-tone input power = +19 dBm each tone)	Tx - RFC		65			64			67			62	dBm
	$V_{ctl} = 0/+3\text{V}$ RFC - Rx		33			32			33			32	dBm
	Tx - RFC		66			64			67			62	dBm
	$V_{ctl} = 0/+5\text{V}$ RFC - Rx		44			45			45			43	dBm
Switching Characteristics	tRISE, tFALL (10/90% RF)		21			21			21			21	ns
	tON, (50% CTL to 90% RF)		102			102			102			102	ns
	tOFF (50% CTL to 10% RF)		36			36			36			36	ns

$T_A = +25^\circ\text{C}$, V_{ctl} & V_{dd} Unpowered

Insertion Loss	Tx - RFC		0.3	0.6		0.4	0.7		0.6	0.8		0.5	0.8	dB
Isolation	RFC - Rx	15	23		15	22		15	20		10	15	dB	
Return Loss	Tx - RFC		25			20			22			20	dB	
Input Power for 0.1 dB Compression	Tx - RFC	38	40		39	41		36.5	38.5		38.5	40.5	dBm	

* Specifications and data reflect HMC546LP2 measured using the respective application circuits for each designated frequency band found herein

For price, delivery, and to place orders, please contact Hittite Microwave Corporation:
20 Alpha Road, Chelmsford, MA 01824 Phone: 978-250-3343 Fax: 978-250-3373
Order On-line at www.hittite.com



Insertion Loss vs. Temperature, Tx with 1843 MHz Tuning

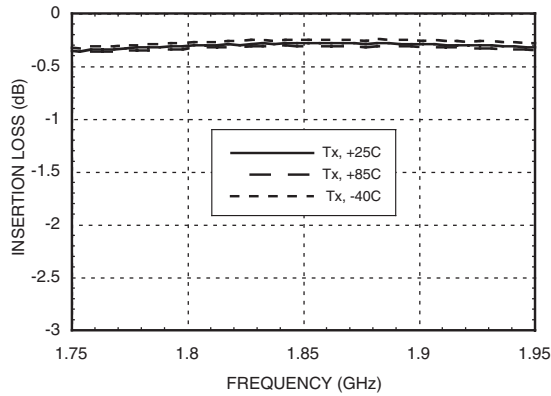

Insertion Loss vs. Temperature, Rx with 1843 MHz Tuning

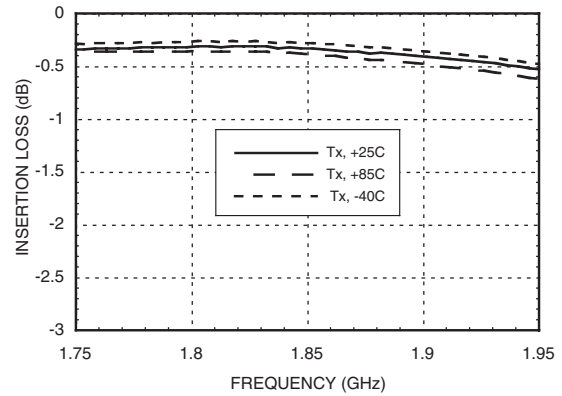

Isolation with 1843 MHz Tuning

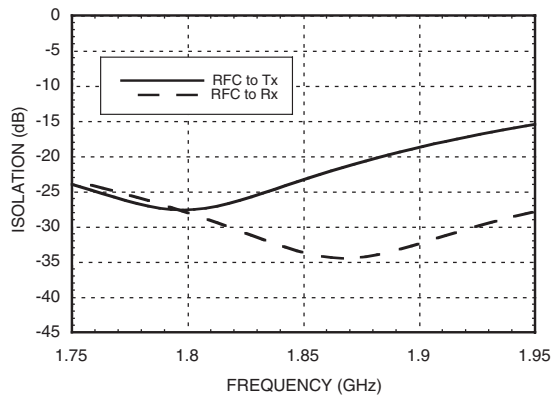

Return Loss with 1843 MHz Tuning

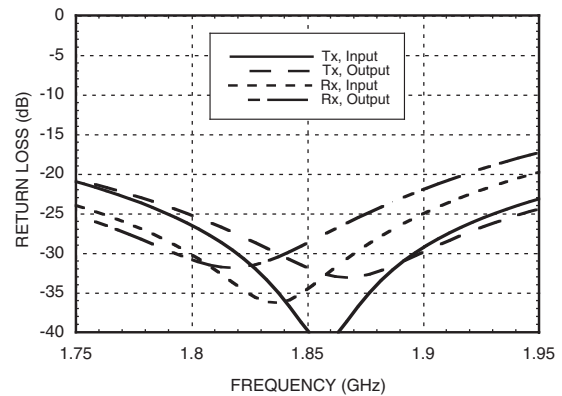

Input IP3 vs. Voltage with 1843 MHz Tuning

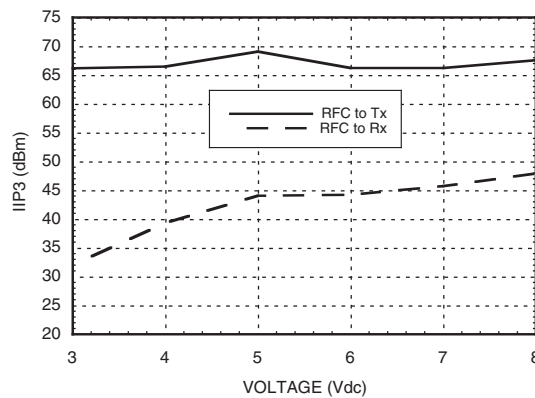



Insertion Loss vs. Temperature, Tx with 2015 MHz Tuning

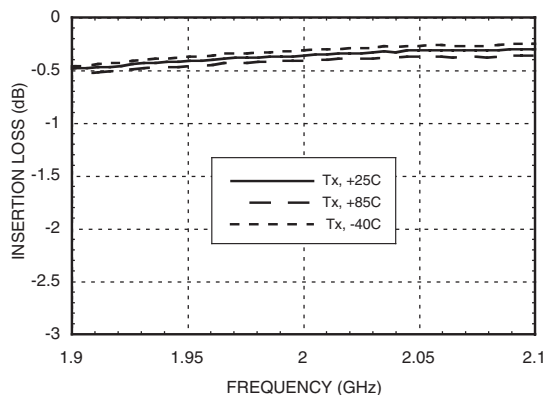

Insertion Loss vs. Temperature, Rx with 2015 MHz Tuning

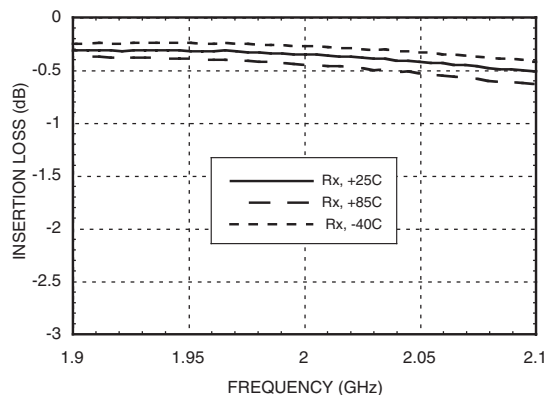

Isolation with 2015 MHz Tuning

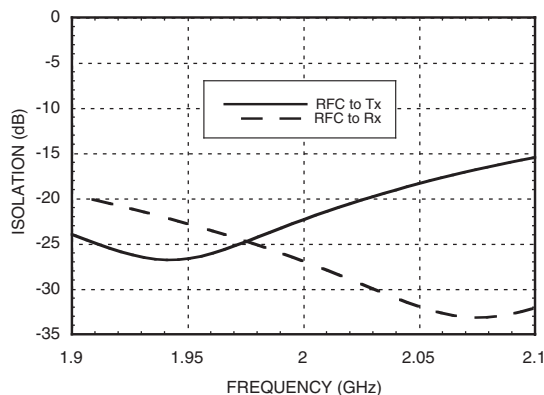

Return Loss with 2015 MHz Tuning

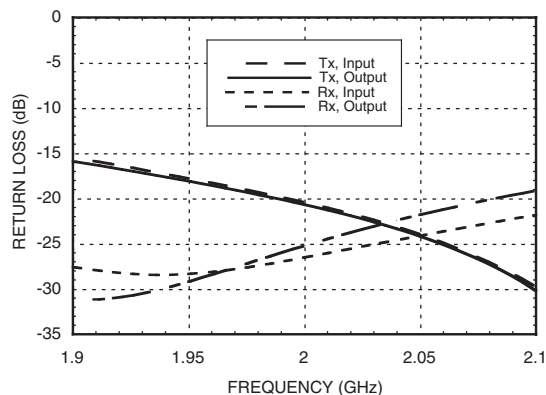

Input IP3 vs. Voltage with 2015 MHz Tuning

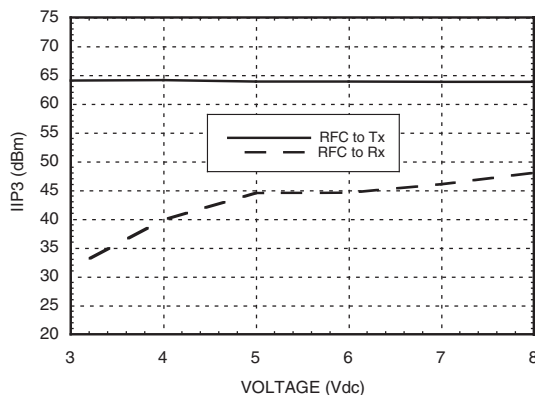



Insertion Loss vs. Temperature, Tx with 2350 MHz Tuning

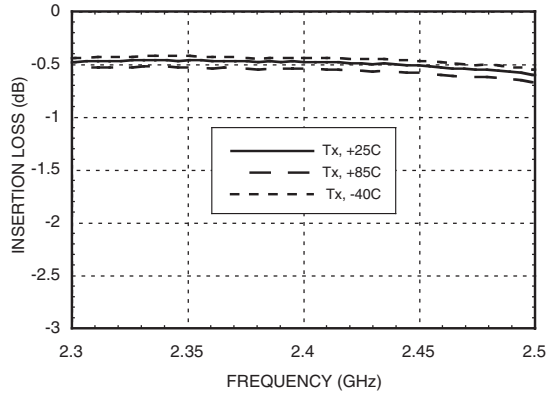

Insertion Loss vs. Temperature, Rx with 2350 MHz Tuning

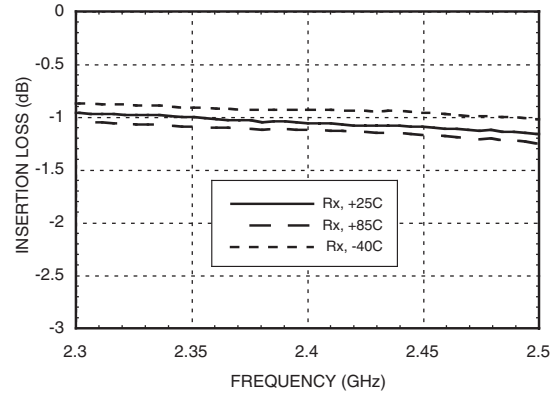

Isolation with 2350 MHz Tuning

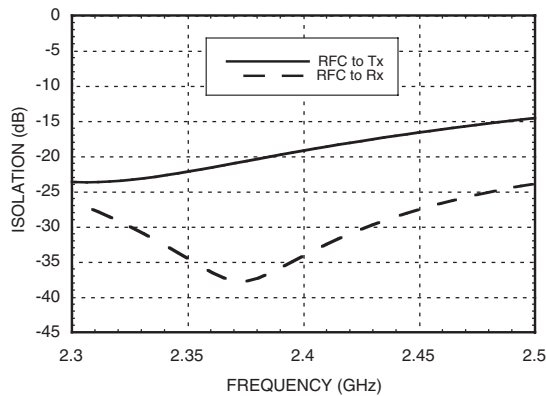

Return Loss with 2350 MHz Tuning

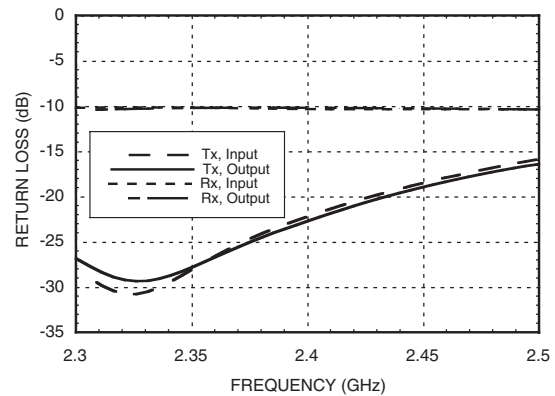

Input IP3 vs. Voltage with 2350 MHz Tuning

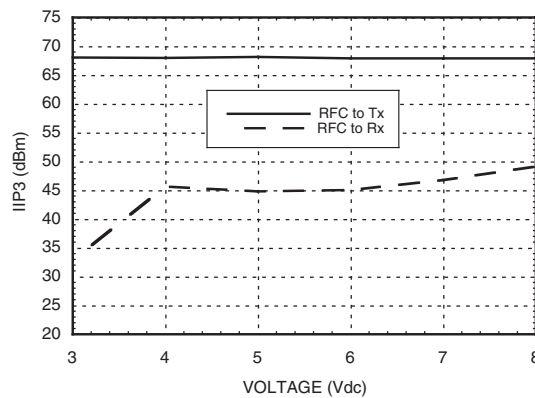



Insertion Loss vs. Temperature, Tx with 2600 MHz Tuning

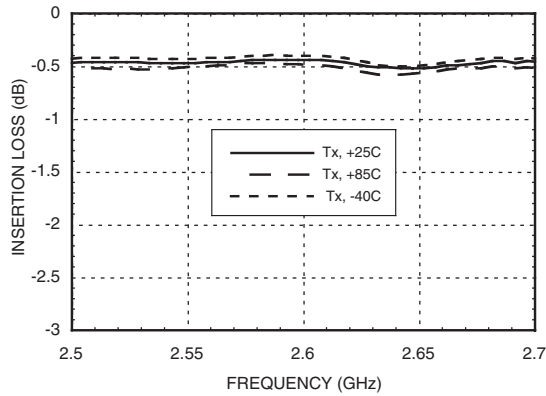

Insertion Loss vs. Temperature, Rx with 2600 MHz Tuning

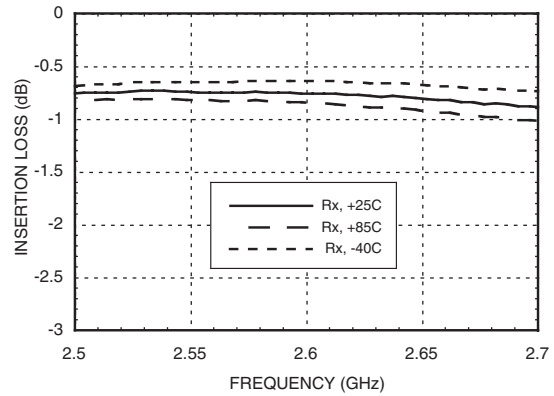

Isolation with 2600 MHz Tuning

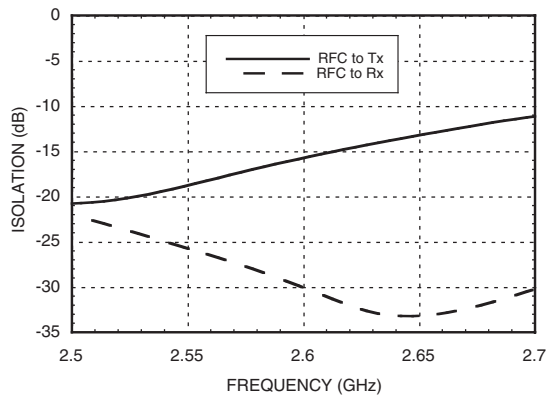

Return Loss with 2600 MHz Tuning

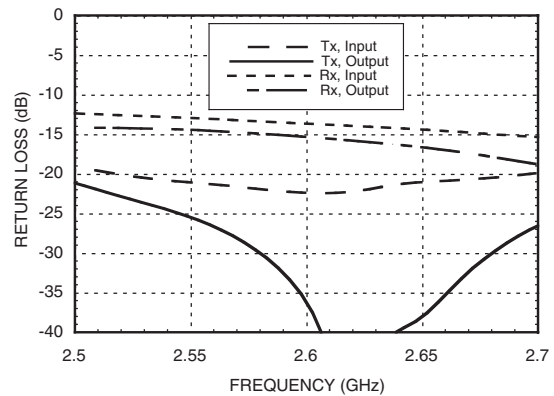

Input IP3 vs. Voltage with 2600 MHz Tuning

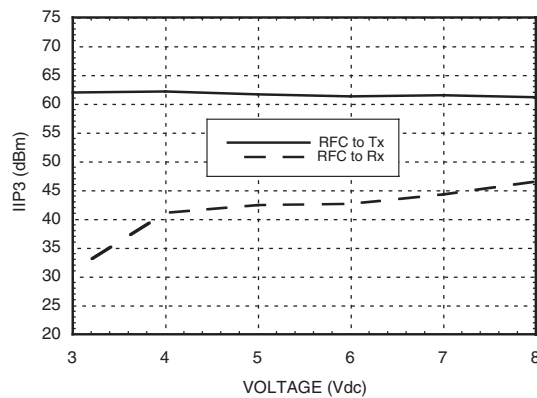

Absolute Maximum Ratings

		3V	5V
Max. CW Input Power	Tx Port	40 dBm	40 dBm
	Rx Port	24 dBm	29 dBm
Max Channel Temp.		150 °C	150 °C
Thermal Resistance	Tx Port	54 °C/W	54 °C/W
	Rx Port	68 °C/W	86 °C/W
Continuous Dissipated Power	Tx Port	1.12 W	1.12 W
	Rx Port	73 mW	232 mW
Supply Voltage (Vdd)		+10 Vdc	
Control Voltage Range (Vctl)		-0.2 to Vdd + 1.0 Vdc	
Storage Temperature		-65 to +150 °C	
Operating Temperature		-40 to +85 °C	
ESD Sensitivity (HBM)		Class 1A	

Truth Table

Control Input		Signal Path State	
Vctl	Vdd	RFC To Tx	RFC to Rx
0.0	Vdd	OFF	ON
Vdd	Vdd	ON	OFF
0	0	ON	OFF
High Z	High Z	ON	OFF

Vdd = +3.0V to +8.0V
Control Input Voltage Tolerances are ± 0.2 Vdc.

DC blocking capacitors are required at ports RFC, Tx and Rx.



**ELECTROSTATIC SENSITIVE DEVICE
OBSERVE HANDLING PRECAUTIONS**

Outline Drawing

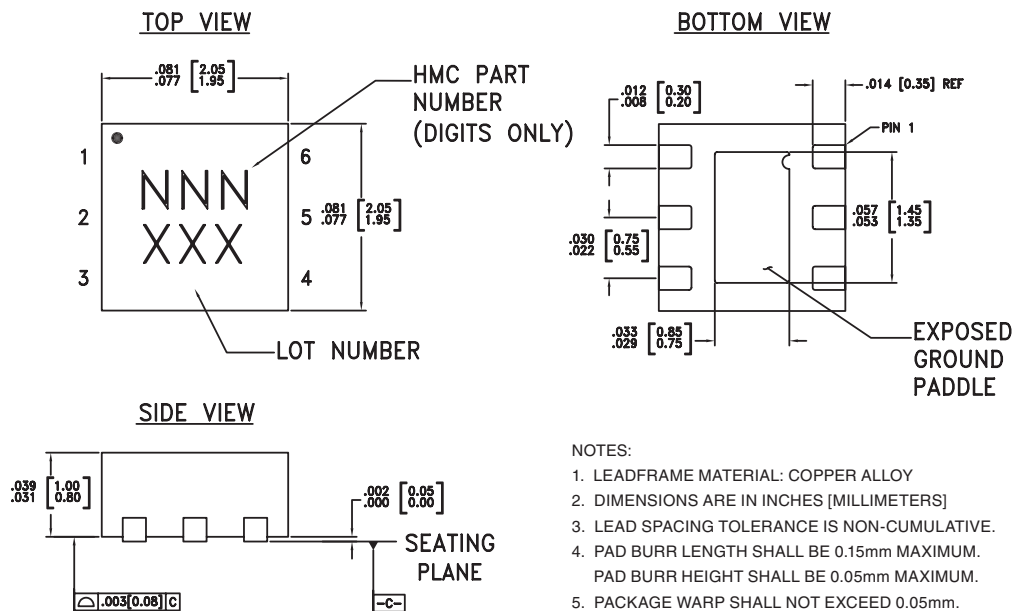

NOTES:

- LEADFRAME MATERIAL: COPPER ALLOY
- DIMENSIONS ARE IN INCHES [MILLIMETERS]
- LEAD SPACING TOLERANCE IS NON-CUMULATIVE.
- PAD BURR LENGTH SHALL BE 0.15mm MAXIMUM. PAD BURR HEIGHT SHALL BE 0.05mm MAXIMUM.
- PACKAGE WARP SHALL NOT EXCEED 0.05mm.
- ALL GROUND LEADS AND GROUND PADDLE MUST BE SOLDERED TO PCB RF GROUND.
- REFER TO HITTITE APPLICATION NOTE FOR SUGGESTED LAND PATTERN.

Package Information

Part Number	Package Body Material	Lead Finish	MSL Rating	Package Marking ^[3]
HMC546LP2	Low Stress Injection Molded Plastic	Sn/Pb Solder	MSL1 ^[1]	546 XXX
HMC546LP2E	RoHS-compliant Low Stress Injection Molded Plastic	100% matte Sn	MSL1 ^[2]	546 XXX

[1] Max peak reflow temperature of 235 °C



[2] Max peak reflow temperature of 260 °C

[3] 4-Digit lot number XXXX

For price, delivery, and to place orders, please contact Hittite Microwave Corporation:
20 Alpha Road, Chelmsford, MA 01824 Phone: 978-250-3343 Fax: 978-250-3373
Order On-line at www.hittite.com

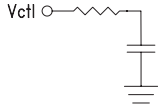
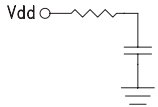

Pin Descriptions

Pin Number	Function	Description	Interface Schematic
1	Tx	This pin is DC coupled and matched to 50 Ohms.	
2	Vctl	See Truth Table.	
3	ACG	External capacitor to ground is required. See application circuit herein.	
4	Rx	This pin is DC coupled and matched to 50 Ohms.	
5	Vdd	Supply Voltage	
6	RFC	This pin is DC coupled and matched to 50 Ohms.	
	GND	Package bottom has exposed metal paddle that must be connected to PCB RF ground.	

Application Circuit

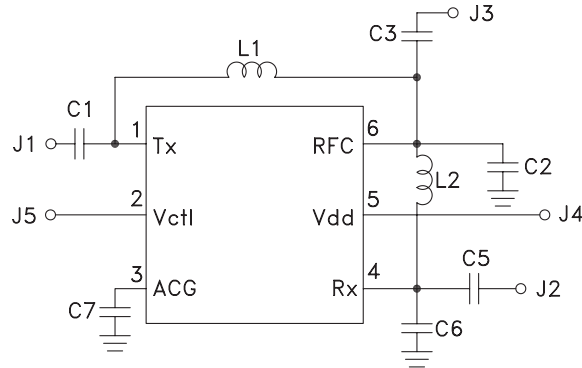

Components for Selected Frequencies

Tuned Frequency	1843 MHz	2015 MHz	2350 MHz	2600 MHz
Evaluation PCB Number	110782	115201	115202	115203
C1, C3, C5 [1]	330 pF	330 pF	330 pF	330 pF
C2 [2]	1.2 pF	0.8 pF	1.2 pF	0.7 pF
C6 [2]	0.5 pF	N/A	N/A	N/A
C7 [2]	3.0 pF	2.4 pF	2.0 pF	1.5 pF
L1	5.1nH [4]	4.3 nH [4]	2.0 nH [4]	1.6 nH [3]
L2 [4]	4.3 nH	3.9 nH	2.4 nH	2.7 nH

[1] DC blocking capacitors

[2] ATC 0402 capacitors

[3] Coilcraft 0603 inductor, 5% tolerance

[4] Coilcraft 0402 inductor, 5% tolerance

Evaluation PCB

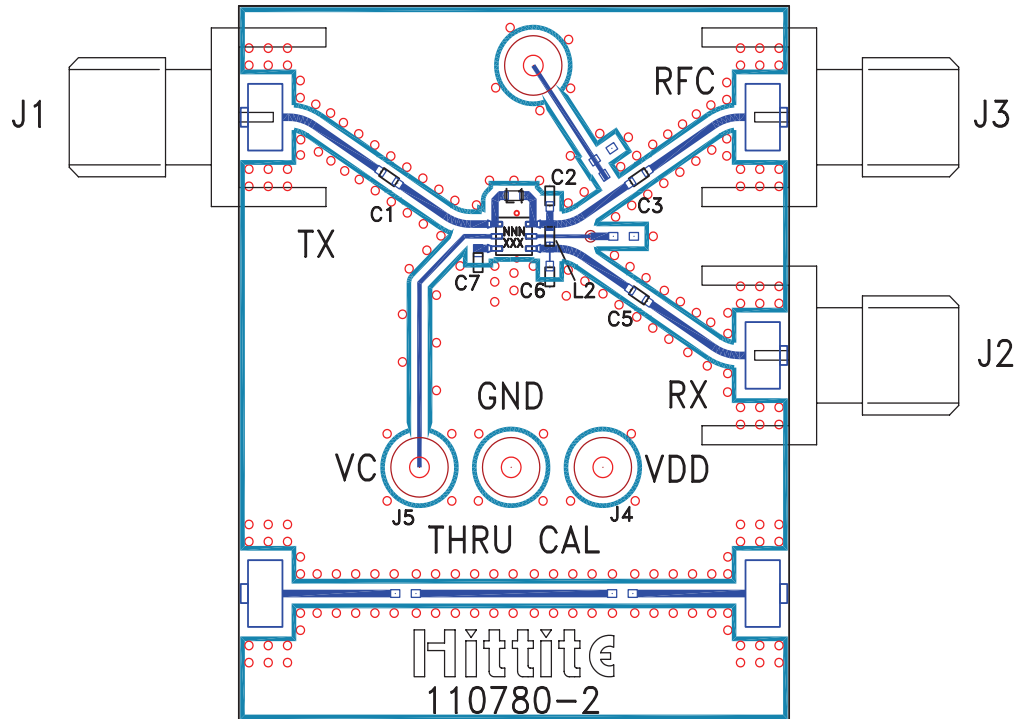

List of Materials for Evaluation PCB ^[1]

Item	Description
J1 - J3	PCB Mount SMA RF Connector
J4 - J6	DC Pin
C1 - C3 [2]	Capacitor, 0402 Pkg.
L1 - L2 [2]	Inductor, 0402 or LP2 0603 Pkg.
U1	HMC546LP2 / HMC546LP2E T/R Switch
PCB [3]	108992 Evaluation PCB

[1] When requesting an evaluation board, please reference the appropriate evaluation PCB number listed in the table "Components for Selected Frequencies."

[2] Please refer to 'Components for Selected Frequencies' table for values.

[3] Circuit Board Material: Rogers 4350

The circuit board used in the final application should be generated with proper RF circuit design techniques. Signal lines at the RF port should have 50 ohm impedance and the package ground leads and exposed paddle should be connected directly to the ground plane similar to that shown above. The evaluation circuit board shown above is available from Hittite Microwave Corporation upon request.



MICROWAVE CORPORATION v00.0506



HMC546LP2 / 546LP2E

GaAs MMIC 10W FAILSAFE SWITCH

0.2 - 2.7 GHz

Notes:



SWITCHES - SMT

For price, delivery, and to place orders, please contact Hittite Microwave Corporation:
20 Alpha Road, Chelmsford, MA 01824 Phone: 978-250-3343 Fax: 978-250-3373
Order On-line at www.hittite.com