

HMC540LP3 / 540LP3E

1 dB LSB GaAs MMIC 4-BIT DIGITAL POSITIVE CONTROL ATTENUATOR, DC - 5.5 GHz

Typical Applications

The HMC540LP3 / HMC540LP3E is ideal for both RF and IF applications:

- Cellular Infrastructure
- ISM, MMDS, WLAN, WiMAX, WiBro
- Microwave Radio & VSAT
- Test Equipment and Sensors

Functional Diagram

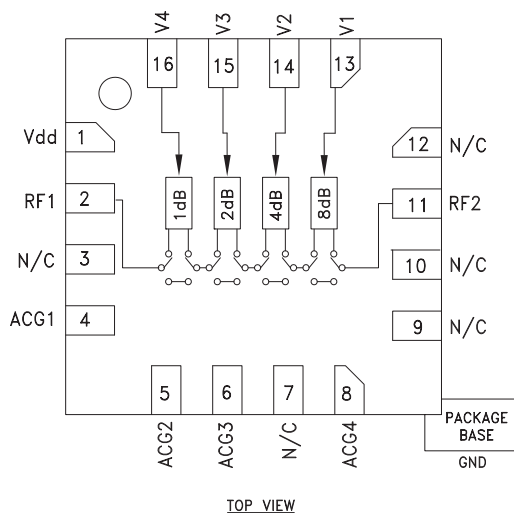

Features

- 1 dB LSB Steps to 15 dB
- ± 0.2 dB Typical Step Error
- Low Insertion Loss: 1 dB
- High IP3: +50 dBm
- Single Control Line Per Bit
- TTL/CMOS Compatible Control
- Single +5V Supply
- 3x3 mm SMT Package

General Description

The HMC540LP3 & HMC540LP3E are broadband 4-bit GaAs IC digital attenuators in low cost leadless surface mount packages. This single positive control line per bit digital attenuator utilizes off chip AC ground capacitors for near DC operation, making it suitable for a wide variety of RF and IF applications. Covering DC to 5.5 GHz, the insertion loss is less than 1 dB typical. The attenuator bit values are 1 (LSB), 2, 4 and 8 dB for a total attenuation of 15 dB. Attenuation accuracy is excellent at ± 0.2 dB typical step error. The attenuator also features a IIP3 of +50 dBm. Four TTL/CMOS control inputs are used to select each attenuation state. A single Vdd bias of +5V is required.

Electrical Specifications,

$T_A = +25^\circ \text{C}$, With $V_{dd} = +5\text{V}$ & $V_{ctl} = 0/+5\text{V}$ (Unless Otherwise Noted)

Parameter	Frequency (GHz)	Min.	Typ.	Max.	Units
Insertion Loss	DC - 2.0 GHz		0.8	1.1	dB
	2.0 - 3.0 GHz		1.0	1.3	dB
	3.0 - 4.0 GHz		1.3	1.6	dB
	4.0 - 5.5 GHz		2.2	2.6	dB
Attenuation Range	DC - 5.5 GHz		15		dB
Return Loss (RF1 & RF2, All Atten. States)	DC - 3.5 GHz		20		dB
	3.5 - 5.5 GHz		15		dB
Attenuation Accuracy: (Referenced to Insertion Loss)	All States	DC - 1.0 GHz	± (0.2 + 2% of Atten. Setting) Max.		dB
		1.0 - 4.0 GHz	± (0.2 + 3% of Atten. Setting) Max.		dB
		4.0 - 5.0 GHz	± (0.3 + 5% of Atten. Setting) Max.		dB
		5.0 - 5.5 GHz	± (0.4 + 8% of Atten. Setting) Max.		dB
Input Power for 0.1 dB Compression	0.1 - 5.5 GHz		27		dBm
Input Third Order Intercept Point (Two-Tone Input Power= 0 dBm Each Tone)	REF - 4 dB States 5 - 15 dB States		50		dBm
			45		dBm
Switching Characteristics	DC - 5.5 GHz				
tRISE, tFALL (10/90% RF)			95		ns
tON, tOFF (50% CTL to 10/90% RF)			100		ns

For price, delivery, and to place orders, please contact Hittite Microwave Corporation:
 20 Alpha Road, Chelmsford, MA 01824 Phone: 978-250-3343 Fax: 978-250-3373
 Order On-line at www.hittite.com

Insertion Loss

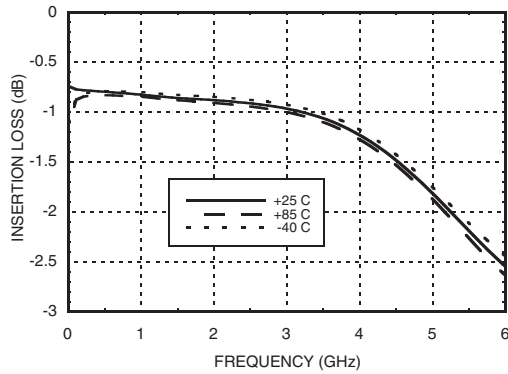

**Return Loss RF1, RF2
(Only Major States are Shown)**

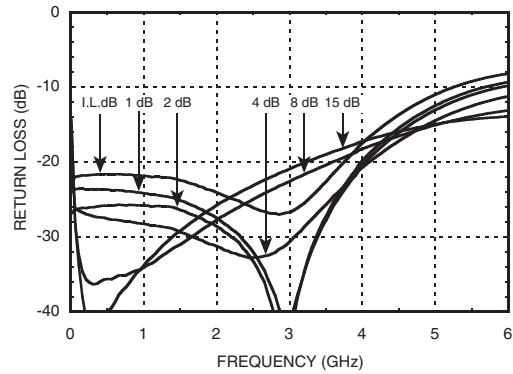

**Normalized Attenuation
(Only Major States are Shown)**

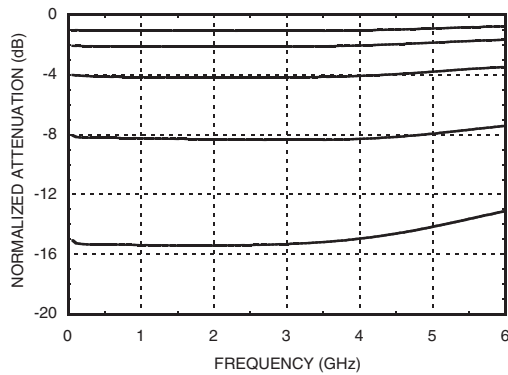

Bit Error vs. Attenuation State

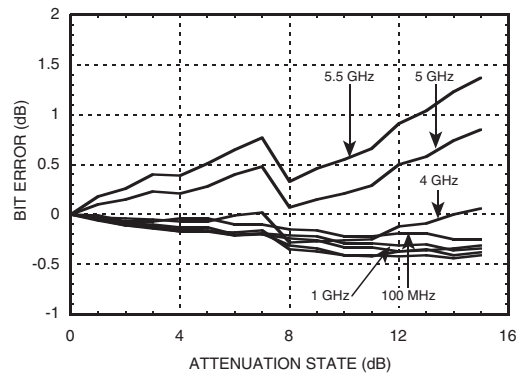

**Bit Error vs. Frequency
(Only Major States are Shown)**

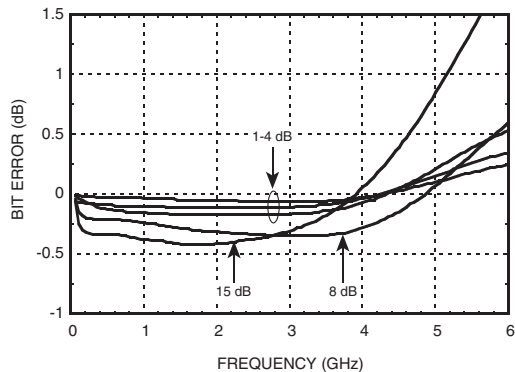

**Relative Phase vs. Frequency
(Only Major States are Shown)**

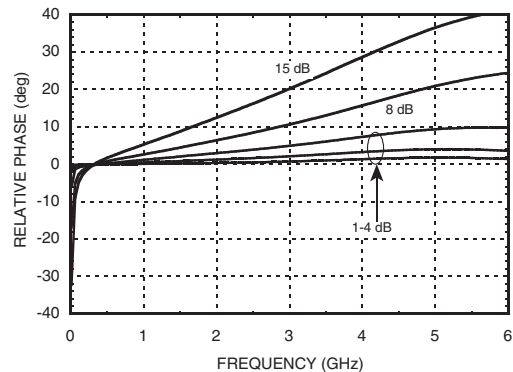

For price, delivery, and to place orders, please contact Hittite Microwave Corporation:
20 Alpha Road, Chelmsford, MA 01824 Phone: 978-250-3343 Fax: 978-250-3373
Order On-line at www.hittite.com



Worst Case Step Error Between Successive Attenuation States

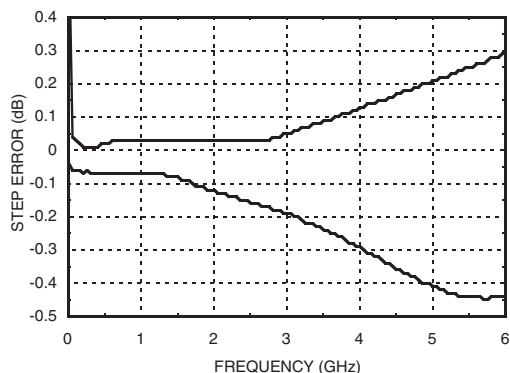

Bias Voltage & Current

Vdd = +5.0 Vdc ± 10%	
Vdd (VDC)	Idd (Typ.) (mA)
+4.5	3.0
+5.0	3.2
+5.5	3.4

Control Voltage

State	Bias Condition
Low	0 to +0.8V @ -5 uA Typ.
High	+2.0 to + 5.0 Vdc @ 40 uA Typ.

Note: Vdd = +5V

Truth Table

Control Voltage Input				Attenuation State RF1 - RF2
V1 8 dB	V2 4 dB	V3 2 dB	V4 1 dB	
High	High	High	High	Reference I.L.
High	High	High	Low	1 dB
High	High	Low	High	2 dB
High	Low	High	High	4 dB
Low	High	High	High	8 dB
Low	Low	Low	Low	15 dB

Any combination of the above states will provide an attenuation approximately equal to the sum of the bits selected.

Absolute Maximum Ratings

RF Input Power (DC - 5.5 GHz)	+29 dBm (T = +85 °C)
Control Voltage Range (V1 to V4)	-1V to Vdd +1V
Bias Voltage (Vdd)	+7.0 Vdc
Channel Temperature	150 °C
Continuous Pdiss (T = 85 °C) (derate 11.7 mW/°C above 85 °C)	0.769 W
Thermal Resistance	85 °C/W
Storage Temperature	-65 to +150 °C
Operating Temperature	-40 to +85 °C



ELECTROSTATIC SENSITIVE DEVICE
OBSERVE HANDLING PRECAUTIONS

Outline Drawing

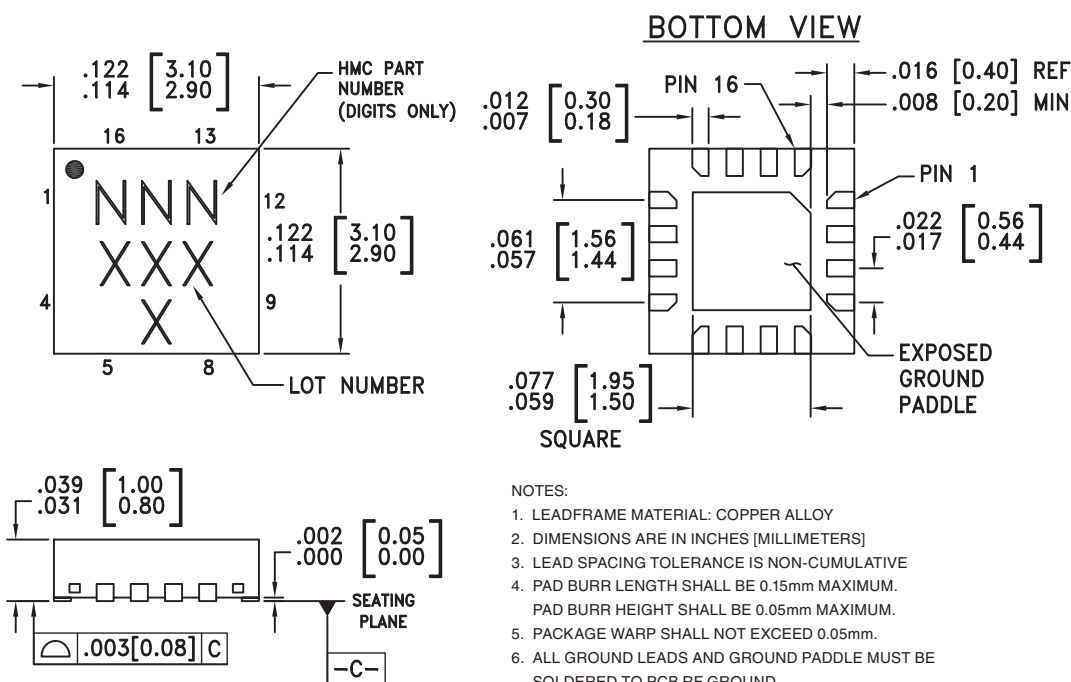

Package Information

Part Number	Package Body Material	Lead Finish	MSL Rating	Package Marking ^[3]
HMC540LP3	Low Stress Injection Molded Plastic	Sn/Pb Solder	MSL1 ^[1]	540 XXXX
HMC540LP3E	RoHS-compliant Low Stress Injection Molded Plastic	100% matte Sn	MSL1 ^[2]	540 XXXX

[1] Max peak reflow temperature of 235 °C



[2] Max peak reflow temperature of 260 °C

[3] 4-Digit lot number XXXX

For price, delivery, and to place orders, please contact Hittite Microwave Corporation:
20 Alpha Road, Chelmsford, MA 01824 Phone: 978-250-3343 Fax: 978-250-3373
Order On-line at www.hittite.com

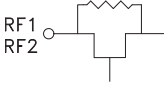
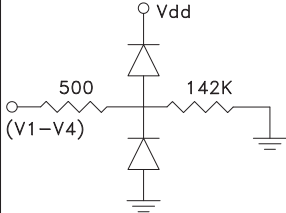

Pin Descriptions

Pin Number	Function	Description	Interface Schematic
1	Vdd	Supply Voltage.	
2, 11	RF1, RF2	This pin is DC coupled and matched to 50 Ohm. Blocking capacitors are required. Select value based on lowest frequency of operation.	
3, 7, 9, 10, 12	N/C	These pins should be connected to PCB RF ground to maximize performance.	
4 - 6, 8	ACG1 - ACG4	External capacitor to ground is required. Select value for lowest frequency of operation. Place capacitor as close to pins as possible.	
13 - 16	V1 - V4	See truth table and control voltage table.	
	GND	Package bottom has an exposed metal paddle that must be connected to RF/DC Ground.	

Application Circuit

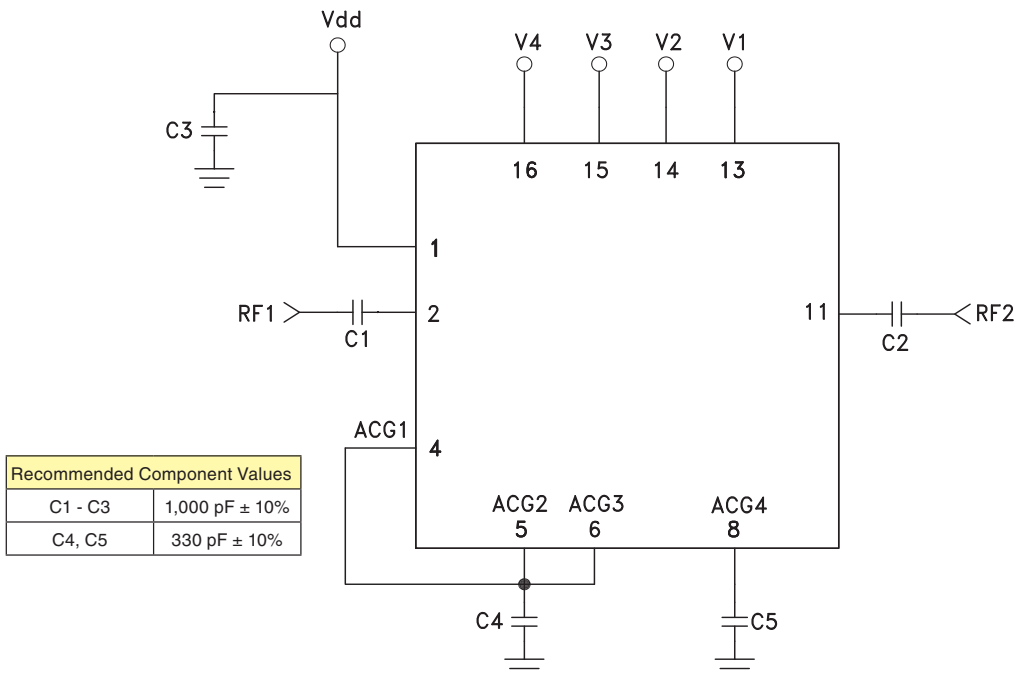

For price, delivery, and to place orders, please contact Hittite Microwave Corporation:
20 Alpha Road, Chelmsford, MA 01824 Phone: 978-250-3343 Fax: 978-250-3373
Order On-line at www.hittite.com

Evaluation PCB

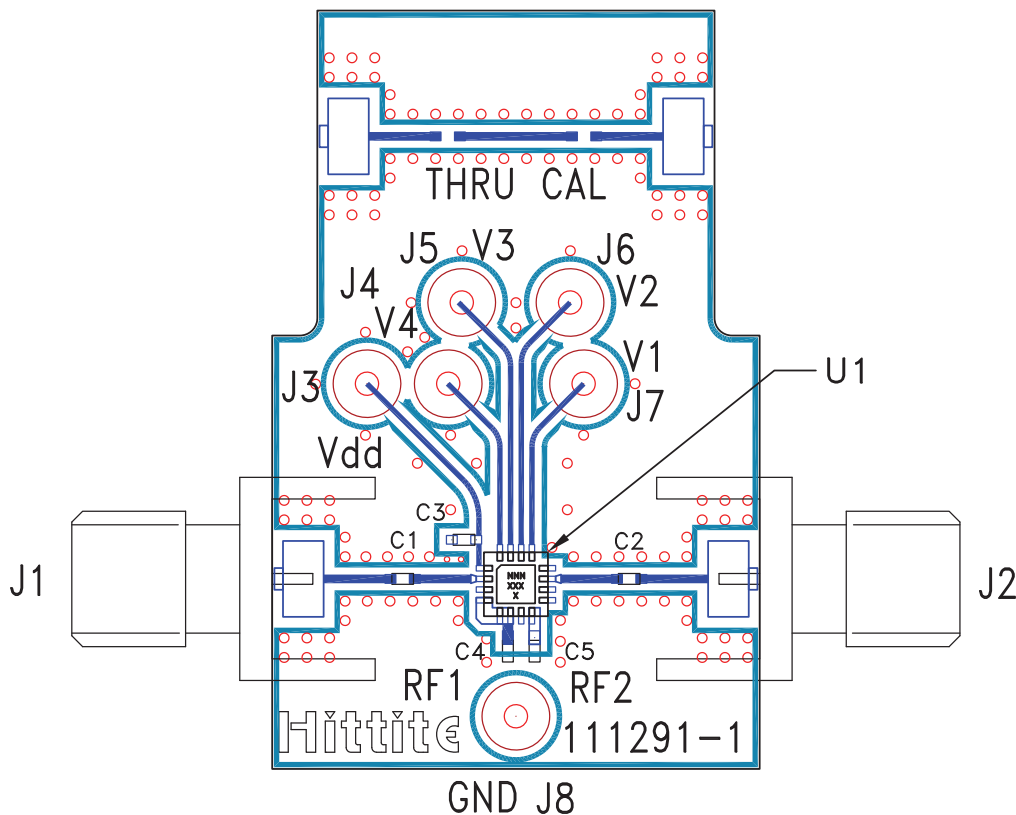

List of Materials for Evaluation PCB 111315 [1]

Item	Description
J1 - J2	PCB Mount SMA Connector
J3 - J8	DC Pin
C1 - C3	1000 pF Capacitor, 0402 Pkg.
C4, C5	330 pF Capacitor, 0402 Pkg.
U1	HMC540LP3 / HMC540LP3E Digital Attenuator
PCB [2]	111291 Evaluation PCB

[1] Reference this number when ordering complete evaluation PCB

[2] Circuit Board Material: Rogers 4350

The circuit board used in the final application should use RF circuit design techniques. Signal lines should have 50 ohm impedance while the package ground leads and exposed paddle should be connected directly to the ground plane similar to that shown. A sufficient number of via holes should be used to connect the top and bottom ground planes. The evaluation circuit board shown is available from Hittite upon request.

For price, delivery, and to place orders, please contact Hittite Microwave Corporation:
 20 Alpha Road, Chelmsford, MA 01824 Phone: 978-250-3343 Fax: 978-250-3373
 Order On-line at www.hittite.com