

Typical Applications

Phase-Locked Oscillator for:

- VSAT Radio
- Point-to-Point & Point-to-Multi-Point Radio
- Test Equipment & Industrial Controls
- Military End-Use

Features

- Pout: +9 dBm
- Phase Noise: -110 dBc/Hz @100 KHz Typ.
- Single Supply: +5V @ 340 mA
+12V @ 28 mA
- QFN Leadless SMT Package, 16 mm²

Functional Diagram

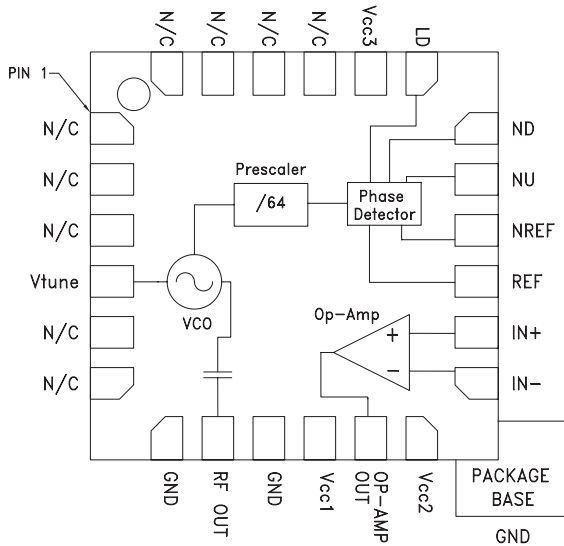

General Description

The HMC535LP4 & HMC535LP4E are GaAs InGaP Heterojunction Bipolar Transistor (HBT) MMIC PLOs. The PLO's phase noise performance is excellent over temperature, shock, and process due to the oscillator's monolithic structure. Power output is +9 dBm typical from a +5V supply voltage. All functions (VCO, Op-Amp, PFD, Prescaler) are fully integrated while providing allowances for off-chip customer specific loop components. The PLO MMIC accepts a single-ended or a differential reference oscillator input signal in the range of 230 to 240 MHz, and a digital Lock Detector (LD) output is provided to confirm the status of the loop. The phase-locked oscillator is packaged in a leadless QFN 4 x 4 mm surface mount package.

Electrical Specifications, $T_A = +25^\circ C$

Parameter	Min.	Typ.	Max.	Units
Power Supplies:				
VCO Voltage	Vcc1	5	—	V
VCO Current	Icc1	172	—	mA
Op-Amp Voltage	Vcc2	12	—	V
Op-Amp Current	Icc2	28	—	mA
Digital Voltage	Vcc3	5	—	V
Digital Current	Icc3	168	—	mA
PLO Characteristics:				
RF Operating Freq.	14.7	—	15.4	GHz
RF Power	6	9	—	dBm
Reference Input Freq.	229.69	—	240.62	MHz
Reference Input Power	0	5	10	dBm
RF Phase Noise	100 KHz offset	-110	—	dBc/Hz
Locking Time	Loop BW = 1 MHz	20	—	μs
Lock Detect Output				
Locked	—	0.3	0.5	V _{ave}
Unlocked	0.7	1.0	—	V _{ave}

For price, delivery, and to place orders, please contact Hittite Microwave Corporation:
20 Alpha Road, Chelmsford, MA 01824 Phone: 978-250-3343 Fax: 978-250-3373
Order On-line at www.hittite.com



Electrical Specifications, (Continued)

Parameter	Min.	Typ.	Max.	Units
VCO Characteristics:				
RF Operating Freq.	14.7	—	15.4	GHz
RF Power	6	9	—	dBm
RF Tuning Sensitivity	$V_{tune} +2 \text{ to } +9.5 \text{ V}$	160	—	MHz/V
	$V_{tune} 0 \text{ to } +2 \text{ V}$	—	590	MHz/V
	$V_{tune} +9.5 \text{ to } +12 \text{ V}$	—	—	MHz/V
Tuning Voltage Leakage Current	$V_{tune} +2 \text{ to } +9.5 \text{ V}$	—	25	μA
RF Phase Noise	100 kHz offset	-108	—	dBc/Hz
RF Harmonics	$1/2 F_{OP}$	—	-20	dBc
	$3/2 F_{OP}$	—	-35	dBc
	$4/2 F_{OP}$	—	-8	dBc
	$5/2 F_{OP}$	—	-25	dBc
RF Pushing	—	—	-125	MHz/V
RF Pulling	VSWR 2:1 any phase	—	10	MHz
RF Drift Rate	$V_{T_{VCO}}$ input	—	20	MHz/°C
3 dB Modulator Bandwidth	30	—	—	MHz
Phase Frequency Detector:				
REF Input Capacitance	—	—	10	pF
REF Input Resistance	—	50	—	Ohm
REF Input VSWR	Referenced to 50 Ohms	—	2:1	—
Output High Voltage	—	V_{CC3}	—	V
Output Low Voltage	$V_{CC3} -1.9$	$V_{CC3} -1.95$	$V_{CC3} -2$	V
Phase Noise	—	-150	—	dBc/Hz
Op-Amp Characteristics:				
Input Offset Voltage	$V_{CM} = 2.5\text{V}, 5.2\text{V}$	1	—	mV
Input bias Current	$V_{CM} = 2.5\text{V}, 5.2\text{V}$	5	—	μA
Large-Signal Voltage Gain	Open Loop, No Load	69	—	dB
Common Mode Rejection Ratio	$V_{CM} = 2.5\text{V}$ Frequency = 1 MHz	104	—	dB
Input Common Mode Range	—	2.5	—	V
Power Supply Rejection Ratio	$V_{CM} = 2.5\text{V}$ Frequency = 1 MHz	—	63	dB
Output Voltage Swing Low	No Load, $I_{SINK} = 5 \text{ mA}$	—	0.8	V
		—	0.81	V
Output Voltage Swing High	No Load, $I_{SOURCE} = 5 \text{ mA}$	10	10.5	V
		10	10.2	V
Gain Bandwidth Product	Frequency = 6 MHz	—	400	MHz
Slew Rate	$A_V = 10$, No Load $V_O = 10\text{V}$	—	146	V/ μs
Phase Margin	Open Loop	—	110	Deg
Input Voltage Noise	Frequency = 10 kHz	—	1.6	nV / sqrt (Hz)
Prescaler (Divider) Characteristics:				
Prescaler Division	—	64	—	—
Phase Noise	—	-156	—	dBc/Hz



PLO Performance Plots

Reference Spurs @ 15 GHz
BW = 1 MHz, Ref. Frequency = 234 MHz

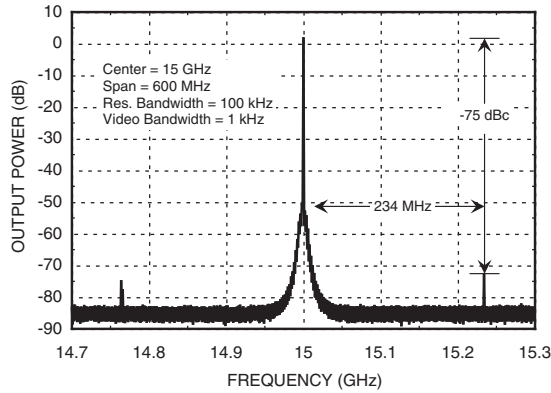

15 GHz Locked RF Signal
BW = 1 MHz, Ref. Frequency = 234 MHz

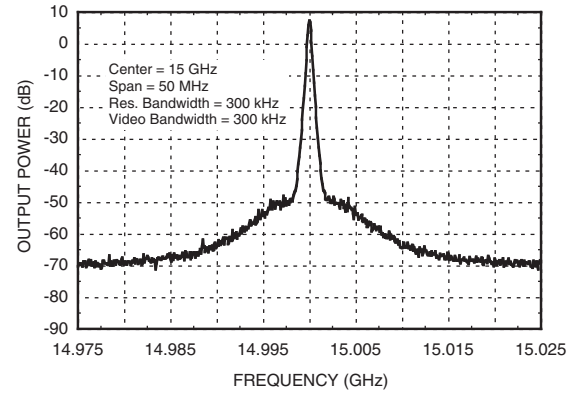

Phase Noise Performance

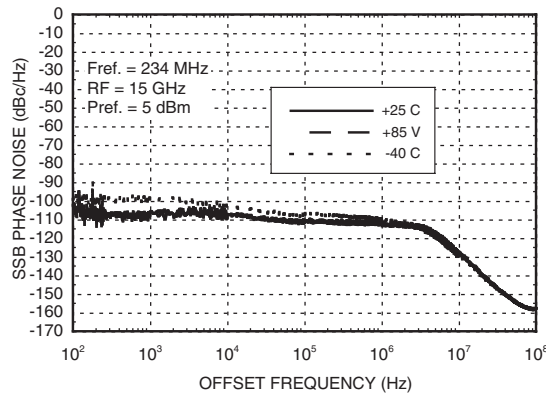

VCO Performance Plots

Frequency vs. Tuning Voltage, T = 25°C

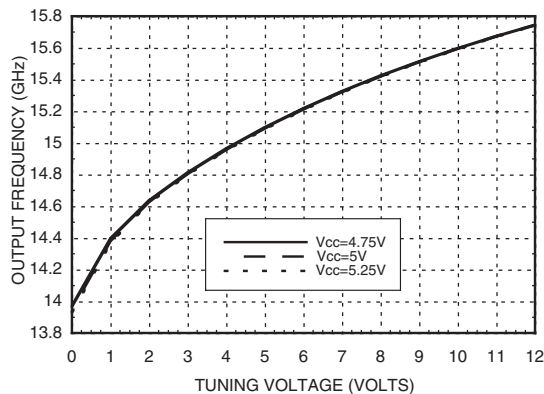

Frequency vs. Tuning Voltage, Vcc1 = +5V

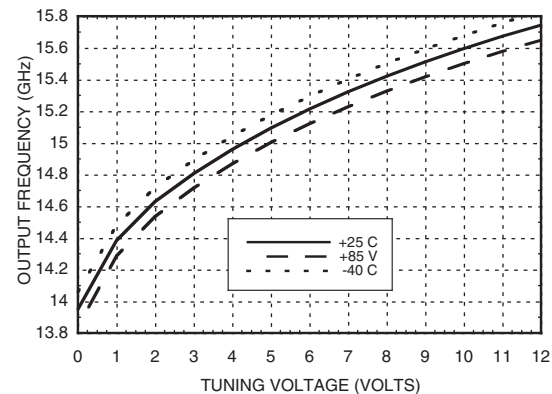

For price, delivery, and to place orders, please contact Hittite Microwave Corporation:
20 Alpha Road, Chelmsford, MA 01824 Phone: 978-250-3343 Fax: 978-250-3373
Order On-line at www.hittite.com

VCO Performance Plots (continued)

Sensitivity vs. Tuning Voltage, Vcc1 = +5V

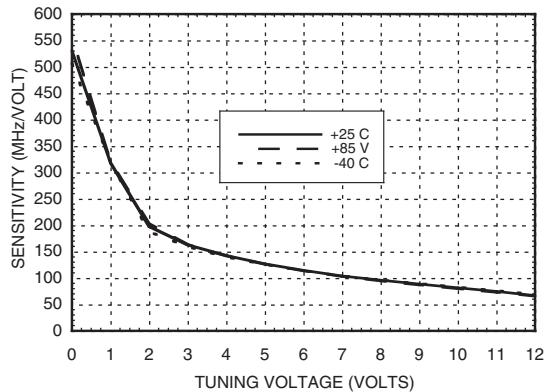

Output Power vs. Tuning Voltage, Vcc1 = +5V

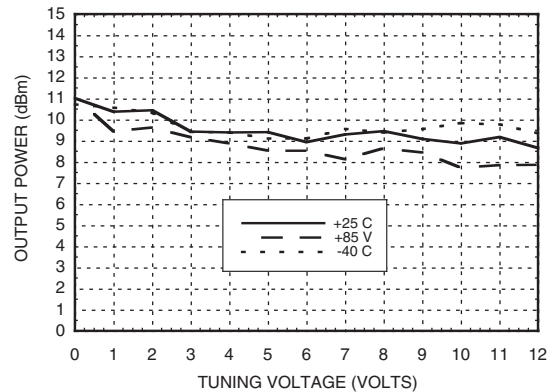

SSB Phase Noise vs. Tuning Voltage

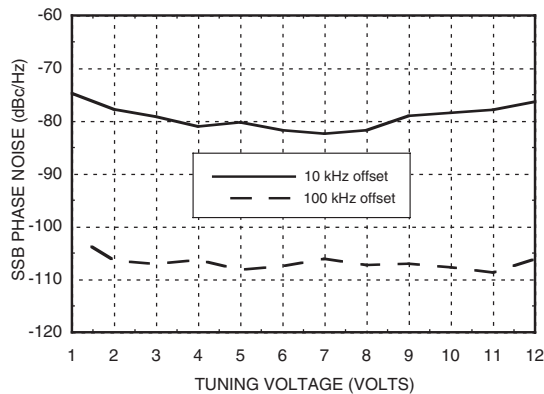

SSB Phase Noise @ Vtune = +5V

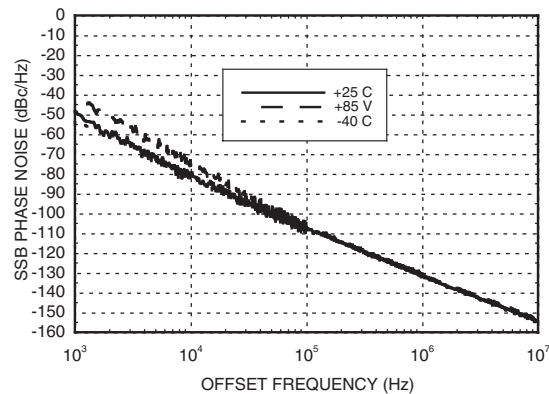

Phase-Frequency Detector Performance Plots

Error Voltage vs. Temperature
Pin = 0 dBm, Fin = 235 MHz

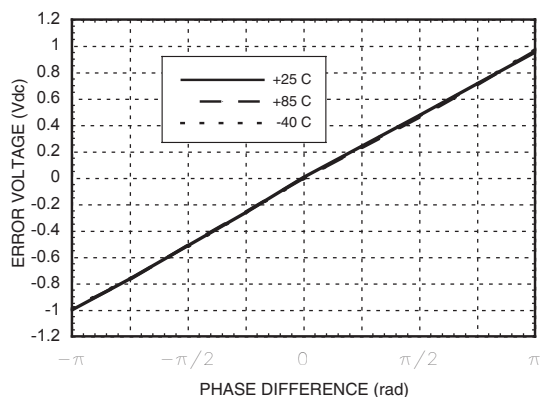

SSB Phase Noise Performance
Pin = 0 dBm, T = 25°C

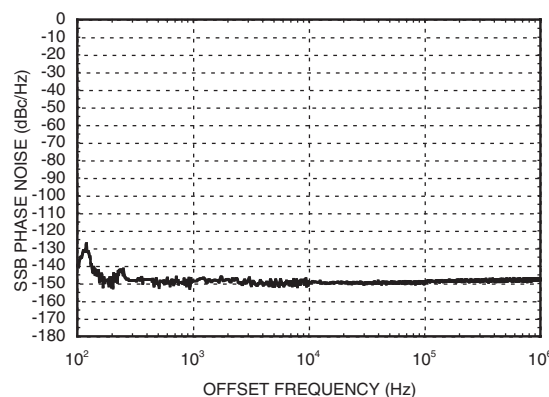

For price, delivery, and to place orders, please contact Hittite Microwave Corporation:
20 Alpha Road, Chelmsford, MA 01824 Phone: 978-250-3343 Fax: 978-250-3373
Order On-line at www.hittite.com

Absolute Maximum Ratings

Vcc1	+5.5 Vdc
Vcc2	+13 Vdc
Vcc3	+5.5 Vdc
Reference Input Power	+13 dBm
Vtune	0 to +13V
Channel Temperature	135 °C
Continuous P _{diss} (T = 85°C) (derate 47 mW/°C above 85°C)	2.35 W
Storage Temperature	-55 to +125 °C
Operating Temperature	-40 to +85 °C

Typical Supply Currents vs. Voltages @ 15 GHz Output

Vcc1 (V)	Icc1 (mA)
4.75	156
5.0	172
5.25	185
Vcc2 (V)	Icc2 (mA)
11.5	26
12	28
12.5	30
Vcc3 (V)	Icc3 (mA)
4.75	158
5	168
5.25	180



**ELECTROSTATIC SENSITIVE DEVICE
OBSERVE HANDLING PRECAUTIONS**

Outline Drawing

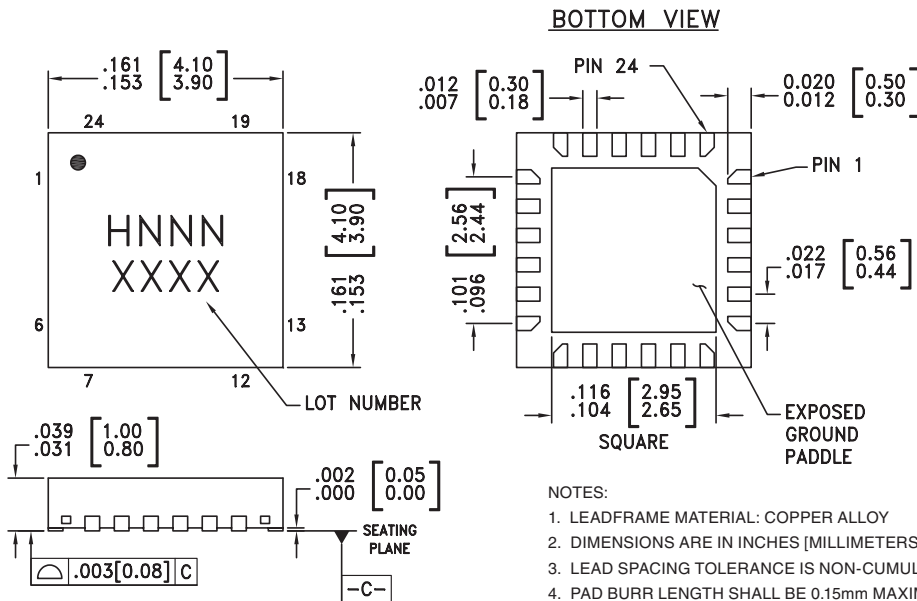

NOTES:

- LEADFRAME MATERIAL: COPPER ALLOY
- DIMENSIONS ARE IN INCHES [MILLIMETERS]
- LEAD SPACING TOLERANCE IS NON-CUMULATIVE.
- PAD BURR LENGTH SHALL BE 0.15mm MAXIMUM.
PAD BURR HEIGHT SHALL BE 0.05mm MAXIMUM.
- PACKAGE WARP SHALL NOT EXCEED 0.05mm.
- ALL GROUND LEADS AND GROUND PADDLE MUST BE SOLDERED TO PCB RF GROUND.
- REFER TO HITTITE APPLICATION NOTE FOR SUGGESTED LAND PATTERN.

Package Information

Part Number	Package Body Material	Lead Finish	MSL Rating	Package Marking ^[3]
HMC535LP4	Low Stress Injection Molded Plastic	Sn/Pb Solder	MSL1 ^[1]	H535 XXXX
HMC535LP4E	RoHS-compliant Low Stress Injection Molded Plastic	100% matte Sn	MSL1 ^[2]	H535 XXXX

[1] Max peak reflow temperature of 235 °C



[2] Max peak reflow temperature of 260 °C

[3] 4-Digit lot number XXXX



For price, delivery, and to place orders, please contact Hittite Microwave Corporation:
20 Alpha Road, Chelmsford, MA 01824 Phone: 978-250-3343 Fax: 978-250-3373
Order On-line at www.hittite.com

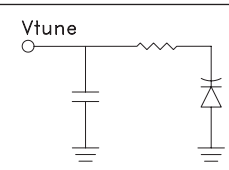

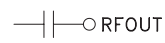
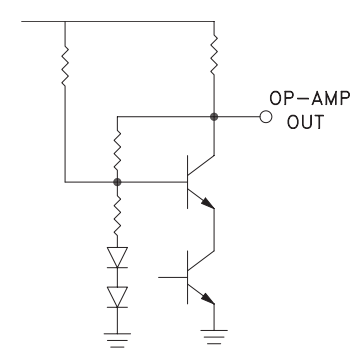
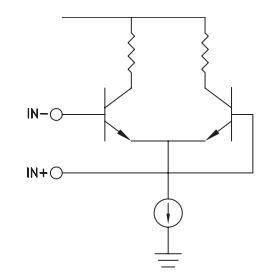
Pin Descriptions

Pin Number	Function	Description	Interface Schematic
1-3, 5, 6, 21-24	N/C	No Connection. These pins may be connected to RF/DC ground. Performance will not be affected.	
4	Vtune	VCO control voltage input.	
7, 9	GND	This pin must be connected to RF / DC ground.	
8	RFOUT	RF output (AC coupled).	
10	Vcc1	VCO Supply Voltage, +5V.	
11	OP-AMP OUT	Op-Amp output voltage.	
12	Vcc2	Op-amp Supply Voltage, +12V.	
13	IN-	Op-amp negative input voltage.	
14	IN+	Op-amp positive input voltage.	

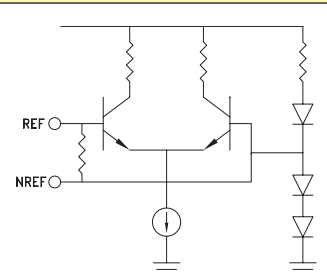
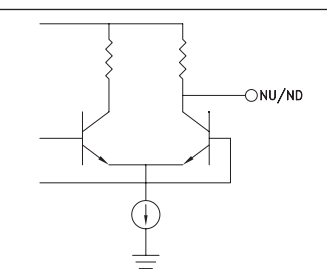
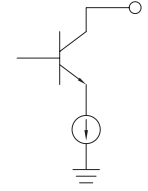
Pin Descriptions (Continued)

Pin Number	Function	Description	Interface Schematic
15	REF	PFD reference input. (This pin must be DC blocked externally)	
16	NREF	PFD reference input compliment. (This pin must be DC blocked externally)	
17	NU	PFD not up output.	
18	ND	PFD not down output.	
19	LD	PFD lock detector output.	
20	Vcc3	Digital circuitry supply voltage, +5V.	
Package Base	GND	Package bottom has an exposed metal paddle that must be connected to RF / DC ground.	



Application Circuit

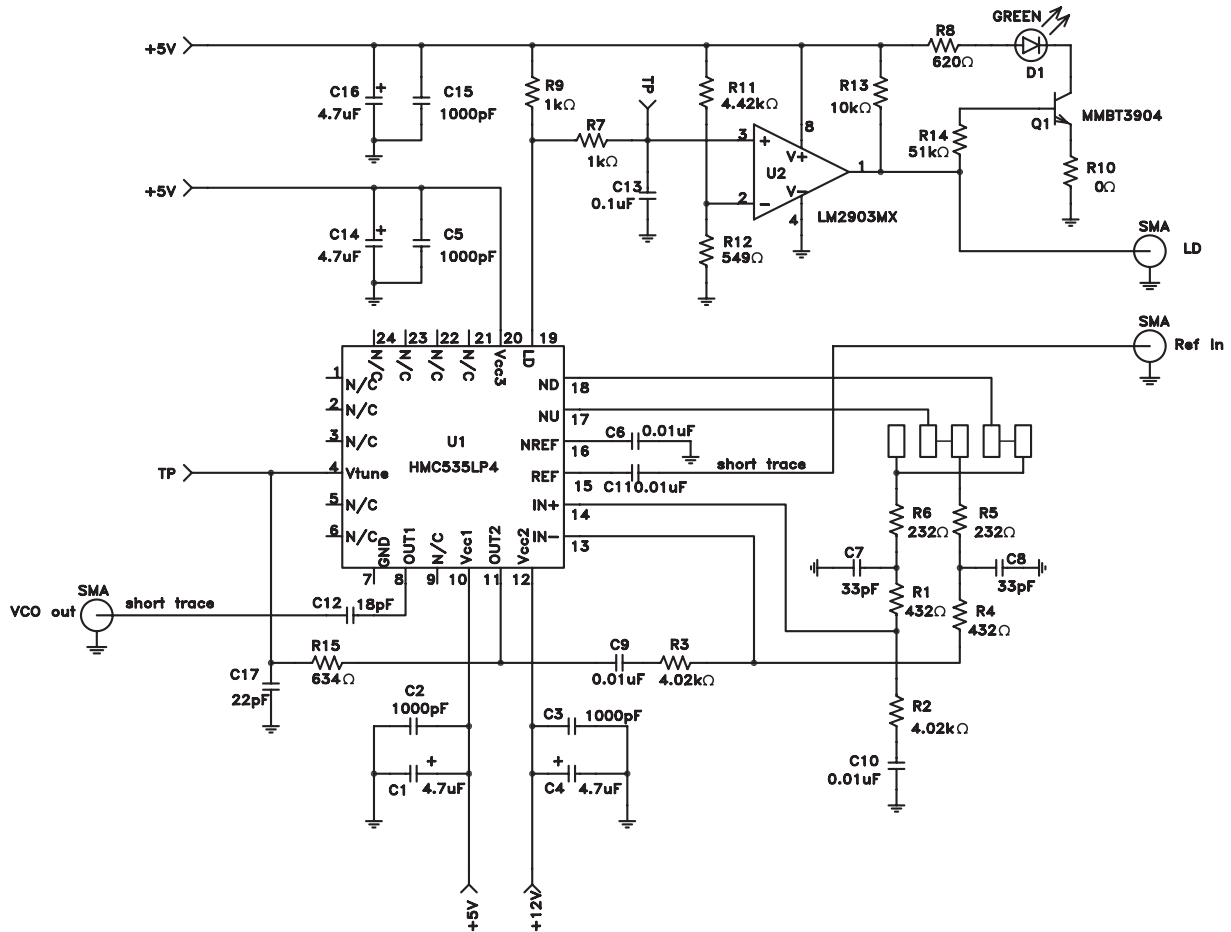

For price, delivery, and to place orders, please contact Hittite Microwave Corporation:
20 Alpha Road, Chelmsford, MA 01824 Phone: 978-250-3343 Fax: 978-250-3373
Order On-line at www.hittite.com

Evaluation PCB

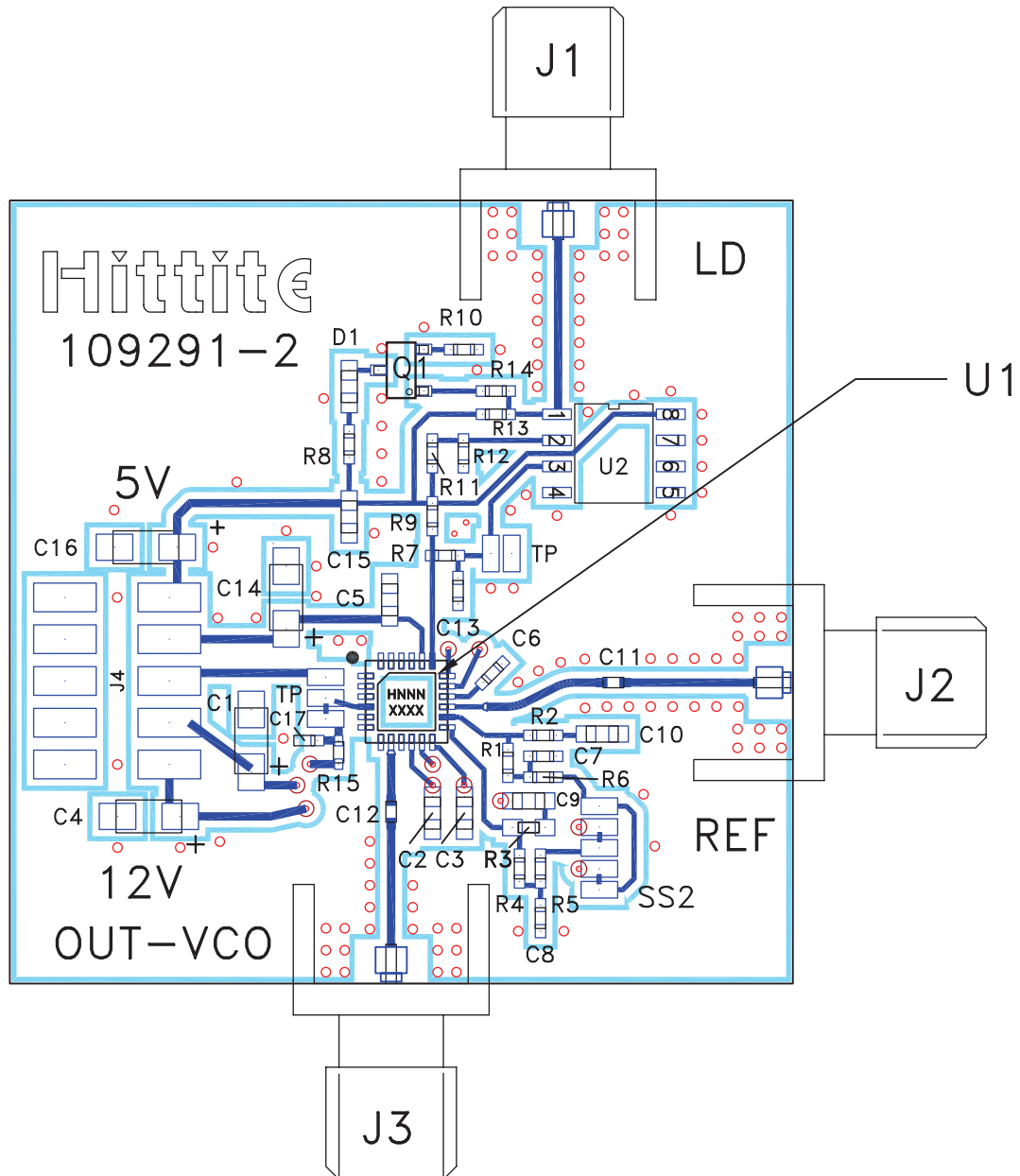

The circuit board used in the final application should use RF circuit design techniques. Signal lines should have 50 ohm impedance while the package ground leads and backside ground paddle should be connected directly to the ground plane similar to that shown. A sufficient number of via holes should be used to connect the top and bottom ground planes. The evaluation board should be mounted to an appropriate heat sink. The evaluation circuit board shown is available from Hittite upon request.

For price, delivery, and to place orders, please contact Hittite Microwave Corporation:
20 Alpha Road, Chelmsford, MA 01824 Phone: 978-250-3343 Fax: 978-250-3373
Order On-line at www.hittite.com



List of Materials for Evaluation PCB 109293 [1]

Item	Description
J1 - J3	PCB Mount SMA RF Connector
J4	DC Pin
C1, C4, C14, C16	4.7 μ F Tantalum Capacitor
C2, C3, C5, C15	1,000 pF Capacitor, 0603 Pkg.
C6, C11	0.01 μ F Capacitor, 0402 Pkg.
C7, C8	33 pF Capacitor, 0402 Pkg.
C9, C10	0.01 μ F Capacitor, 0603 Pkg.
C12	18 pF Capacitor, 0402 Pkg.
C13	0.1 μ F Capacitor, 0402 Pkg.
C17	22 pF Capacitor, 0402 Pkg.
R1, R4	432 Ohm Resistor, 0402 Pkg.
R2, R3	4.02 k Ohm Resistor, 0402 Pkg.
R5, R6	232 Ohm Resistor, 0402 Pkg.
R7, R9	1k Ohm Resistor, 0402 Pkg.
R8	620 Ohm Resistor, 0402 Pkg.
R10	0 Ohm Resistor, 0402 Pkg.
R11	4.42 k Ohm Resistor, 0402 Pkg.
R12	549 Ohm Resistor, 0402 Pkg.
R13	10 k Ohm Resistor, 0402 Pkg.
R14	51 k Ohm Resistor, 0402 Pkg.
R15	634 Ohm Resistor, 0402 Pkg.
D1	Green LED, 0603 Pkg.
Q1	MMBT3904, SOT26 Pkg.
U1	HMC535LP4 / HMC535LP4E PLO
U2	LM2903MX
PCB [2]	109291 Eval Board

[1] Reference this number when ordering complete evaluation PCB

[2] Circuit Board Material: Rogers 4350