



Typical Applications

Low noise MMIC VCO w/Half Frequency, Divide-by-4 Outputs for:

- VSAT Radio
- Point to Point/Multipoint Radio
- Test Equipment & Industrial Controls
- Military End-Use

Features

- Dual Output: $F_o = 11.17 - 12.02$ GHz
 $F_o/2 = 5.58 - 6.01$ GHz
- Pout: +7 dBm
- Phase Noise: -110 dBc/Hz @100 KHz Typ.
- No External Resonator Needed
- QFN Leadless SMT Package, 25 mm²

Functional Diagram

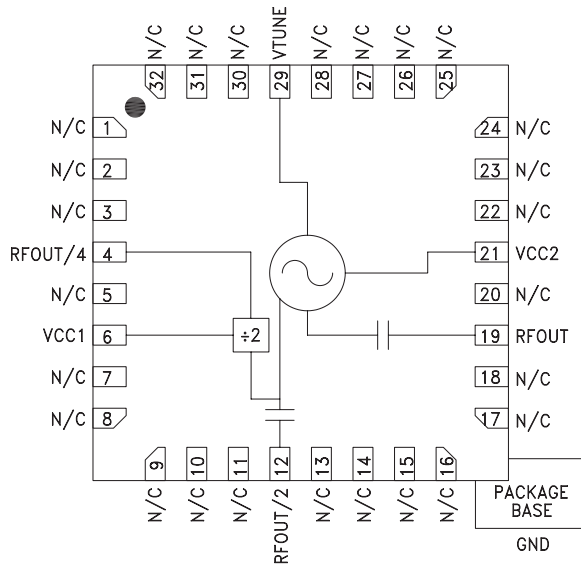

General Description

The HMC514LP5 & HMC514LP5E are GaAs InGaP Heterojunction Bipolar Transistor (HBT) MMIC VCOs. The HMC514LP5 & HMC514LP5E integrate resonators, negative resistance devices, varactor diodes and feature half frequency and divide-by-4 outputs. The VCO's phase noise performance is excellent over temperature, shock, and process due to the oscillator's monolithic structure. Power output is +7 dBm typical from a +3V supply voltage. The prescaler function can be disabled to conserve current if not required. The voltage controlled oscillator is packaged in a leadless QFN 5x5 mm surface mount package, and requires no external matching components.

Electrical Specifications, $T_A = +25^\circ C$, $V_{cc1}, V_{cc2} = +3V$

Parameter	Min.	Typ.	Max.	Units	
Frequency Range	F_o $F_o/2$	11.17 - 12.02 5.585 - 6.01		GHz GHz	
Power Output	RFOUT RFOUT/2 RFOUT/4	+5 +5 -10	+10 +11 -4	dBm dBm dBm	
SSB Phase Noise @ 100 kHz Offset, $V_{tune} = +5V$ @ RFOUT		-110		dBc/Hz	
Tune Voltage	V_{tune}	2	13	V	
Supply Current	I_{cc1} & I_{cc2}	240	275	290	mA
Tune Port Leakage Current ($V_{tune} = 13V$)			10	μA	
Output Return Loss		2		dB	
Harmonics/Subharmonics	1/2 3/2 2nd 3rd		30 24 17 28	dBc dBc dBc dBc	
Pulling (into a 2.0:1 VSWR)		4		MHz/pp	
Pushing @ $V_{tune} = 5V$		18		MHz/V	
Frequency Drift Rate		1.2		MHz/ $^\circ C$	

For price, delivery, and to place orders, please contact Hittite Microwave Corporation:
20 Alpha Road, Chelmsford, MA 01824 Phone: 978-250-3343 Fax: 978-250-3373
Order On-line at www.hittite.com

Frequency vs. Tuning Voltage, T= 25°C

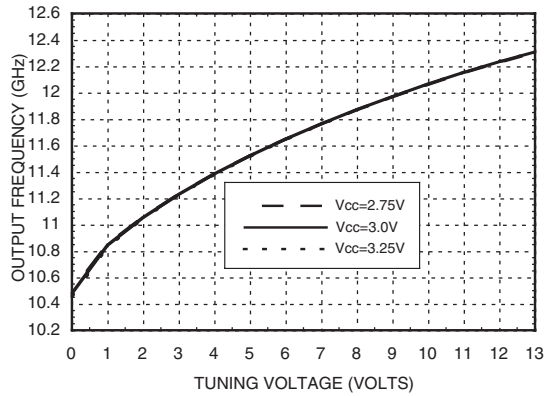

Frequency vs. Tuning Voltage, Vcc= +3V

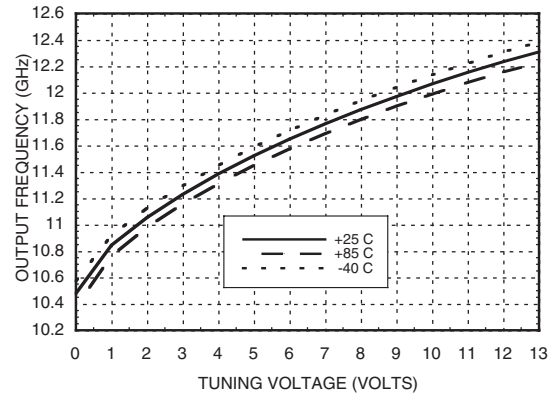

Sensitivity vs. Tuning Voltage, Vcc= +3V

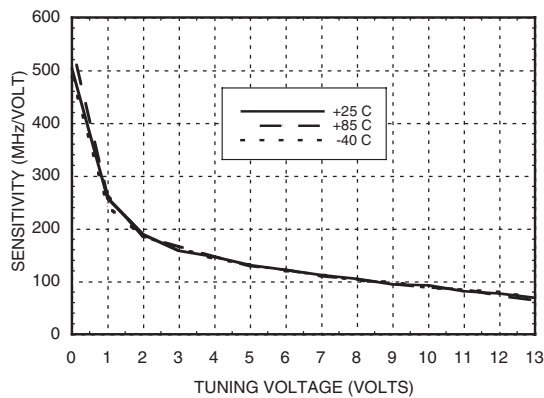

Output Power vs. Tuning Voltage, Vcc= +3V

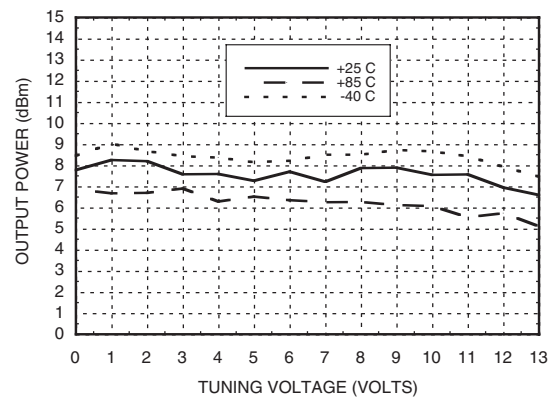

SSB Phase Noise vs. Tuning Voltage

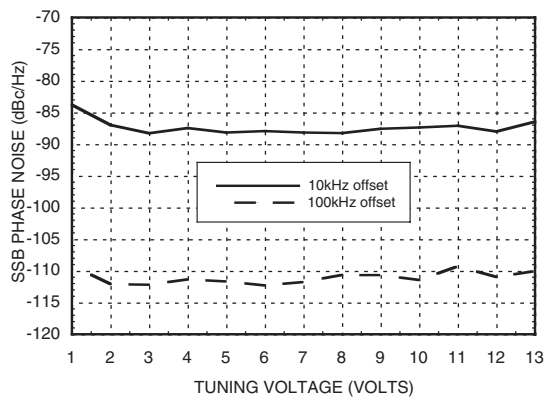

SSB Phase Noise @ Vtune= +5V

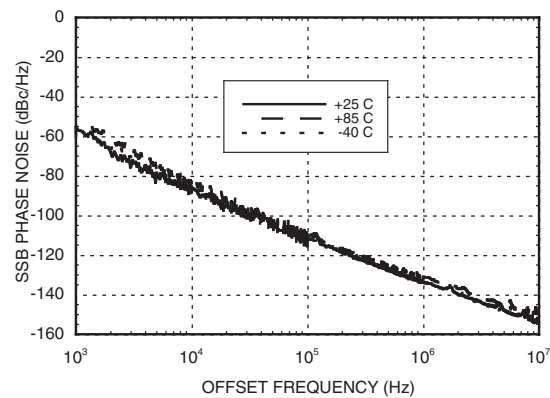

For price, delivery, and to place orders, please contact Hittite Microwave Corporation:
 20 Alpha Road, Chelmsford, MA 01824 Phone: 978-250-3343 Fax: 978-250-3373
 Order On-line at www.hittite.com



**MMIC VCO w/ HALF FREQUENCY OUTPUT
& DIVIDE-BY-4, 11.17 - 12.02 GHz**

**RFOUT/2 Frequency
vs. Tuning Voltage, Vcc= +3V**

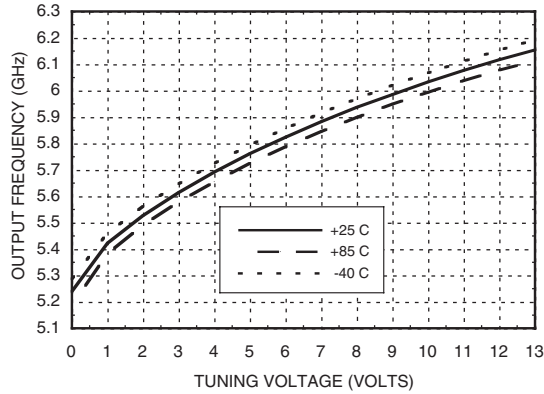

**RFOUT/2 Output Power
vs. Tuning Voltage, Vcc= +3V**

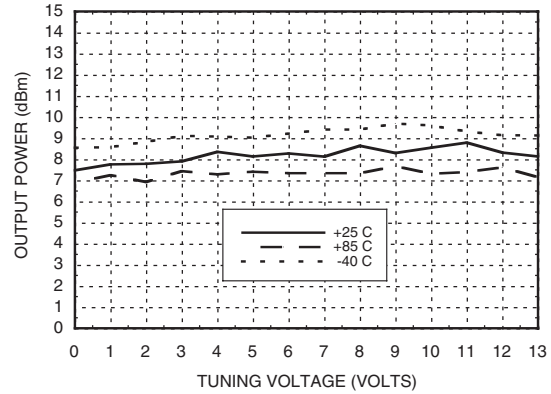

**Divide-by-4 Frequency
vs. Tuning Voltage, Vcc= +3V**

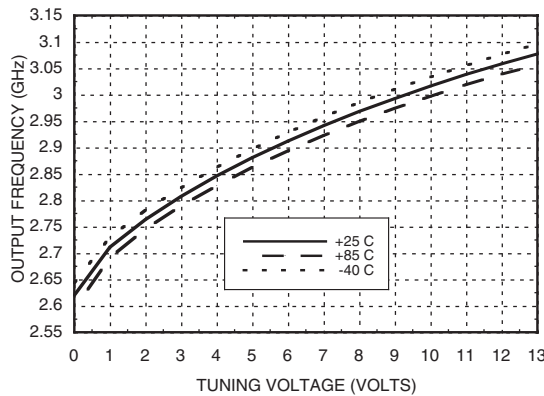

**Divide-by-4 Output Power
vs. Tuning Voltage, Vcc= +3V**

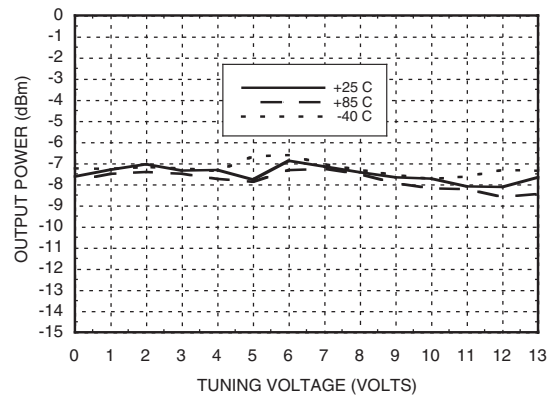

Absolute Maximum Ratings

Vcc1, Vcc2	+3.5 Vdc
Vtune	0 to +15V
Junction Temperature	135 °C
Continuous Pdiss (T=85 °C) (derate 27 mW/C above 85 °C)	1.3 W
Thermal Resistance (junction to ground paddle)	37.5 °C/W
Storage Temperature	-65 to +150 °C
Operating Temperature	-40 to +85 °C

Typical Supply Current vs. Vcc

Vcc (V)	Icc (mA)
2.75	230
3.0	275
3.25	320

Note: VCO will operate over full voltage range shown above.



**ELECTROSTATIC SENSITIVE DEVICE
OBSERVE HANDLING PRECAUTIONS**

Outline Drawing

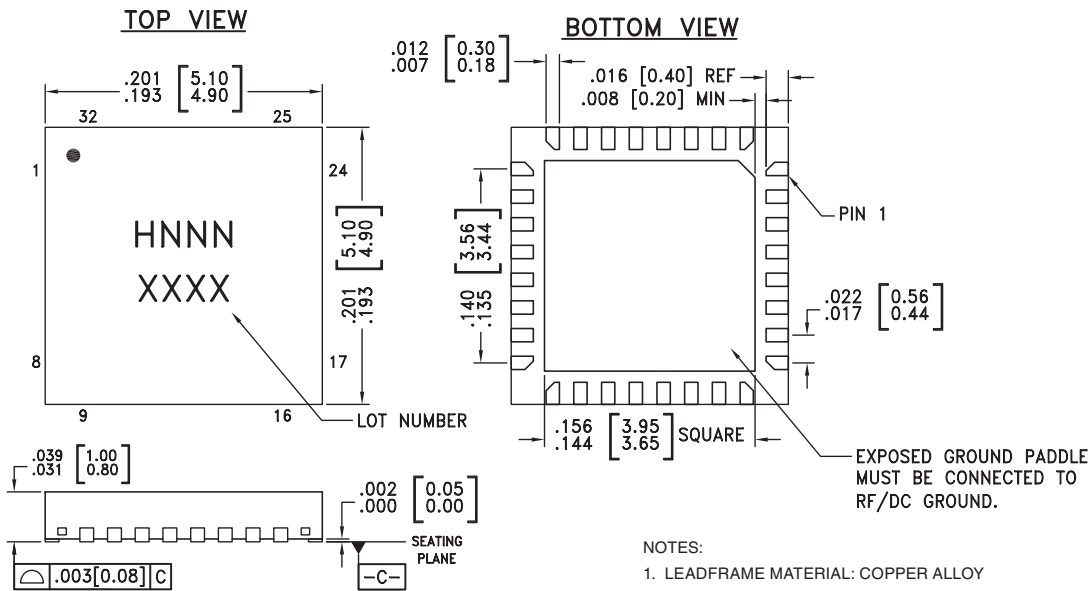

NOTES:

- LEADFRAME MATERIAL: COPPER ALLOY
- DIMENSIONS ARE IN INCHES [MILLIMETERS]
- LEAD SPACING TOLERANCE IS NON-CUMULATIVE.
- PAD BURR LENGTH SHALL BE 0.15mm MAXIMUM.
PAD BURR HEIGHT SHALL BE 0.05mm MAXIMUM.
- PACKAGE WARP SHALL NOT EXCEED 0.05mm.
- ALL GROUND LEADS AND GROUND PADDLE MUST BE SOLDERED TO PCB RF GROUND.
- REFER TO HITTITE APPLICATION NOTE FOR SUGGESTED LAND PATTERN.

Package Information

Part Number	Package Body Material	Lead Finish	MSL Rating	Package Marking ^[3]
HMC514LP5	Low Stress Injection Molded Plastic	Sn/Pb Solder	MSL1 ^[1]	H514 XXXX
HMC514LP5E	RoHS-compliant Low Stress Injection Molded Plastic	100% matte Sn	MSL1 ^[2]	H514 XXXX

[1] Max peak reflow temperature of 235 °C

[2] Max peak reflow temperature of 260 °C



[3] 4-Digit lot number XXXX

For price, delivery, and to place orders, please contact Hittite Microwave Corporation:
20 Alpha Road, Chelmsford, MA 01824 Phone: 978-250-3343 Fax: 978-250-3373
Order On-line at www.hittite.com

MMIC VCO w/ HALF FREQUENCY OUTPUT & DIVIDE-BY-4, 11.17 - 12.02 GHz

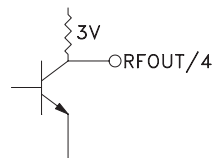
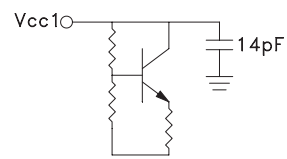
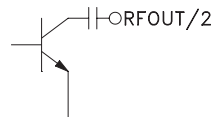
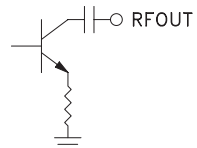
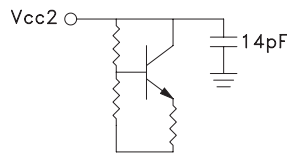
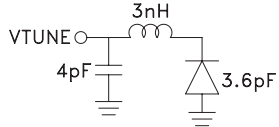

Pin Descriptions

Pin Number	Function	Description	Interface Schematic
1-3, 5, 7-11, 13-18, 20, 22-28, 30-32	N/C	No Connection. These pins may be connected to RF/DC ground. Performance will not be affected.	
4	RFOUT/4	Divide-by-4 Output.	
6	VCC1	Supply Voltage for prescaler. If prescaler is not required, this pin may be left open to conserve 40 mA of current.	
12	RFOUT/2	Half frequency output (AC coupled).	
19	RF OUT	RF output (AC coupled).	
21	VCC2	Supply Voltage, +3V	
29	VTUNE	Control Voltage Input. Modulation port bandwidth dependent on drive source impedance.	
	GND	Package bottom has an exposed metal paddle that must be connected to RF/DC ground.	

Evaluation PCB

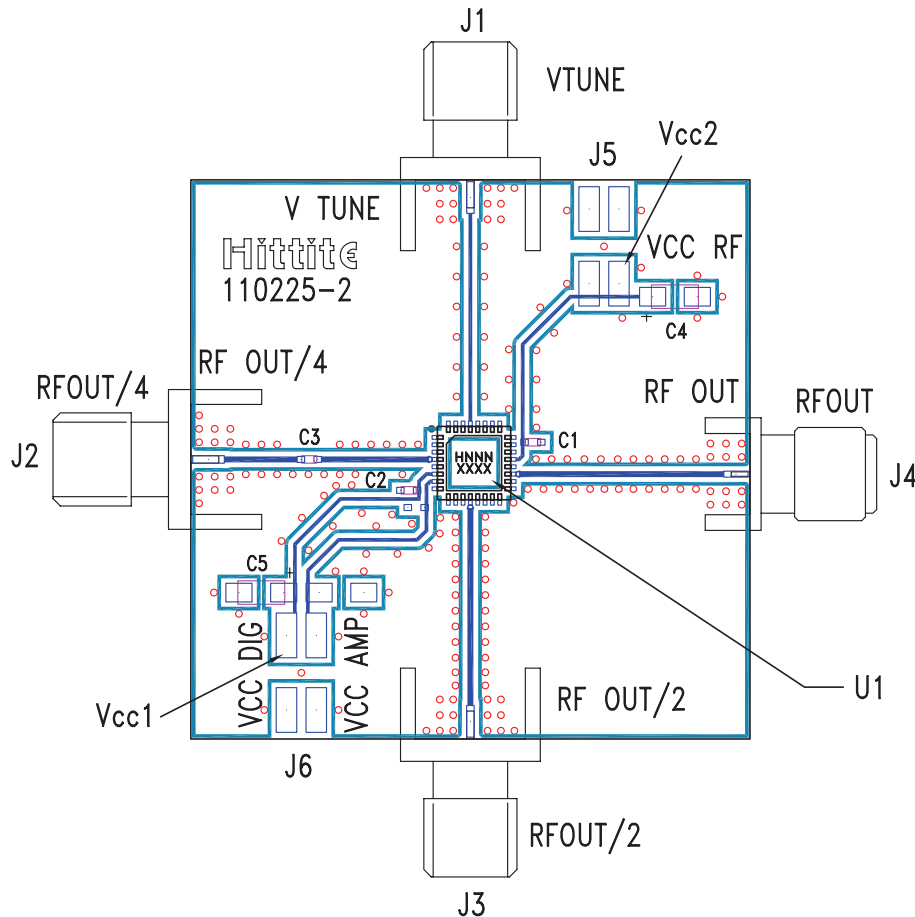

List of Materials for Evaluation PCB 110227 [1]

Item	Description
J1 - J4	PCB Mount SMA RF Connector
J5 - J6	2 mm DC Header
C1 - C2	100 pF Capacitor, 0402 Pkg.
C3	1,000 pF Capacitor, 0402 Pkg.
C4 - C5	2.2 μF Tantalum Capacitor
U1	HMC514LP5 / HMC514LP5E VCO
PCB [2]	110225 Eval Board

[1] Reference this number when ordering complete evaluation PCB

[2] Circuit Board Material: Rogers 4350

The circuit board used in the final application should use RF circuit design techniques. Signal lines should have 50 ohm impedance while the package ground leads and backside ground paddle should be connected directly to the ground plane similar to that shown. A sufficient number of via holes should be used to connect the top and bottom ground planes. The evaluation circuit board shown is available from Hittite upon request.



**MMIC VCO w/ HALF FREQUENCY OUTPUT
& DIVIDE-BY-4, 11.17 - 12.02 GHz**

Typical Application Circuit

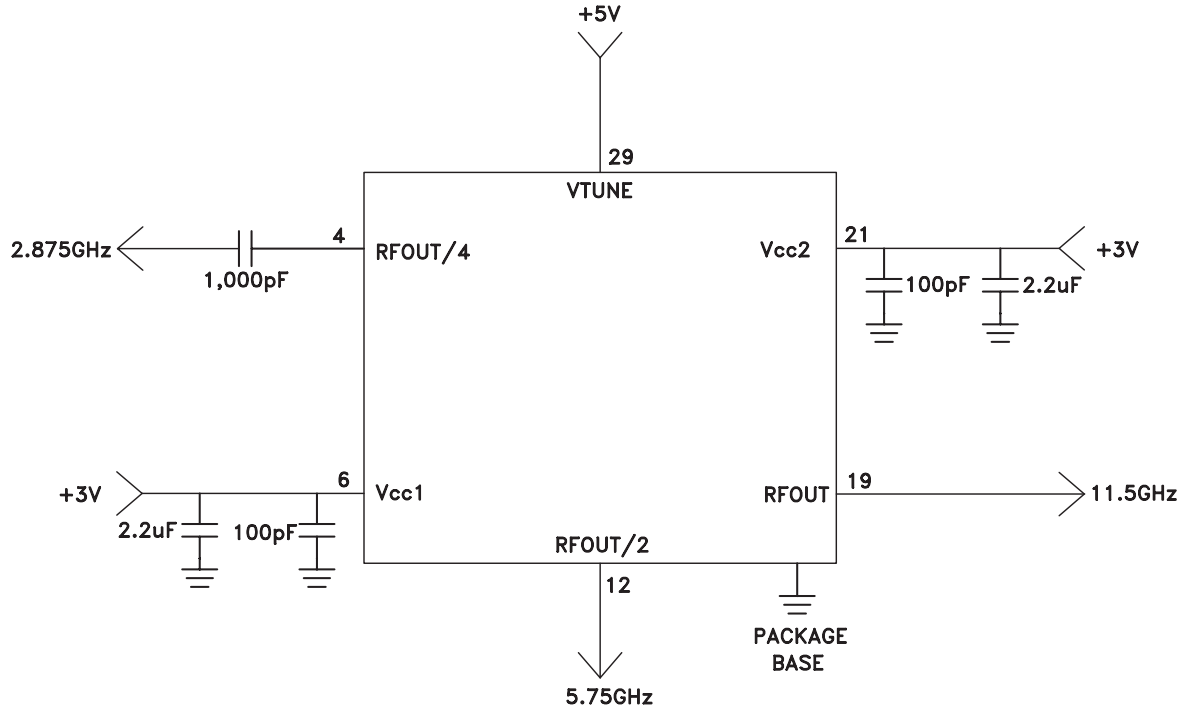



Notes: