



Typical Applications

Low noise MMIC VCO w/Buffer Amplifier for:

- VSAT Radio
- Point to Point/Multipoint Radio
- Test Equipment & Industrial Controls
- Military End-Use

Features

- Pout: +14 dBm
- Phase Noise: -103 dBc/Hz @100 KHz
- No External Resonator Needed
- Single Supply: +3V @ 77 mA
- QFN Leadless SMT Package, 16 mm²

Functional Diagram

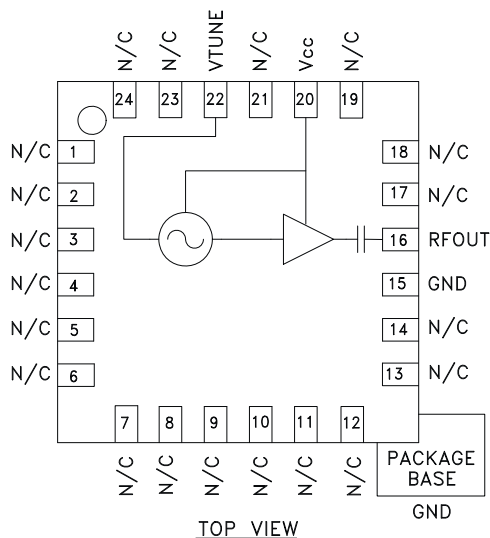

General Description

The HMC506LP4 & HMC506LP4E are GaAs InGaP Heterojunction Bipolar Transistor (HBT) MMIC VCOs with integrated resonators, negative resistance devices, varactor diodes, and buffer amplifiers. Covering 7.8 to 8.7 GHz, the VCO's phase noise performance is excellent over temperature, shock and vibration due to the oscillator's monolithic structure. Power output is +14 dBm typical from a single supply of +3.0V @ 77 mA. The voltage controlled oscillator is packaged in a leadless QFN 4 x 4 mm surface mount package.

Electrical Specifications, $T_A = +25^\circ C$, $V_{cc} = +3V$

Parameter	Min.	Typ.	Max.	Units
Frequency Range		7.8 - 8.7		GHz
Power Output	11.0	14.0		dBm
SSB Phase Noise @ 100 kHz Offset, $V_{tune} = +5V$ @ RF Output		-103		dBc/Hz
Tune Voltage (V_{tune})	1		11	V
Supply Current (I_{cc}) ($V_{cc} = +3.0V$)		77		mA
Tune Port Leakage Current			10	μA
Output Return Loss		7		dB
Harmonics				
2nd		-16		dBc
3rd		-28		dBc
Pulling (into a 2.0:1 VSWR)		28		MHz pp
Pushing @ $V_{tune} = +5V$		78		MHz/V
Frequency Drift Rate		0.85		MHz/ $^\circ C$

For price, delivery, and to place orders, please contact Hittite Microwave Corporation:
20 Alpha Road, Chelmsford, MA 01824 Phone: 978-250-3343 Fax: 978-250-3373
Order On-line at www.hittite.com

Frequency vs. Tuning Voltage, $T = 25^{\circ}\text{C}$

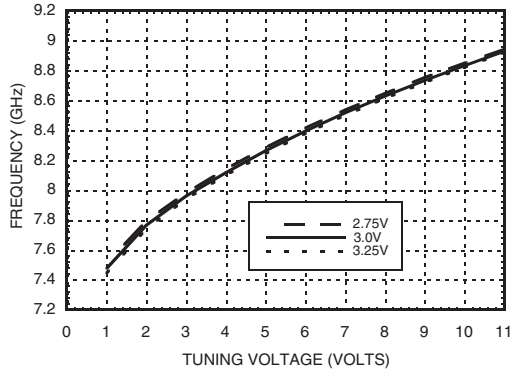

Frequency vs. Tuning Voltage, $V_{cc} = +3V$

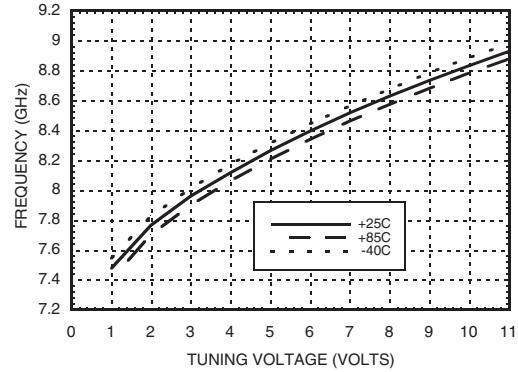

Sensitivity vs. Tuning Voltage, $V_{cc} = +3V$

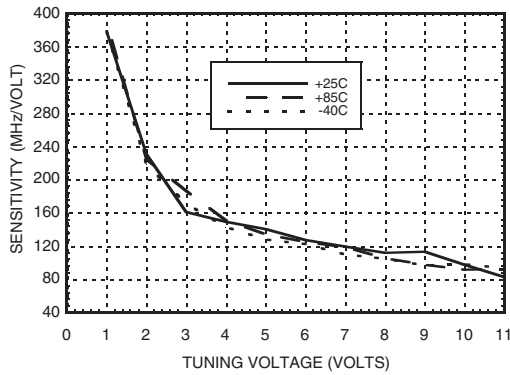

Output Power vs. Tuning Voltage, $V_{cc} = +3V$

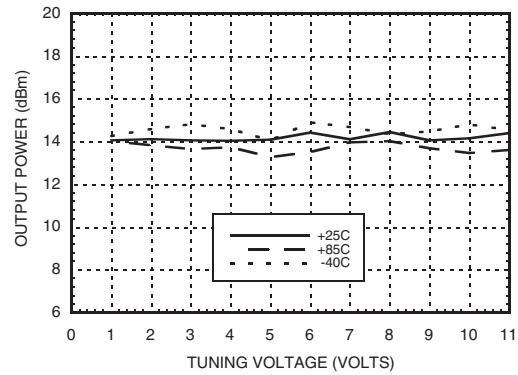

Phase Noise vs. Tuning Voltage

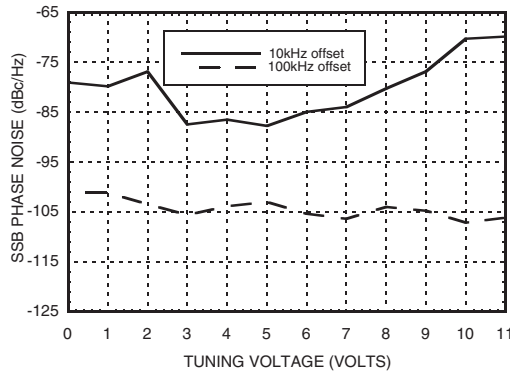

Typical SSB Phase Noise @ $V_{tune} = +5V$

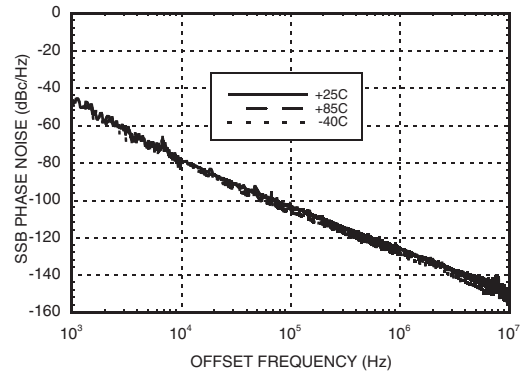

For price, delivery, and to place orders, please contact Hittite Microwave Corporation:
20 Alpha Road, Chelmsford, MA 01824 Phone: 978-250-3343 Fax: 978-250-3373
Order On-line at www.hittite.com

Absolute Maximum Ratings

Vcc	+3.5 Vdc
Vtune	0 to +11V
Channel Temperature	135 °C
Continuous Pdiss (T = 85°C) (derate 6.07 mW/°C above 85°C)	303 mW
Thermal Resistance (junction to ground paddle)	165 °C/W
Storage Temperature	-65 to +150 °C
Operating Temperature	-40 to +85 °C

Typical Supply Current vs. Vcc

Vcc (V)	Icc (mA)
2.75	66
3.0	77
3.25	88

Note: VCO will operate over full voltage range shown above.



**ELECTROSTATIC SENSITIVE DEVICE
OBSERVE HANDLING PRECAUTIONS**

Outline Drawing

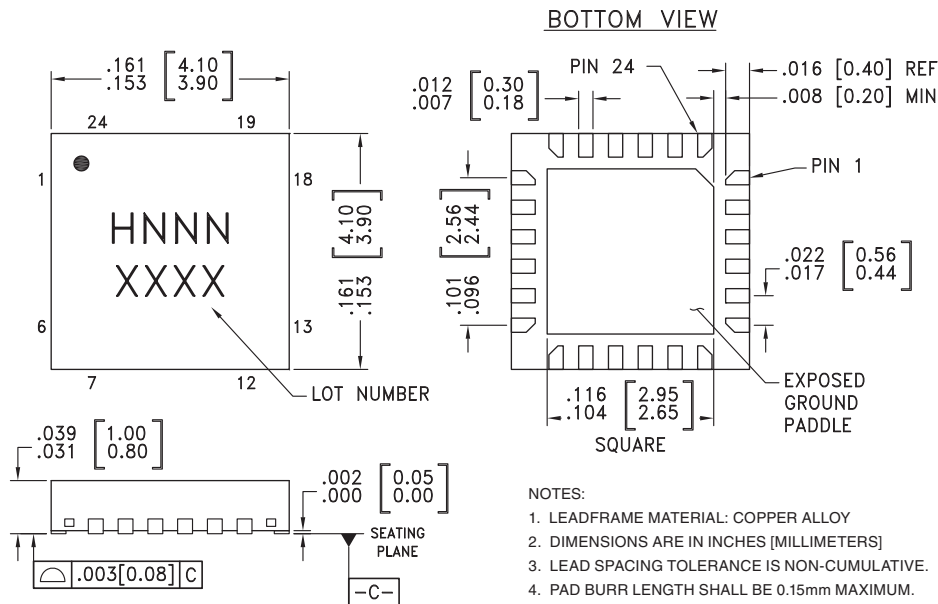

NOTES:

1. LEADFRAME MATERIAL: COPPER ALLOY
2. DIMENSIONS ARE IN INCHES [MILLIMETERS]
3. LEAD SPACING TOLERANCE IS NON-CUMULATIVE.
4. PAD BURR LENGTH SHALL BE 0.15mm MAXIMUM. PAD BURR HEIGHT SHALL BE 0.05mm MAXIMUM.
5. PACKAGE WARP SHALL NOT EXCEED 0.05mm.
6. ALL GROUND LEADS AND GROUND PADDLE MUST BE SOLDERED TO PCB RF GROUND.
7. REFER TO HITTITE APPLICATION NOT FOR SUGGESTED LAND PATTERN.

Package Information

Part Number	Package Body Material	Lead Finish	MSL Rating	Package Marking ^[3]
HMC506LP4	Low Stress Injection Molded Plastic	Sn/Pb Solder	MSL1 ^[1]	H506 XXXX
HMC506LP4E	RoHS-compliant Low Stress Injection Molded Plastic	100% matte Sn	MSL1 ^[2]	H506 XXXX

[1] Max peak reflow temperature of 235 °C



[2] Max peak reflow temperature of 260 °C

[3] 4-Digit lot number XXXX

For price, delivery, and to place orders, please contact Hittite Microwave Corporation:
20 Alpha Road, Chelmsford, MA 01824 Phone: 978-250-3343 Fax: 978-250-3373
Order On-line at www.hittite.com

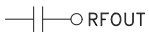
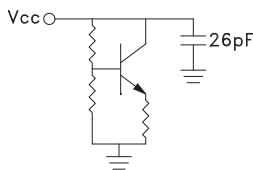
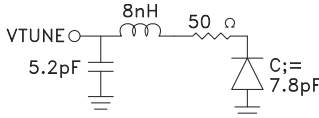

Pin Descriptions

Pin Number	Function	Description	Interface Schematic
1- 14, 17 - 19, 21, 23, 24	N/C	No Connection	
15	GND	This pin must be connected to RF & DC ground.	
16	RFOUT	RF output (AC coupled)	
20	Vcc	Supply Voltage Vcc= 3V	
22	VTUNE	Control Voltage Input. Modulation port bandwidth dependent on drive source impedance.	
	GND	Package bottom has an exposed metal paddle that must be RF & DC grounded.	

Evaluation PCB

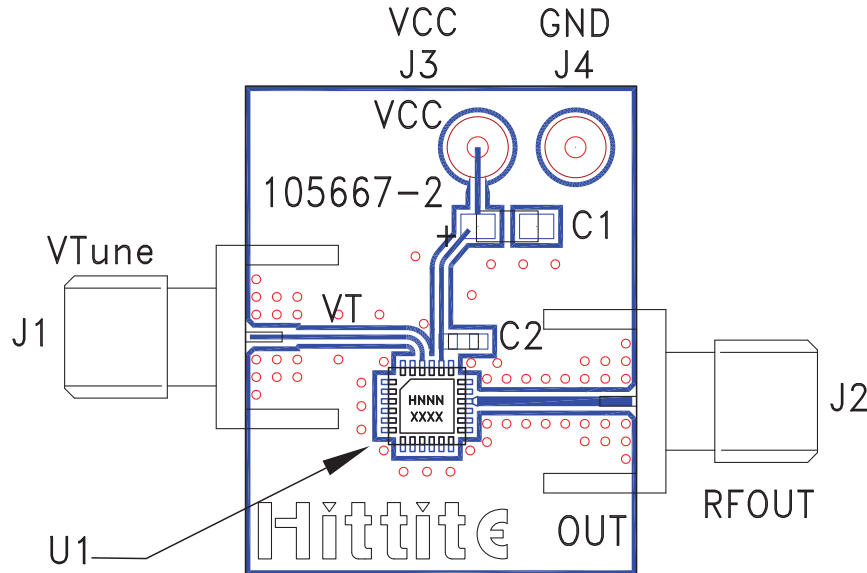

List of Materials for Evaluation PCB 105706 [1]

Item	Description
J1 - J2	PCB Mount SMA RF Connector
J3 - J4	DC Pin
C1	4.7 μ F Tantalum Capacitor
C2	10,000 pF Capacitor, 0603 Pkg.
U1	HMC506LP4 / HMC506LP4E VCO
PCB [2]	105667 Eval Board

[1] Reference this number when ordering complete evaluation PCB

[2] Circuit Board Material: Rogers 4350

The circuit board used in the final application should use RF circuit design techniques. Signal lines should have 50 ohm impedance while the package ground leads and exposed paddle should be connected directly to the ground plane similar to that shown. A sufficient number of via holes should be used to connect the top and bottom ground planes. The evaluation circuit board shown is available from Hittite upon request.

For price, delivery, and to place orders, please contact Hittite Microwave Corporation:
20 Alpha Road, Chelmsford, MA 01824 Phone: 978-250-3343 Fax: 978-250-3373
Order On-line at www.hittite.com



HMC506LP4 / 506LP4E

**MMIC VCO w/ BUFFER
AMPLIFIER, 7.8 - 8.7 GHz**

Notes: