

SMD External Drive Piezo Transducer (AC)

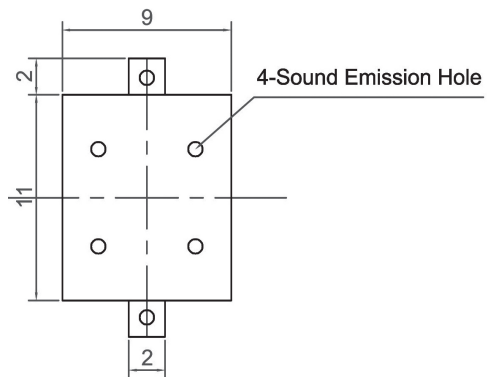

CSPT1102

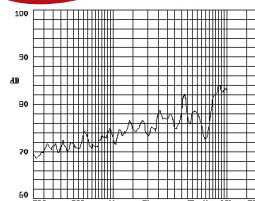

Canopus Part no.	Min sound Output (dBA)	Rated Voltage (V)	Max Input Voltage (V)	Resonant Frequency (Hz)	Capacitance (pF)	Operating Temperature (°C)	Housing	Weight (g)
CSPT1102E41L	75 AT 10cm	5 Vp-p	25 Vp-p	4100	12000 ± 30% at 120Hz	-20 ~ +70	LCP	0.252

CANOPUS

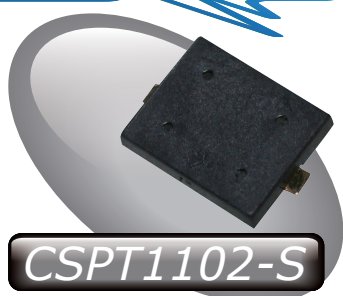

CSPT1102-S

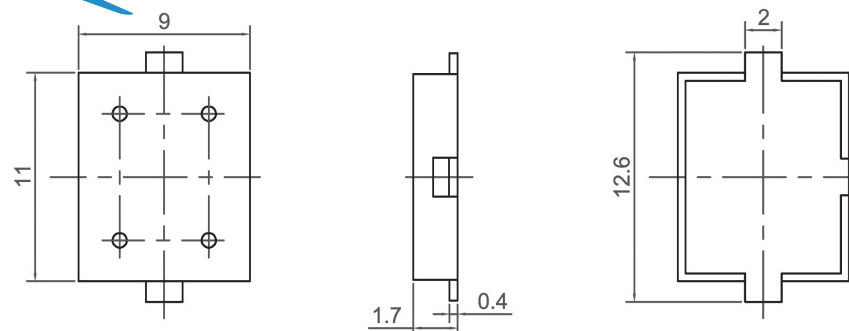
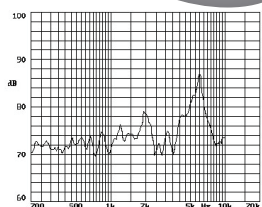

Canopus Part no.	Min sound Output (dBA)	Rated Voltage (V)	Max Input Voltage (V)	Resonant Frequency (Hz)	Capacitance (pF)	Operating Temperature (°C)	Housing	Weight (g)
CSPT1102E41LS	70 AT 10cm	5 Vp-p	25 Vp-p	4100	10000 ± 30% at 120Hz	-20 ~ +70	PPS	1

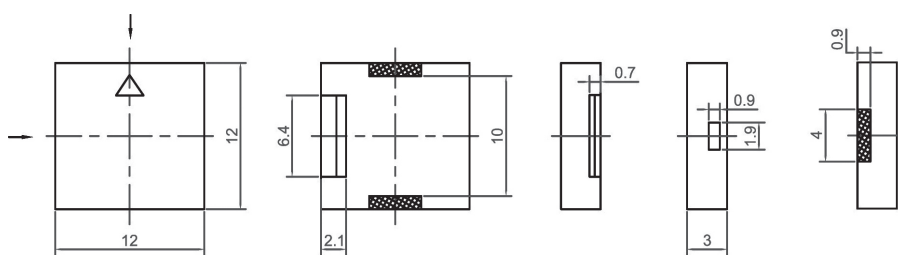

CSPT1203-S

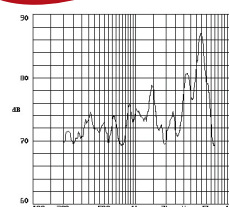

Canopus Part no.	Min sound Output (dBA)	Rated Voltage (V)	Max Input Voltage (V)	Resonant Frequency (Hz)	Capacitance (pF)	Operating Temperature (°C)	Housing	Weight (g)
CSPT1203C40LS	70 AT 10cm	3 Vp-p	25 Vp-p	4000	15000 ± 30% at 120Hz	-20 ~ +70	LCP	1

Your Efficient Supplier
www.canopus.com.hk

TEL.: (852) 2806 2812 Fax: (852) 2652 2216