

LH530800A

CMOS 1M (128K × 8) MROM

FEATURES

- 131,072 words × 8 bit organization
- Access time: 150 ns (MAX.)
- Power consumption:
 - Operating: 192.5 mW (MAX.)
 - Standby: 550 μW (MAX.)
- Static operation
- TTL compatible I/O
- Three-state outputs
- Single +5 V power supply
- Packages:
 - 32-pin, 600-mil DIP
 - 32-pin, 525-mil SOP
 - 32-pin, 450-mil QFJ (PLCC)
- JEDEC standard EPROM pinout (DIP)

DESCRIPTION

The LH530800A is a mask-programmable ROM organized as 131,072 × 8 bits (1,048,576 bits). It is fabricated using silicon-gate CMOS process technology.

PIN CONNECTIONS

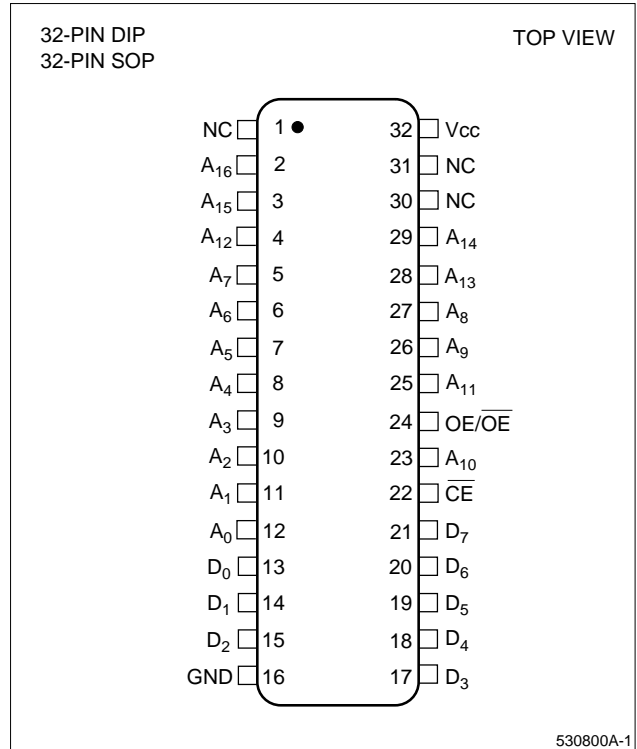

Figure 1. Pin Connections for DIP and SOP Packages

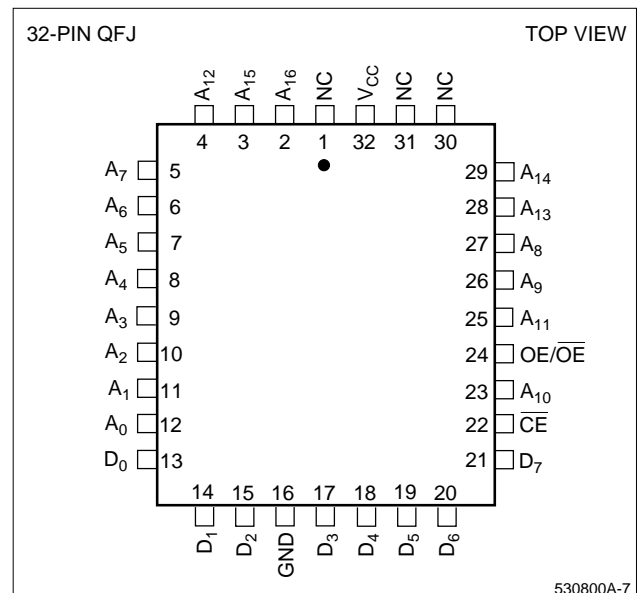
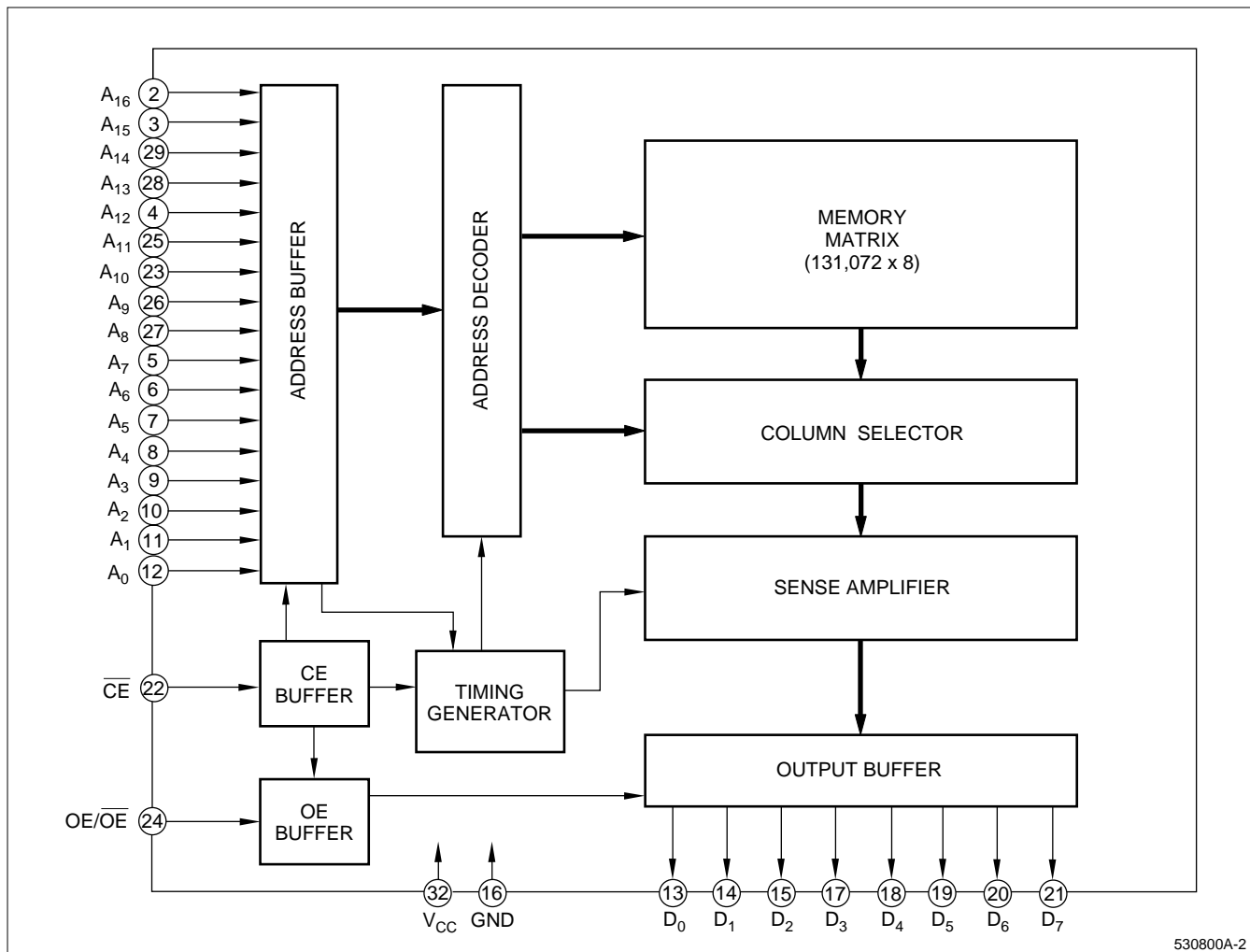

Figure 2. Pin Connections for QFJ (PLCC) Package



530800A-2

Figure 3. LH530800A Block Diagram

PIN DESCRIPTION

SIGNAL	PIN NAME	NOTE
A ₀ - A ₁₆	Address input	
D ₀ - D ₇	Data Output	
CE	Chip enable input	1
OE/OE	Output enable input	1

SIGNAL	PIN NAME	NOTE
V _{CC}	Power supply (+5 V)	
GND	Ground	
NC	No connection	

NOTE:

- Active level of OE/OE is mask-programmable.

TRUTH TABLE

CE	OE/OE	MODE	D ₀ - D ₇	SUPPLY CURRENT	NOTE
H	X	Non selected	High-Z	Standby (I _{SB})	1
L	L/H	Non selected	High-Z	Operating (I _{CC})	
L	H/L	Selected	D _{OUT}	Operating (I _{CC})	

NOTE:

- X = H or L.

ABSOLUTE MAXIMUM RATINGS

PARAMETER	SYMBOL	RATING	UNIT
Supply voltage	V_{CC}	-0.3 to +7.0	V
Input voltage	V_{IN}	-0.3 to $V_{CC} + 0.3$	V
Output voltage	V_{OUT}	-0.3 to $V_{CC} + 0.3$	V
Operating temperature	T_{opr}	0 to +70	°C
Storage temperature	T_{stg}	-65 to +150	°C

RECOMMENDED OPERATING CONDITIONS ($T_A = 0$ to +70°C)

PARAMETER	SYMBOL	MIN.	TYP.	MAX.	UNIT
Supply voltage	V_{CC}	4.5	5.0	5.5	V

DC CHARACTERISTICS ($V_{CC} = 5\text{ V} \pm 10\%$, $T_A = 0$ to +70°C)

PARAMETER	SYMBOL	CONDITIONS	MIN.	TYP.	MAX.	UNIT	NOTE
Input 'Low' voltage	V_{IL}		-0.3		0.8	V	
Input 'High' voltage	V_{IH}		2.2		$V_{CC} + 0.3$	V	
Output 'Low' voltage	V_{OL}	$I_{OL} = 2.0\text{ mA}$			0.4	V	
Output 'High' voltage	V_{OH}	$I_{OH} = -400\text{ }\mu\text{A}$	2.4			V	
Input leakage current	$ I_{LI} $	$V_{IN} = 0\text{ V to }V_{CC}$			10	μA	
Output leakage current	$ I_{LO} $	$V_{OUT} = 0\text{ V to }V_{CC}$			10	μA	1
Operating current	I_{CC1}	$t_{RC} = 150\text{ ns}$			35	mA	2
	I_{CC2}	$t_{RC} = 1\text{ }\mu\text{s}$			25		
	I_{CC3}	$t_{RC} = 150\text{ ns}$			30	mA	3
	I_{CC4}	$t_{RC} = 1\text{ }\mu\text{s}$			20		
Standby current	I_{SB1}	$\overline{CE} = V_{IH}$			2	mA	
	I_{SB2}	$\overline{CE} = V_{CC} - 0.2\text{ V}$			100		μA
Input capacitance	C_{IN}	$f = 1\text{ MHz}$			10	pF	
Output capacitance	C_{OUT}	$T_A = 25^\circ\text{C}$			10		

NOTES:

- $\overline{CE}/\overline{OE} = V_{IH}$ or $\overline{OE} = V_{IL}$
- $V_{IN} = V_{IH}$ or V_{IL} , $\overline{CE} = V_{IL}$, outputs open
- $V_{IN} = (V_{CC} - 0.2\text{ V})$ or 0.2 V , $\overline{CE} = 0.2\text{ V}$, outputs open

AC CHARACTERISTICS ($V_{CC} = 5\text{ V} \pm 10\%$, $T_A = 0$ to +70°C)

PARAMETER	SYMBOL	MIN.	TYP.	MAX.	UNIT	NOTE
Read cycle time	t_{RC}	150			ns	
Address access time	t_{AA}			150	ns	
Chip enable time	t_{ACE}			150	ns	
Output enable time	t_{OE}			70	ns	
Output hold time	t_{OH}	5			ns	
CE to output in High-Z	t_{CHZ}			70	ns	1
OE to output in High-Z	t_{OHZ}			70	ns	

NOTE:

- This is the time required for the output to become high-impedance.

AC TEST CONDITIONS

PARAMETER	RATING
Input voltage amplitude	0.6 V to 2.4 V
Input rise/fall time	10 ns
Input reference level	1.5 V
Output reference level	0.8 V and 2.2 V
Output load condition	1TTL +100 pF

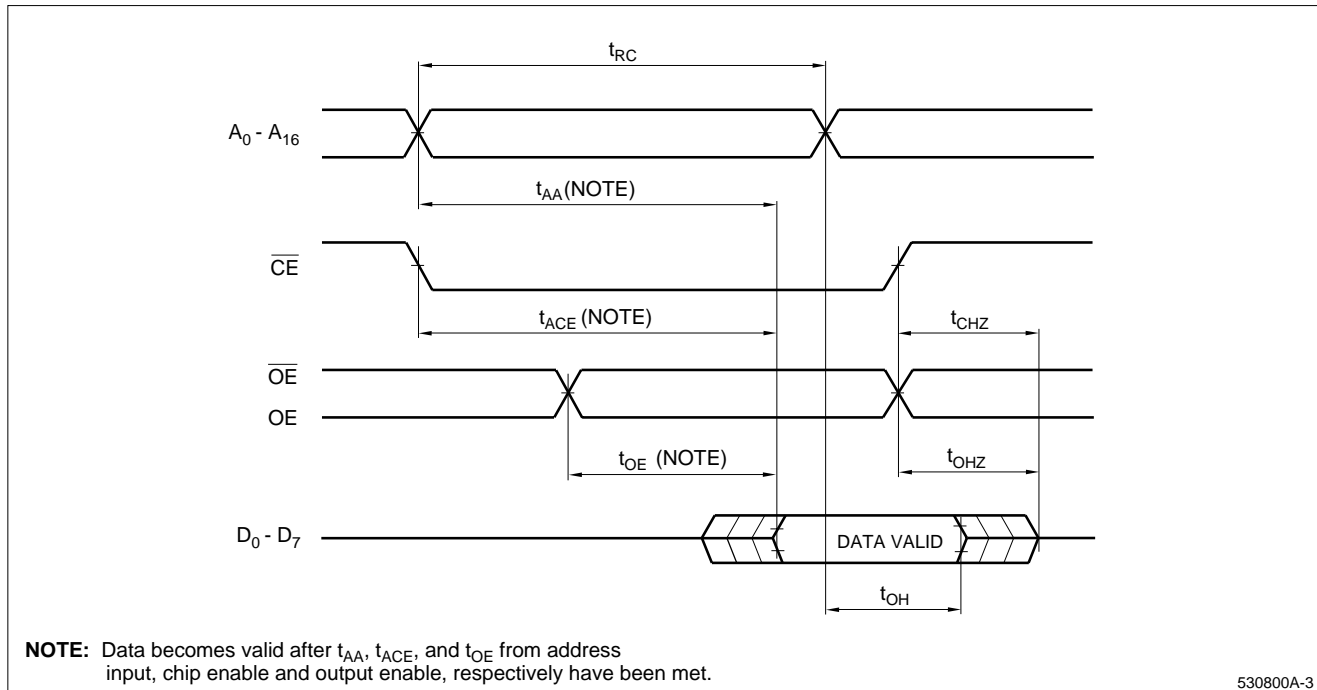
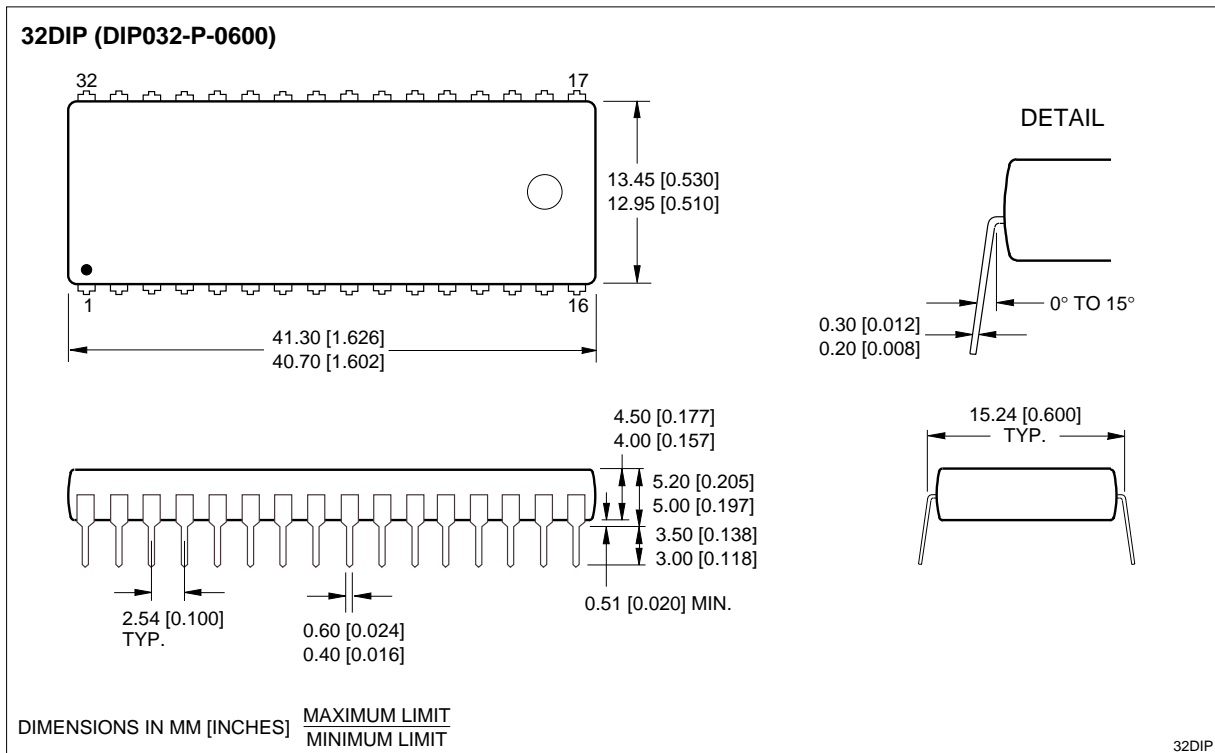
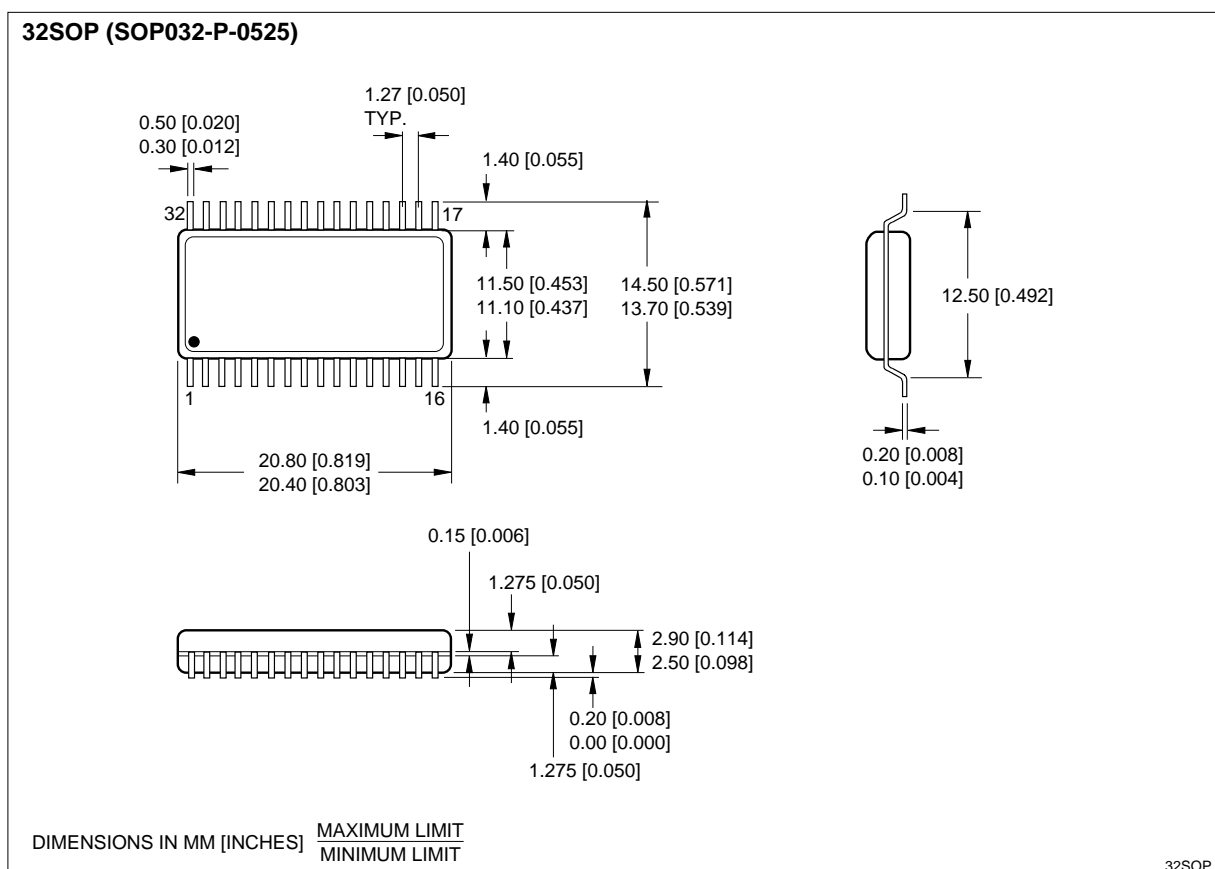

Figure 4. Timing Diagram

PACKAGE DIAGRAMS



32-pin, 600-mil DIP



32-pin, 525-mil SOP

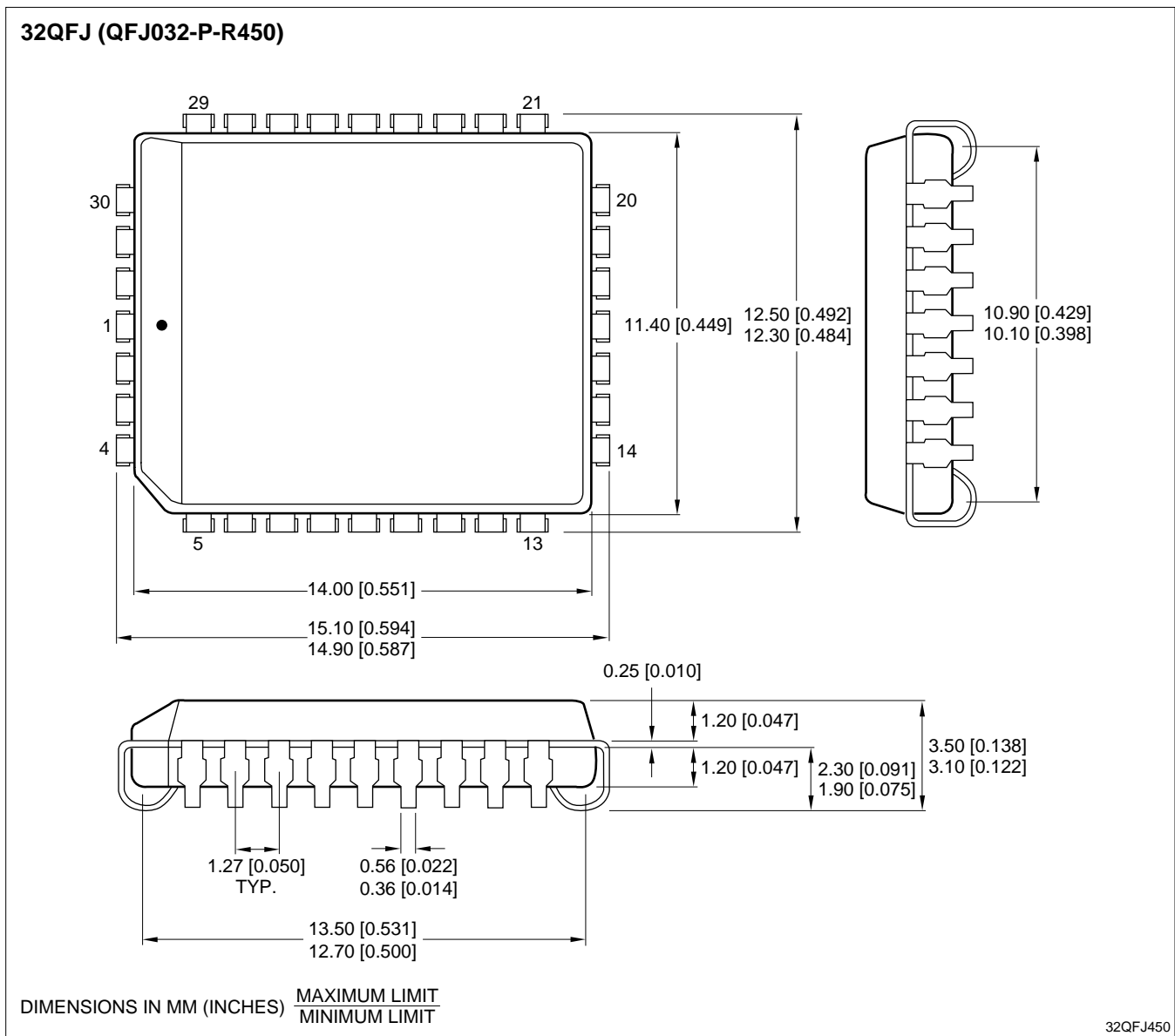

32-pin, 450-mil QFJ (PLCC)

ORDERING INFORMATION

