

No. STSE-CC6130A

<Cat.No.061218>

**SPECIFICATIONS FOR NICHIA CHIP TYPE UV LED**

**MODEL : NCSU033A(T)**

**NICHIA CORPORATION**

## 1.SPECIFICATIONS

### (1) Absolute Maximum Ratings (Ts=25°C)

Item	Symbol	Absolute Maximum Rating	Unit
Forward Current	IF	700	mA
Pulse Forward Current	IFP	1000	mA
Allowable Reverse Current	IR	85	mA
Power Dissipation	PD	3.3	W
Operating Temperature	Topr	-10 ~ + 85	°C
Storage Temperature	Tstg	-40 ~ +100	°C
Dice Temperature	Tj	130	°C

IFP Conditions : Pulse Width  $\leq$  10msec. and Duty  $\leq$  1/10

### (2) Initial Electrical/Optical Characteristics (Ts=25°C)

Item	Symbol	Condition	Min.	Typ.	Max.	Unit	
Forward Voltage	Rank H	VF	IF=500[mA]	4.0	-	4.4	V
	Rank M	VF	IF=500[mA]	3.6	-	4.0	V
	Rank L	VF	IF=500[mA]	3.2	-	3.6	V
Peak Wavelength	Rank Ua	$\lambda_P$	IF=500[mA]	360	(365)	370	nm
Spectrum Half Width		$\Delta\lambda$	IF=500[mA]	-	(9)	-	nm
Optical Power Output	Rank P7	Po	IF=500[mA]	270	-	310	mW
	Rank P6	Po	IF=500[mA]	230	-	270	mW
	Rank P5	Po	IF=500[mA]	190	-	230	mW

\* Ts : The solder temperature of products (Please refer to the drawing, 061130658591.)

\* Forward Voltage Measurement allowance is  $\pm$  3%.

\* Peak Wavelength Measurement allowance is  $\pm$ 3nm.

\* Optical Power Output Measurement allowance is  $\pm$ 10%.

## 2.INITIAL OPTICAL/ELECTRICAL CHARACTERISTICS

Please refer to figure's page.

## 3.OUTLINE DIMENSIONS AND MATERIALS

Please refer to figure's page.

Material as follows ;     Package                             :   Ceramics  
                                  Glass   :   Hard Glass  
                                  Electrodes   :   Au Plating

#### 4.PACKAGING

- The LEDs are packed in cardboard boxes after packaging in moisture proof foil bag.  
Please refer to figure's page.  
The label on the minimum packing unit shows ; Part Number, Lot Number, Ranking, Quantity  
(Taped Type)
- The LEDs are packed in cardboard boxes after taping.  
Please refer to figure's page.  
The label on the minimum packing unit shows ; Part Number, Lot Number, Ranking, Quantity
- In order to protect the LEDs from mechanical shock, we pack them in cardboard boxes for transportation.
- The LEDs may be damaged if the boxes are dropped or receive a strong impact against them,  
so precautions must be taken to prevent any damage.
- The boxes are not water resistant and therefore must be kept away from water and moisture.
- When the LEDs are transported, we recommend that you use the same packing method as Nichia.

#### 5.LOT NUMBER

The first six digits number shows **lot number**.

The lot number is composed of the following characters;

○□×××× - △■●

○ - Year ( 6 for 2006, 7 for 2007 )

□ - Month ( 1 for Jan., 9 for Sep., A for Oct., B for Nov. )

×××× - Nichia's Product Number

△ - Ranking by Wavelength

■ - Ranking by Optical Power Output

● - Ranking by Forward Voltage

## 6.RELIABILITY

### (1) TEST ITEMS AND RESULTS

Test Item	Standard Test Method	Test Conditions	Note	Number of Damaged
Resistance to Soldering Heat (Reflow Soldering)		Tsld=260°C, 10sec.	2 times	0/10
Temperature Cycle	JEITA ED-4701 100 105	-40°C ~ 25°C ~ 100°C ~ 25°C 30min. 5min. 30min. 5min.	100 cycles	0/10
High Temperature Storage	JEITA ED-4701 200 201	Ta=100°C	500hrs.	0/10
Low Temperature Storage	JEITA ED-4701 200 202	Ta=-40°C	500hrs.	0/10
Steady State Operating Life Condition 1		Ta=25°C, IF=500mA Tested with Nichia standard circuit board.*	500hrs.	0/10
Steady State Operating Life Condition 2		Ta=25°C, IF=700mA Tested with Nichia standard circuit board.*	500hrs.	0/10
Steady State Operating Life of High Temperature		Ta=85°C, IF=300mA Tested with Nichia standard circuit board.*	500hrs.	0/10
Steady State Operating Life of High Humidity Heat		60°C, RH=90%, IF=450mA Tested with Nichia standard circuit board.*	500hrs.	0/10
Steady State Operating Life of Low Temperature		Ta=-10°C, IF=500mA Tested with Nichia standard circuit board.*	500hrs.	0/10
Vibration	JEITA ED-4701 400 403	100 ~ 2000 ~ 100Hz Sweep 4min. 200m/s <sup>2</sup> 3directions, 4cycles	48min.	0/10
Electrostatic Discharge	JEITA ED-4701 300 304	R=1.5kΩ, C=100pF Test Voltage=2kV	3 times Negative/Positive	0/10

\* Thermal resistance of LED with Nichia standard circuit board :  $R_{ja} \doteq 35^{\circ}\text{C}/\text{W}$

### (2) CRITERIA FOR JUDGING DAMAGE

Item	Symbol	Test Conditions	Criteria for Judgement	
			Min.	Max.
Forward Voltage	V <sub>F</sub>	IF=500mA	-	Initial Level × 1.1
Optical Power Output	P <sub>o</sub>	IF=500mA	Initial Level × 0.7	-

\* The test is done after the board is cooled down enough at the room temperature.

## 7. CAUTIONS

### (1) Cautions

- The devices are UV light LEDs. The LED during operation radiates intense UV light, which precautions must be taken to prevent looking directly at the UV light with unaided eyes. Do not look directly into the UV light or look through the optical system. When there is a possibility to receive the reflection of light, protect by using the UV light protective glasses so that light should not catch one's eye directly.
- The caution label is attached to the moisture proof foil bag and cardboard box.

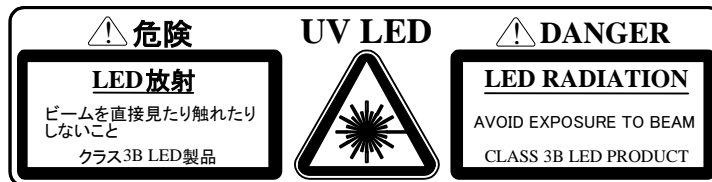

### (2) Storage

- Storage Conditions

Before opening the package :

The LEDs should be kept at 30°C or less and 90%RH or less. The LEDs should be used within a year. When storing the LEDs, moisture proof packaging with absorbent material (silica gel) is recommended.

After opening the package :

If unused LEDs remain, they should be stored in moisture proof packages, such as sealed containers with packages of moisture absorbent material (silica gel). It is also recommended to return the LEDs to the original moisture proof bag and to reseal the moisture proof bag again.

- Nichia LED electrodes are gold plated. The silver surface may be affected by environments which contain corrosive substances. Please avoid conditions which may cause the LED to corrode, tarnish or discolor. This corrosion or discoloration may cause difficulty during soldering operations. It is recommended that the User use the LEDs as soon as possible.
- Please avoid rapid transitions in ambient temperature, especially in high humidity environments where condensation can occur.

### (3) Heat Generation

- Thermal design of the end product is of paramount importance. Please consider the heat generation of the LED when making the system design. The coefficient of temperature increase per input electric power is affected by the thermal resistance of the circuit board and density of LED placement on the board, as well as other components. It is necessary to avoid intense heat generation and operate within the maximum ratings given in this specification.
- Please decide on operating current volume according to LEDs' ambient temperature and conduct heat release treatment.
- The equation ① indicates correlation between T<sub>j</sub> and T<sub>a</sub>, and the equation ② indicates correlation between T<sub>j</sub> and T<sub>s</sub>.

$$T_j = T_a + R_{ja} \cdot W \quad \text{..... ①} \qquad T_j = T_s + R_{js} \cdot W \quad \text{..... ②}$$

\*T<sub>j</sub> = Dice Temperature : °C, T<sub>a</sub> = Ambient Temperature : °C, T<sub>s</sub> = Solder Temperature : °C

R<sub>ja</sub> = Heat resistance from Dice to Ambient temperature : °C /W,

R<sub>js</sub> = Heat resistance from Dice to T<sub>s</sub> measuring point : °C /W,

W = Inputting Power (I<sub>F</sub> × V<sub>F</sub>) : W

- Maximum T<sub>j</sub> shall be under 130°C. Keeping T<sub>j</sub> less or equal to 100°C is recommended.

(4) Soldering Conditions

- The LEDs can be soldered in place using the reflow soldering method. Nichia cannot make a guarantee on the LEDs after they have been assembled using the dip soldering method.
- Recommended soldering conditions

Reflow Soldering		
	Lead Solder	Lead-free Solder
Pre-heat	120 ~ 150°C	180 ~ 200°C
Pre-heat time	120 sec. Max.	120 sec. Max.
Peak temperature	240°C Max.	260°C Max.
Soldering time	10 sec. Max.	10 sec. Max.
Condition	refer to Temperature - profile ①.	refer to Temperature - profile ②. (N <sub>2</sub> reflow is recommended.)

\* Although the recommended soldering conditions are specified in the above table, reflow soldering at the lowest possible temperature is desirable for the LEDs.

\* A rapid-rate process is not recommended for cooling the LEDs down from the peak temperature.

[Temperature-profile (Surface of circuit board)]

<① : Lead Solder>

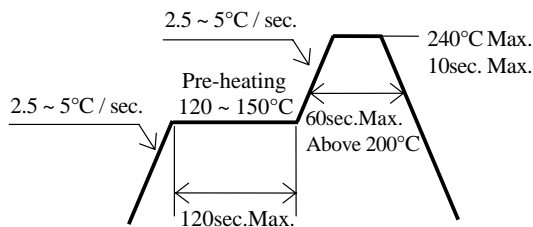

[Recommended soldering pad design]

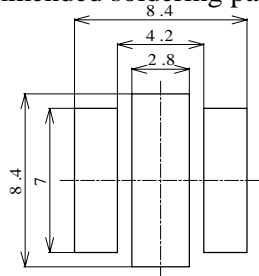

(Unit : mm)

Use the conditions shown to the under figure.

<② : Lead-free Solder>

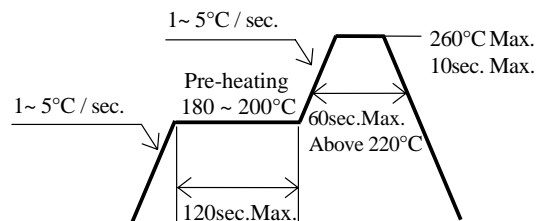

Use the following conditions shown in the figure.

- Occasionally there is a brightness decrease caused by the influence of heat or ambient atmosphere during air reflow. It is recommended that the User use the nitrogen reflow method.
- Repairing should not be done after the LEDs have been soldered. When repairing is unavoidable, a hot plate should be used. It should be confirmed beforehand whether the characteristics of the LEDs will or will not be damaged by repairing.
- Reflow soldering should not be done more than two times.
- When soldering, do not put stress on the LEDs during heating.
- After soldering, do not warp the circuit board.

(5) Cleaning

- Please do not use ultrasonic cleaning, which may reduce the reliability of the product.

#### (6) Static Electricity

- Static electricity or surge voltage damages the LEDs.  
It is recommended that a wrist band or an anti-electrostatic glove be used when handling the LEDs.
- All devices, equipment and machinery must be properly grounded. It is recommended that precautions be taken against surge voltage to the equipment that mounts the LEDs.
- When inspecting the final products in which LEDs were assembled, it is recommended to check whether the assembled LEDs are damaged by static electricity or not. It is easy to find static-damaged LEDs by a light-on test or a VF test at a lower current (below 10mA is recommended). The LEDs should be used the light detector etc. when testing the light-on. Do not stare into the LEDs when testing.
- Damaged LEDs will show some unusual characteristics such as the forward voltage becomes lower, or the LEDs do not light at the low current.

Criteria : ( $V_F > 2.5V$  at  $I_F=5mA$ )

#### (7) Safety Guideline for Human Eyes

- In 1993, the International Electric Committee (IEC) issued a standard concerning laser product safety (IEC 825-1). Since then, this standard has been applied for diffused light sources (LEDs) as well as lasers. In 1998 IEC 60825-1 Edition 1.1 evaluated the magnitude of the light source. In 2001 IEC 60825-1 Amendment 2 converted the laser class into 7 classes for end products. Components are excluded from this system. Products which contain visible LEDs are now classified as class 1. This LED is classified as class 3B. Products containing LEDs can be classified as class 2 in cases where viewing angles are narrow, optical manipulation intensifies the light, and/or the energy emitted is high. For these systems it is recommended to avoid long term exposure. It is also recommended to follow the IEC regulations regarding safety and labeling of products.

#### (8) Others

- NCSU033A complies with RoHS Directive.
- The LEDs are attached glass for air sealing and optical performance. If the glass faces are damaged by mechanical objects, there is possibility of losing its air sealing and optical performance.
- This LED also emits visible light. Please take notice of visible light spectrum, in case you use this LED as light source of sensors etc.
- The LEDs described in this brochure are intended to be used for ordinary electronic equipment (such as office equipment, communications equipment, measurement instruments and household appliances). Consult Nichia's sales staff in advance for information on the applications in which exceptional quality and reliability are required, particularly when the failure or malfunction of the LEDs may directly jeopardize life or health (such as for airplanes, aerospace, submersible repeaters, nuclear reactor control systems, automobiles, traffic control equipment, life support systems and safety devices).
- User shall not reverse engineer by disassembling or analysis of the LEDs without having prior written consent from Nichia. When defective LEDs are found, the User shall inform Nichia directly before disassembling or analysis.
- The formal specifications must be exchanged and signed by both parties before large volume purchase begins.
- The appearance and specifications of the product may be modified for improvement without notice.

■ Forward Voltage vs. Forward Current

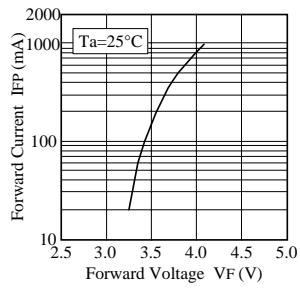

■ Forward Current vs. Relative Power Output

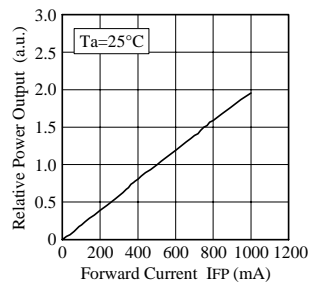

■ Ambient Temperature vs. Allowable Forward Current

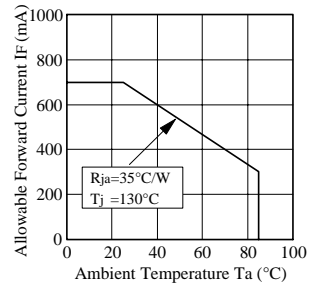

■ Ambient Temperature vs. Forward Voltage

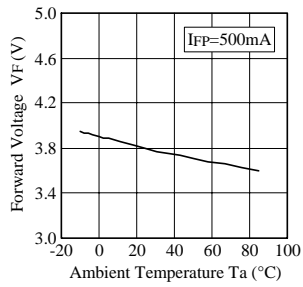

■ Ambient Temperature vs. Relative Power Output

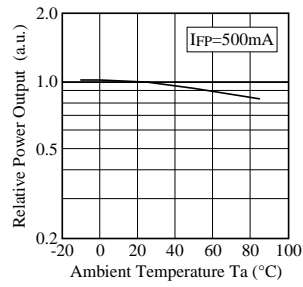

NICHIA CORPORATION	Model	NCSU033A
	Title	CHARACTERISTICS
	No.	061208658971



■ Forward Current vs. Peak Wavelength

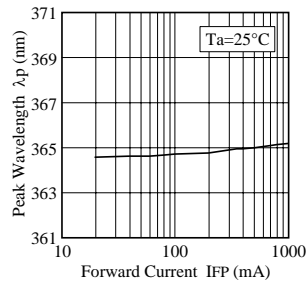

■ Spectrum

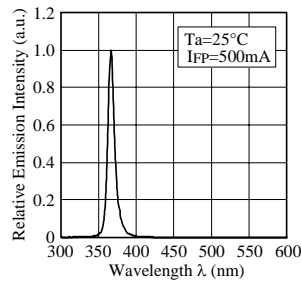

■ Ambient Temperature vs. Peak Wavelength

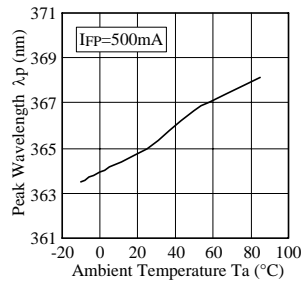

■ Directivity

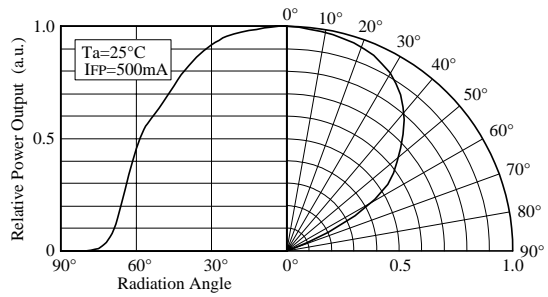

NICHIA CORPORATION	Model	NCSU033A
	Title	CHARACTERISTICS
	No.	061208658981

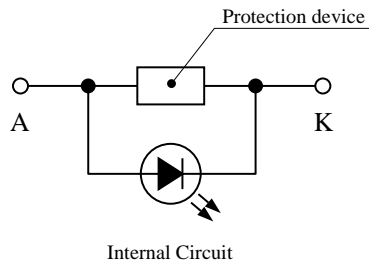
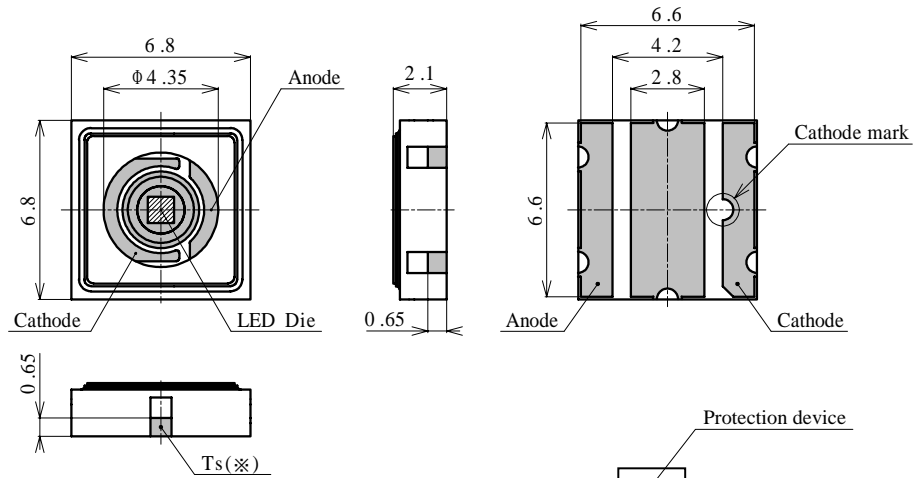

- \* Ts : Measure point of solder
- \*\* NCSU033A has a protection device built in as a protection circuit against static electricity.

ITEM	MATERIALS
PACKAGE	Ceramics
GLASS	Hard Glass
ELECTRODES	Au Plating

NICHIA CORPORATION	Model	NCSU033A	Unit mm
	Title	OUTLINE DIMENSIONS	
	No.	061130658591	Allow ±0.2

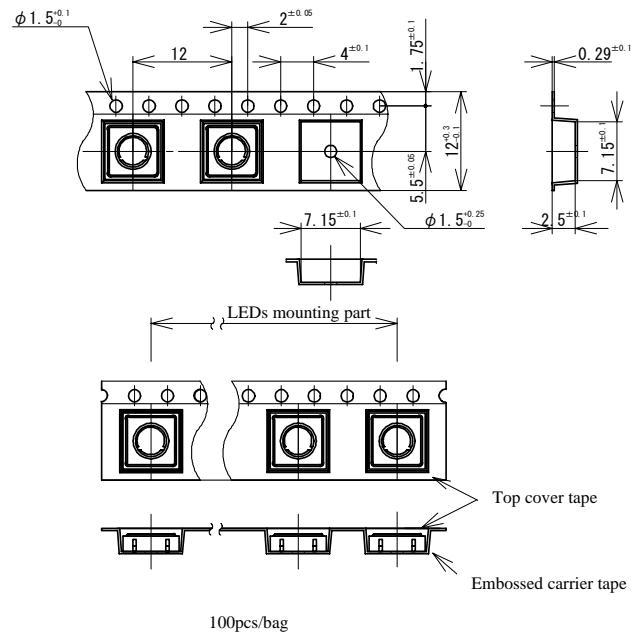

<b>NICHIA CORPORATION</b>	Model	NCxU033x	Unit mm
	Title	PACKING	Scale
	No.	061130536742	Allow

The IC pack and moisture absorbent material are put in the moisture proof foil bag and then heat sealed.

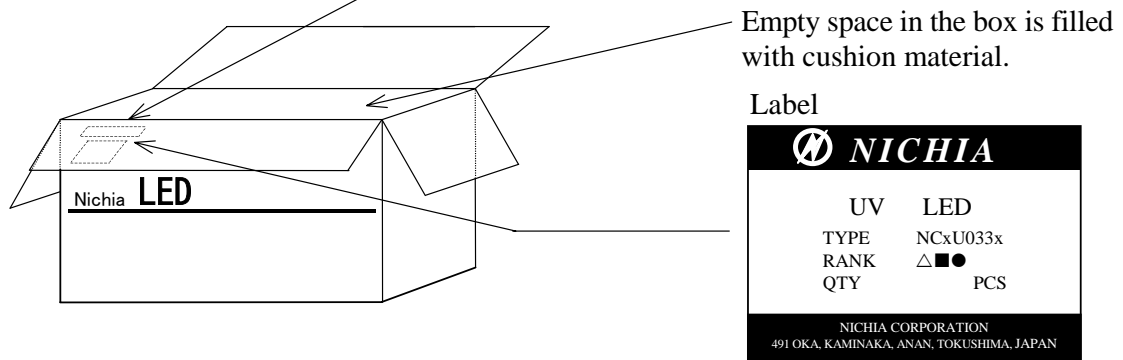
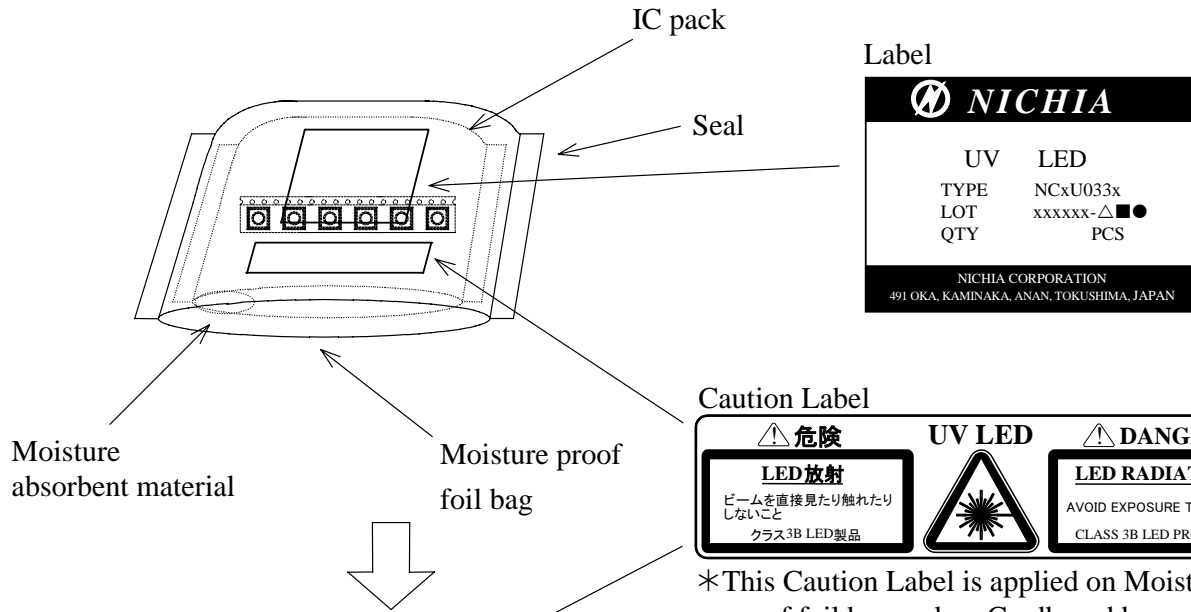

**Packing unit**

	Quantity/bag (pcs)
Moisture proof foil bag	100 MAX.

Cardboard box	Dimensions (mm)	Bag/box	Quantity/box (pcs)
Cardboard box S	250×140×90×4t	5bag MAX.	500 MAX.

NICHIA CORPORATION	Model	NCxU033x
	Title	PACKING
	No.	061130536752

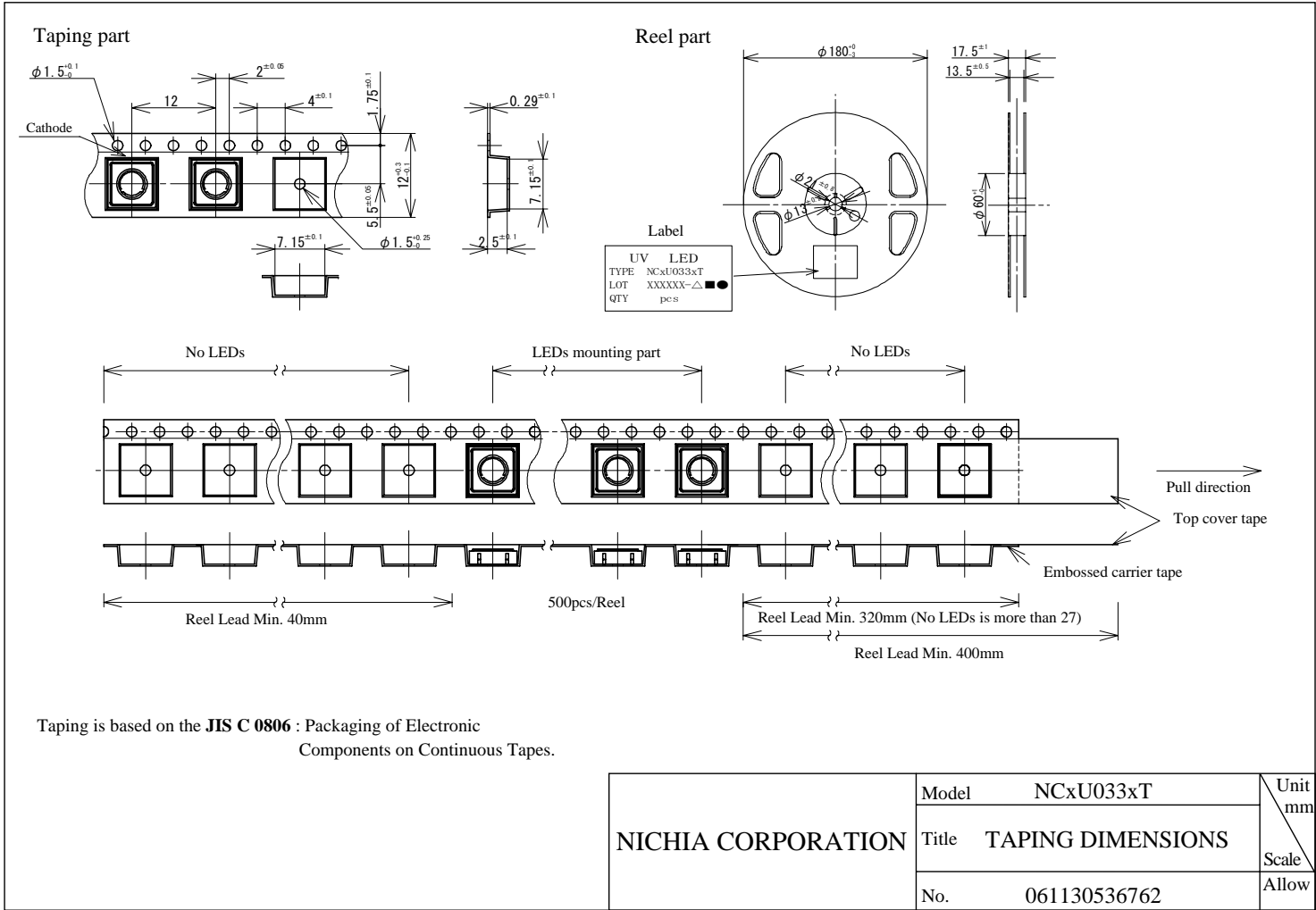

Nichia STSE-CC6130A  
 Cat.No.061218

The reel and moisture absorbent material are put in the moisture proof foil bag and then heat sealed.

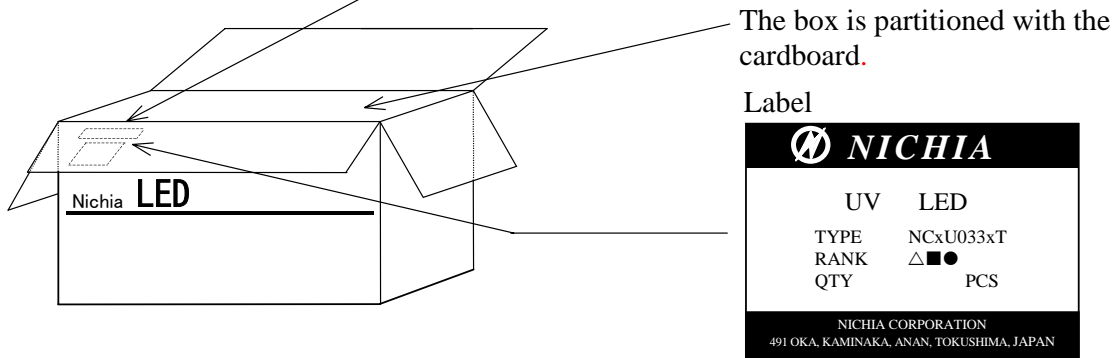
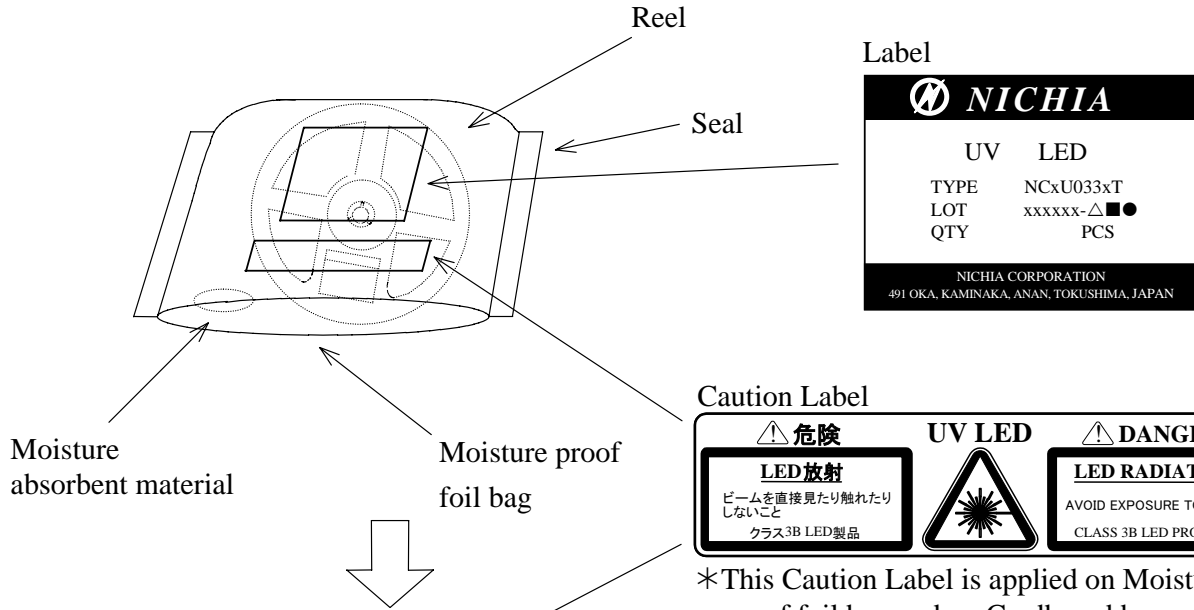

**Packing unit**

	Reel/bag	Quantity/bag (pcs)
Moisture proof foil bag	1reel	500 MAX.

Cardboard box	Dimensions (mm)	Reel/box	Quantity/box (pcs)
Cardboard box S	291×237×120×8t	5reel MAX.	2,500 MAX.
Cardboard box M	259×247×243×5t	10reel MAX.	5,000 MAX.
Cardboard box L	444×262×259×8t	20reel MAX.	10,000 MAX.

NICHIA CORPORATION	Model	NCxU033xT
	Title	PACKING
	No.	061130542462