

Secondary LDO Regulators for Local Power Supplies

Dual-output Secondary Fixed/Variable Output LDO Regulators for Local Power Supplies

BA3259HFP,BA30E00WHFP

No.09026EAT02

●Description

The BA3259HFP and BA30E00WHFP are 2-output, low-saturation regulators. These units have both a 3.3 V fixed output as well as a variable output with a voltage accuracy of $\pm 2\%$, and incorporate an overcurrent protection circuit to prevent IC destruction due to output shorting along with a TSD (Thermal Shut Down) circuit to protect the IC from thermal destruction caused by overloading.

●Features

- 1) Output voltage accuracy: $\pm 2\%$.
- 2) Reference voltage accuracy: $\pm 2\%$
- 3) Output current capacity: 1 A (BA3259HFP), 0.6 A (BA30E00WHFP)
- 4) Ceramic capacitor can be used to prevent output oscillation (BA3259HFP)
- 6) Low dissipation with two voltage input supported (BA30E00WHFP)
- 7) Built-in thermal shutdown circuit
- 8) Built-in overcurrent protection circuit

●Applications

Available to all commercial devices, such as FPD, TV, and PC sets besides DSP power supplies for DVD and CD sets.

●Product Lineup

Part Number	Output voltage Vo1	Output voltage Vo2	Output Current Io1	Output Current Io2	Package
BA3259HFP	3.3 V	0.8 V to 3.3 V	1 A max	1 A max	HRP5
BA30E00WHFP	3.3 V	0.8 V to 3.3 V	0.6 A max	0.6 A max	HRP7

●Absolute Maximum Ratings

BA3259HFP

Parameter	Symbol	Limit	Units
Applied voltage	Vcc	15 ^{*1}	V
Power dissipation	Pd	2300 ^{*2}	mW
Operating temperature range	Topr	0 to 85	°C
Ambient storage temperature range	Tstg	-55 to 150	°C
Maximum junction temperature	Tjmax	150	°C

*1 Must not exceed Pd.

*2 Derated at 18.4 mW/°C at Ta>25°C when mounted on a glass epoxy board (70 mm × 70 mm × 1.6 mm).

BA30E00WHFP

Parameter	Symbol	Limit	Units
Applied voltage	Vcc	18 ^{*1}	V
Power dissipation	Pd	2300 ^{*2}	mW
Operating temperature range	Topr	-25 to 105	°C
Ambient storage temperature range	Tstg	-55 to 150	°C
Maximum junction temperature	Tjmax	150	°C

●Recommended Operating Conditions

BA3259HFP

Parameter	Symbol	Min.	Typ.	Max.	Unit
Input power supply voltage	Vcc	4.75	-	14.0	V
3.3 V output current	Io1	-	-	1	A
Variable output current	Io2	-	-	1	A

BA30E00WHFP

Parameter	Symbol	Min.	Typ.	Max.	Unit
Input power supply voltage 1	Vcc1	4.1	-	16.0	V
Input power supply voltage 2	Vcc2	2.8	-	Vcc1	V
3.3 V output current	Io1	-	-	0.6	A
Variable output current	Io2	-	-	0.6	A

●Electrical Characteristics

BA3259HFP (Unless otherwise specified, Ta=25°C, Vcc=5 V, R1=R2=5 kΩ)

Parameter	Symbol	Min.	Typ.	Max.	Unit	Conditions
Circuit current	I _B	-	3	5	mA	Io1=0 mA, Io2=0mA
[3.3 V Output Block]						
Output voltage 1	Vo1	3.234	3.300	3.366	V	Io1=50mA
Minimum I/O voltage difference 1	ΔVd1	-	1.1	1.3	V	Io1=1 A, Vcc=3.8V
Current capability 1	Io1	1.0	-	-	A	
Ripple rejection 1	R.R.1	46	52	-	dB	f=120Hz, ein=0.5Vp-p, Io1=5mA
Input stability 1	ΔVLINE1	-	5	15	mV	Vcc=4.75→14V, Io1=5mA
Load stability 1	ΔVLOAD1	-	5	20	mV	Io1=5mA→1 A
Temperature coefficient of output voltage 1 ^{*3}	Tcvo1	-	±0.01	-	%/°C	Io1=5mA, Tj=0°C to 85°C
[Variable output]						
Reference voltage	VREF	0.784	0.800	0.816	V	Io2=50 mA
Minimum I/O voltage difference 2	ΔVd2	-	1.1	1.3	V	Io2=1 A
Current capability 2	Io2	1.0	-	-	A	
Ripple rejection 2	R.R.2	46	52	-	dB	f=120Hz, ein=0.5 Vp-p, Io2=5mA
Input stability 2	ΔVLINE2	-	5	15	mV	Vcc=4.75→14V, Io2=5mA
Load stability 2	ΔVLOAD2	-	5	20	mV	Io2=5 mA→1 A
Temperature coefficient of output voltage 2 ^{*3}	Tcvo2	-	±0.01	-	%/°C	Io2=5mA, Tj=0°C to 85°C
Variable pin current	IADJ	-	0.05	1.0	μA	VADJ=0.85V

*3: Operation is guaranteed within these parameters

BA30E00WHFP (Unless otherwise specified, Ta=25°C, Vcc1=Vcc2=VEN=5 V, R1=50 kΩ, R2=62.5 kΩ)

Parameter	Symbol	Min.	Typ.	Max.	Unit	Conditions
Bias current	I _b	-	0.7	1.6	mA	Io1=0mA, Io2=0mA
Standby current	I _{ST}	-	0	10	μA	VEN=GND
EN pin on voltage	V _{ON}	2.0	-	-	V	Active mode
EN pin off voltage	V _{OFF}	-	-	0.8	V	Standby mode
EN pin current	I _{EN}	-	50	100	μA	VEN=3.3V
[3.3 V output]						
Output voltage 1	Vo1	3.234	3.300	3.366	V	Io1=50mA
Minimum I/O voltage difference 1	ΔVd1	-	0.30	0.60	V	Io1=300mA, Vcc=3.135V
Output current capacity 1	Io1	0.6	-	-	A	
Ripple rejection 1	R.R.1	-	68	-	dB	f=120Hz, ein=1Vp-p, Io1=100mA
Input stability 1	Reg.I1	-	5	30	mV	Vcc1=4.1→16V, Io1=50mA
Load stability 1-1	Reg.L1-1	-	30	90	mV	Io1=0 mA→0.6A
Load stability 1-2	Reg.L1-2	-	30	90	mV	Vcc1=3.7V, Io1=0→0.4A
Temperature coefficient of output voltage 1 ^{*3}	Tcvo1	-	±0.01	-	%/°C	Io1=5mA, Tj=0°C to 125°C
[Variable output] (at 1.8 V)						
Reference voltage	VADJ	0.784	0.800	0.816	V	Io2=50 mA
Minimum I/O voltage difference 2	ΔVd2	-	0.30	0.60	V	At Io2=3.3V Io2=300mA, Vcc1=Vcc2=3.135V
Output current capacity 2	Io2	0.6	-	-	A	
Ripple rejection 2	R.R.2	-	66	-	dB	f=120 Hz, ein=1Vp-p, Io2=100mA
Input stability 2	Reg.I2	-	5	30	mV	Vcc1=Vcc2=4.1V→16V, Io2=50mA
Load stability 2	Reg.L2	-	30	90	mV	Io2=0mA→0.6A
Temperature coefficient of output voltage 2 ^{*3}	Tcvo2	-	±0.01	-	%/°C	Io2=5mA, Tj=0°C to 125°C

*3: Operation is guaranteed within these parameters

●BA3259HFP Electrical Characteristics Curves (Unless otherwise specified, Ta=25°C, Vcc=5 V)

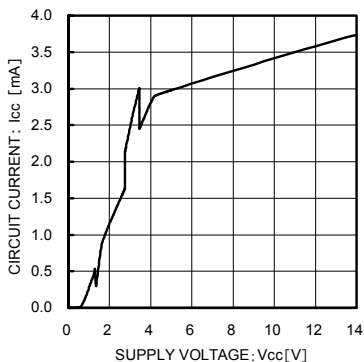

Fig.1 Circuit Current (with no load)

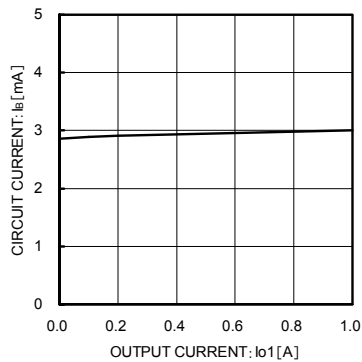

Fig.2 Circuit Current vs Load Current I_o

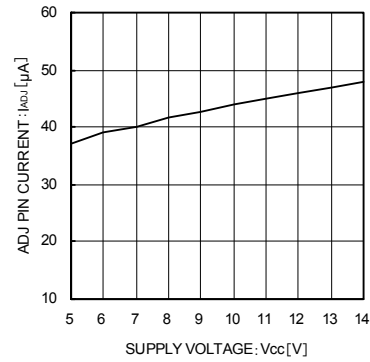

Fig.3 ADJ Pin Outflow Current

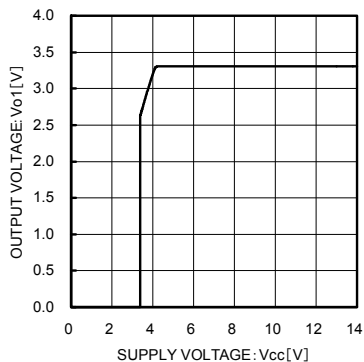

Fig.4 Input Stability (3.3 V output with no load)

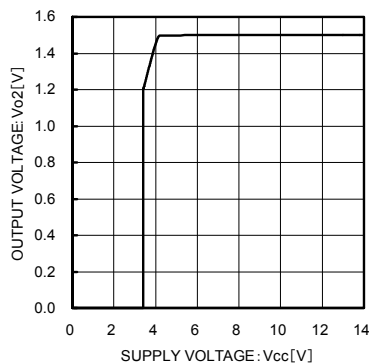

Fig.5 Input Stability (Variable output with no load)

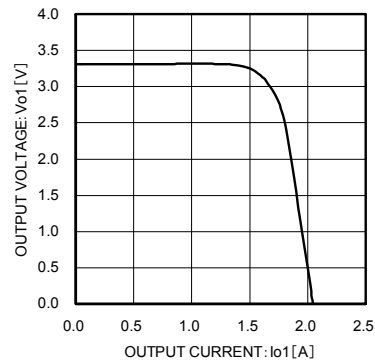

Fig.6 Load Stability (3.3 V output)

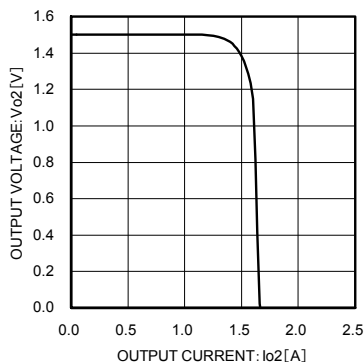

Fig.7 Load Stability (Variable output: 1.5 V)

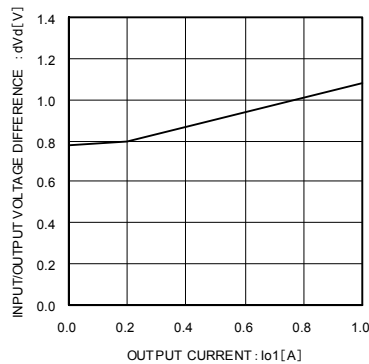

Fig.8 I/O Voltage Difference (3.3 V output) (3.3 V output, I_{o1}=0 A → 1 A)

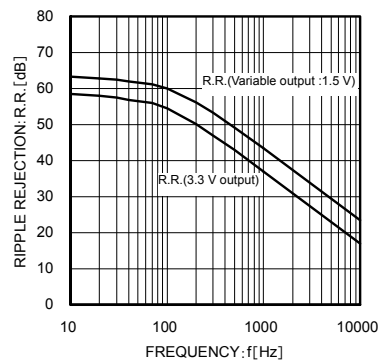

Fig.9 R.R.

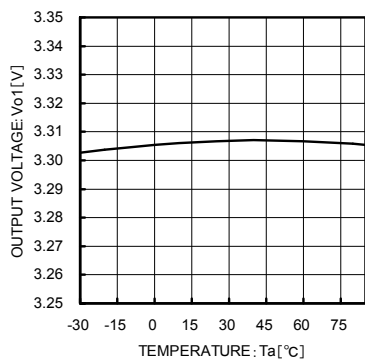

Fig.10 Output Voltage vs Temperature (3.3 V output)

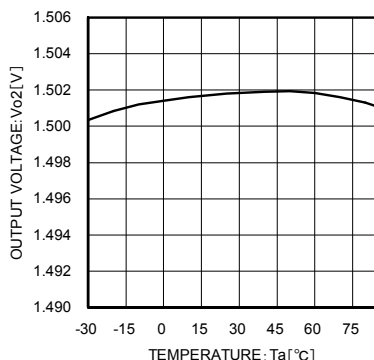

Fig.11 Output Voltage vs Temperature (Variable output: 1.5 V)

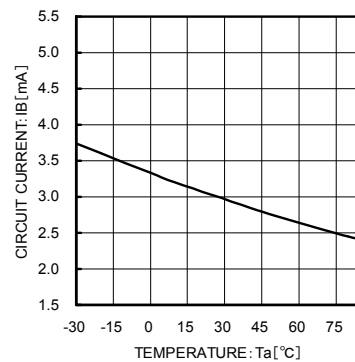

Fig.12 Circuit Current vs Temperature

●BA30E00WHFP Electrical Characteristics Curves (Unless otherwise specified, Ta=25°C, Vcc1=Vcc2=5V)

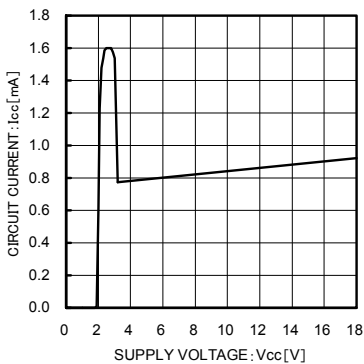

Fig. 13 Circuit Current (with no load)

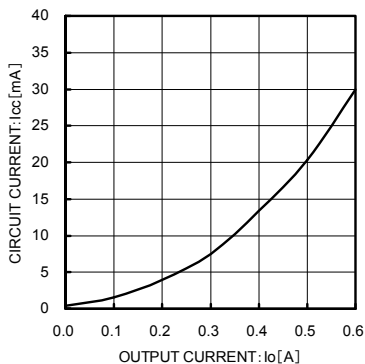

Fig. 14 Circuit Current vs Load Current I_O (I_O=0 → 600 mA)

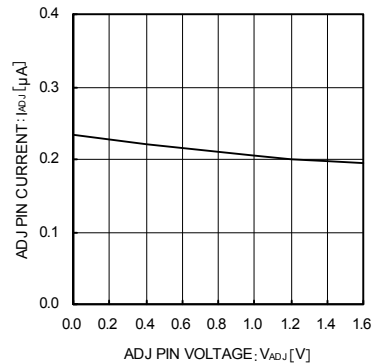

Fig. 15 ADJ Pin Source Current

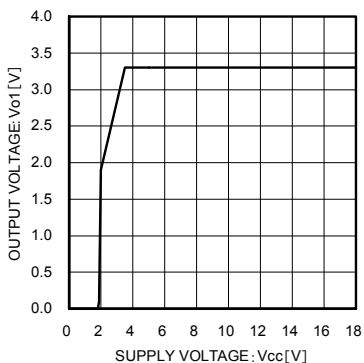

Fig. 16 Input Stability (3.3 V output I_{O1}=600 mA)

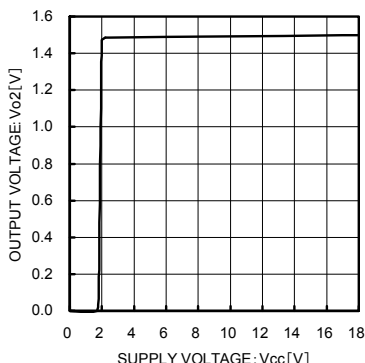

Fig. 17 Input Stability (Variable output: 1.8 V)

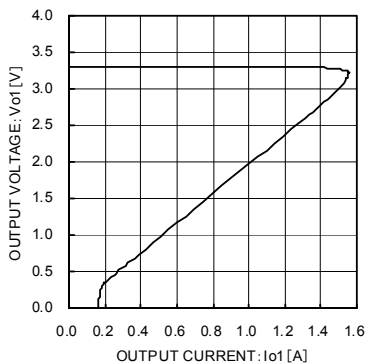

Fig. 18 Load Stability (3.3 V output)

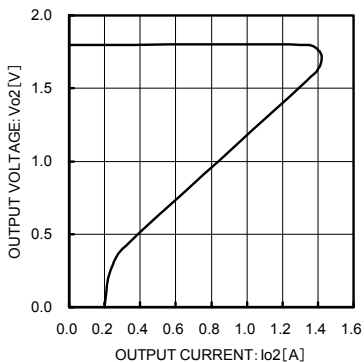

Fig. 19 Load Stability (Variable output: 1.8 V)

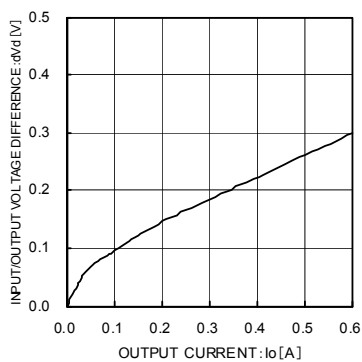

Fig. 20 I/O Voltage Difference (V_{CC}=3.135 V, 3.3 V output)

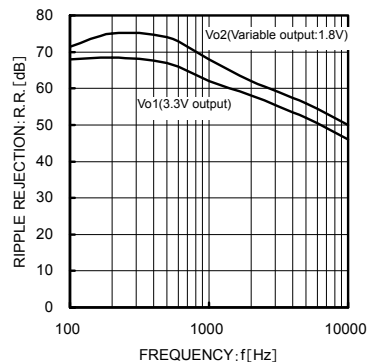

Fig. 21 R.R. (e_{in}=1 V_{p-p}, I_O=100 mA)

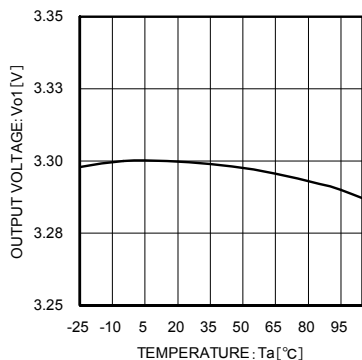

Fig. 22 Output Voltage vs Temperature (3.3 V output)

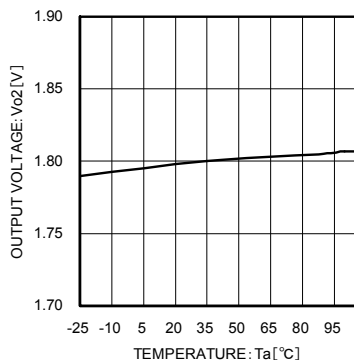

Fig. 23 Output Voltage vs Temperature (Variable output: 1.8 V)

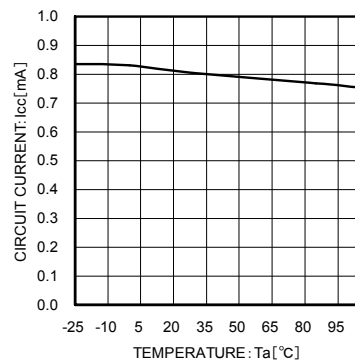

Fig. 24 Circuit Current vs Temperature (I_O=0 mA)

●Block Diagrams / Standard Example Application Circuits

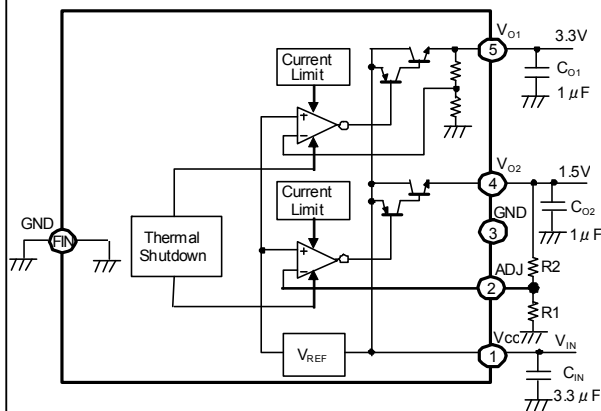

Fig.25 BA3259HFP Block Diagram

Pin No.	Pin name	Function
1	Vcc	Power supply pin
2	ADJ	Variable output voltage detection pin
3	GND	GND pin
4	Vo2	Variable output pin
5	Vo1	3.3 V output pin
FIN	GND	GND pin

PIN	External capacitor setting range
Vcc (1Pin)	Approximately 3.3 µF
Vo1 (5Pin)	1 µF to 1000 µF
Vo2 (4Pin)	1 µF to 1000 µF

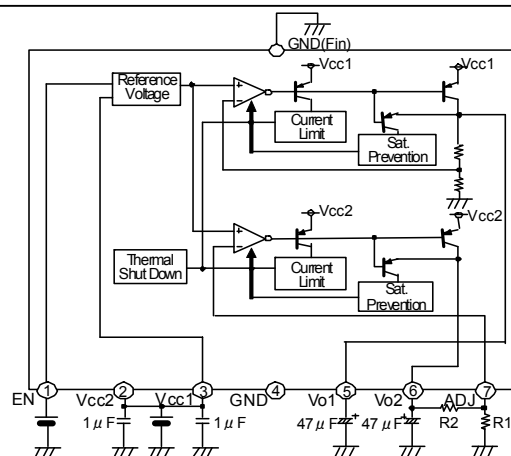
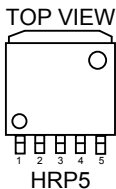
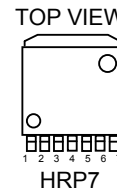

Fig.26 BA30E00WHFP Block Diagram

Pin No.	Pin name	Function
1	EN	Output on/off control pin: High active
2	Vcc2	Power supply pin 2
3	Vcc1	Power supply pin 1
4	GND	GND pin
5	Vo1	Power supply pin for 3.3 V output
6	Vo2	Variable output voltage detection pin (0.8 V to 3.3 V)
7	ADJ	Variable output voltage detection pin
FIN	GND	GND pin

PIN	External capacitor setting range
Vcc1 (3Pin)	Approximately 1 µF
Vcc2 (2Pin)	Approximately 1 µF
Vo1 (5Pin)	47 µF to 1000 µF
Vo2 (6Pin)	47 µF to 1000 µF



●Setting the Output Voltage Vo2

The following output voltage setting method applies to the variable output pin.

$$Vo2 = V_{ADJ} \times \left(1 + \frac{R2}{R1} \right) - R2 \times I_{ADJ}$$

V_{ADJ}: Output feedback reference voltage (0.8 V typ.)

I_{ADJ}: ADJ pin source current (0.05µA typ.: BA3259HFP)
(0.2µA typ.: BA30E00WHFP)

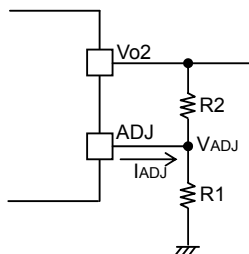

R1
BA3259HFP: 1 kΩ to 10 kΩ
BA30E00HFP: 1 kΩ to 5 kΩ
The above is recommended.

Note: Connect R1 and R2 to make output voltage settings as shown in Fig.25 and Fig.26. Keep in mind that the offset voltage caused by the current (I_{ADJ}) flowing out of the ADJ pin will become high if higher resistance is used.

●Function Explanation

1) Two-input power supply (BA30E00WHFP)

The input voltages (Vcc1 and Vcc2) supply power to two outputs (Vo1 and Vo2, respectively). The power dissipation between the input and output pins can be suppressed for each output according to usage.

Efficiency comparison:

5V single input vs. 5V/3V two inputs

●Regulator with single input and two outputs

●Regulator with two inputs and two outputs
(Vo2=1.8V, Io1=Io2=0.3A)

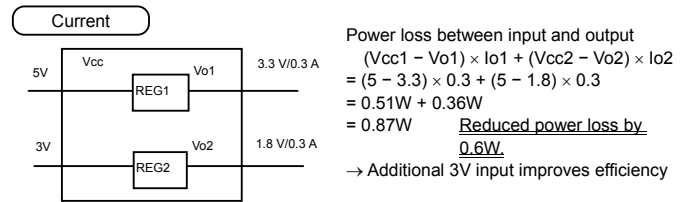
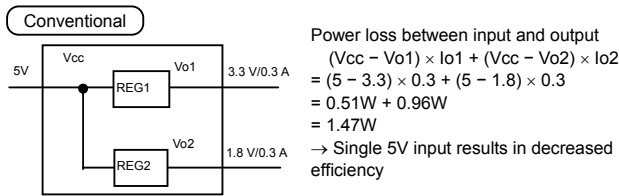

2) Standby function (BA30E00WHFP)

The standby function is operated through the EN pin. Output is turned on at 2.0 V or higher and turned off at 0.8 V or lower.

●Thermal Design

If the IC is used under the conditions of excess of the power dissipation, the chip temperature will rise, which will have an adverse effect on the electrical characteristics of the IC, such as a reduction in current capability. Furthermore, if the temperature exceeds T_{jmax} , element deterioration or damage may occur. Implement proper thermal designs to ensure that the power dissipation is within the permissible range in order to prevent instantaneous IC damage resulting from heat and maintain the reliability of the IC for long-term operation. Refer to the power derating characteristics curves in Fig. 27.

●Power Consumption Pc (W) Calculation Method:

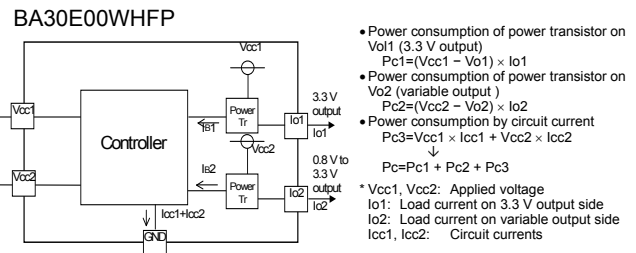
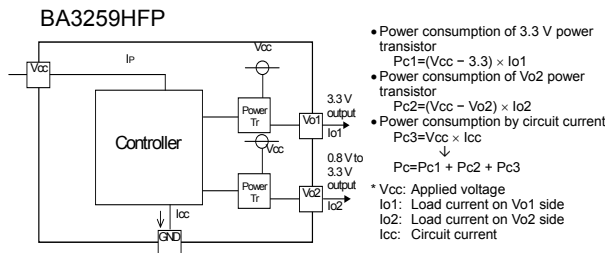

The Icc (circuit current) varies with the load.

Refer to the above and implement proper thermal designs so that the IC will not be used under conditions of excess power dissipation Pd under all operating temperatures.

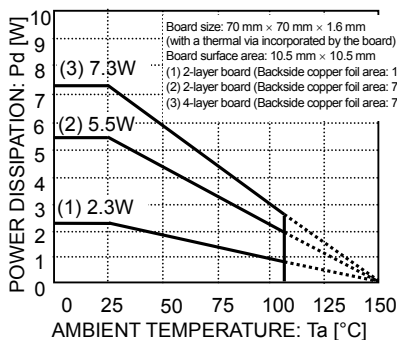

Fig. 27 Ambient Temperature vs. Power Dissipation

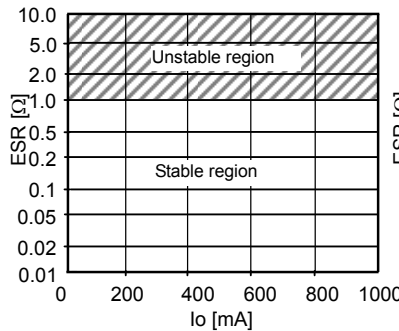

Fig.28 BA3259HFP ESR

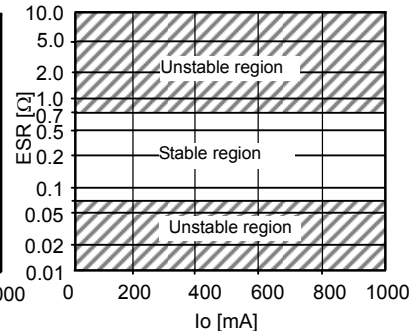

Fig.29 BA30E00WHFP ESR

● Input / Output Equivalent Circuits

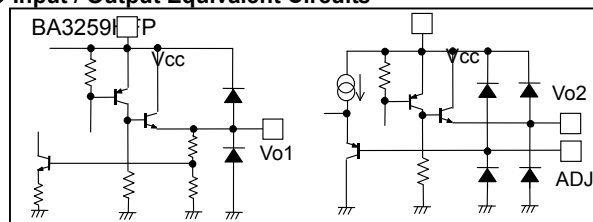

Fig.30 BA3259HFP I/O Equivalent Circuits

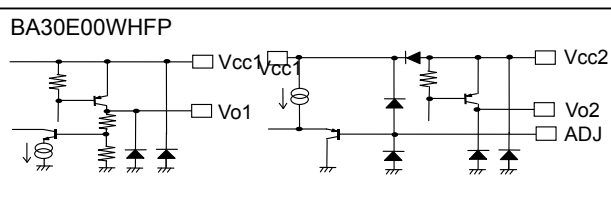

Fig.31 BA30E00WHFP I/O Equivalent Circuit

● Explanation of external components

● BA3259HFP

1) Vcc (Pin 1)

It is recommended that a ceramic capacitor with a capacitance of approximately $3.3\mu\text{F}$ is placed between Vcc and GND at a position closest to the pins as possible.

2) Vo (Pins 4 and 5)

Insert a capacitor between Vo and GND in order to prevent output oscillation. The capacitor may oscillate if the capacitance changes as a result of temperature fluctuations. Therefore, it is recommended that a ceramic capacitor with a temperature coefficient of X5R or above and a maximum capacitance change (resulting from temperature fluctuations) of $\pm 10\%$ be used. The capacitance should be between $1\mu\text{F}$ and $1,000\mu\text{F}$. (Refer to Fig. 28.)

● BA30E00HFP

1) Vcc1 (Pin 3) and Vcc2 (Pin 2)

Insert capacitors with a capacitance of $1\mu\text{F}$ between Vcc1 and GND and Vcc2 and GND. The capacitance value will vary depending on the application. Be sure to implement designs with sufficient margins.

2) Vo1 (Pin 5) and Vo2 (Pin 6)

Insert a capacitor between Vo and GND in order to prevent oscillation. The capacitance of the capacitor may greatly vary with temperature changes, making it impossible to completely prevent oscillation. Therefore, use a tantalum aluminum electrolytic capacitor with a low ESR (Equivalent Serial Resistance) that ensures good performance characteristics at low temperatures. The output oscillates if the ESR is too high or too low. Refer to the ESR characteristics in Fig. 29 and operate the IC within the stable operating region. If there is a sudden load change, use a capacitor with a higher capacitance. A capacitance between $47\mu\text{F}$ and $1,000\mu\text{F}$ is recommended.

● Notes for use

1) Absolute maximum ratings

An excess in the absolute maximum ratings, such as supply voltage, temperature range of operating conditions, etc., can break down the devices, thus making impossible to identify breaking mode, such as a short circuit or an open circuit. If any over rated values will expect to exceed the absolute maximum ratings, consider adding circuit protection devices, such as fuses.

2) GND voltage

The potential of GND pin must be minimum potential in all operating conditions.

3) Thermal design

Use a thermal design that allows for a sufficient margin in light of the power dissipation (P_d) in actual operating conditions.

4) Inter-pin shorts and mounting errors

Use caution when positioning the IC for mounting on printed circuit boards. The IC may be damaged if there is any connection error or if pins are shorted together.

5) Actions in strong electromagnetic field

Use caution when using the IC in the presence of a strong electromagnetic field as doing so may cause the IC to malfunction.

6) Testing on application boards

When testing the IC on an application board, connecting a capacitor to a pin with low impedance subjects the IC to stress. Always discharge capacitors after each process or step. Always turn the IC's power supply off before connecting it to or removing it from a jig or fixture during the inspection process. Ground the IC during assembly steps as an antistatic measure. Use similar precaution when transporting or storing the IC.

7) Regarding input pin of the IC

This monolithic IC contains P+ isolation and P substrate layers between adjacent elements in order to keep them isolated. P-N junctions are formed at the intersection of these P layers with the N layers of other elements, creating a parasitic diode or transistor. For example, the relation between each potential is as follows:

When $GND > Pin A$ and $GND > Pin B$, the P-N junction operates as a parasitic diode.

When $GND > Pin B$, the P-N junction operates as a parasitic transistor.

Parasitic diodes can occur inevitable in the structure of the IC. The operation of parasitic diodes can result in mutual interference among circuits, operational faults, or physical damage. Accordingly, methods by which parasitic diodes operate, such as applying a voltage that is lower than the GND (P substrate) voltage to an input pin, should not be used.

8) Ground wiring patterns

When using both small signal and large current GND patterns, it is recommended to isolate the two ground patterns, placing a single ground point at the ground potential of application so that the pattern wiring resistance and voltage variations caused by large currents do not cause variations in the small signal ground voltage. Be careful not to change the GND wiring pattern of any external components, either.

9) Thermal Shutdown Circuit (TSD)

This IC incorporates a built-in thermal shutdown circuit for protection against thermal destruction. Should the junction temperature (T_j) reach the thermal shutdown ON temperature threshold, the TSD will be activated, turning off all output power elements. The circuit will automatically reset once the chip's temperature T_j drops below the threshold temperature. Operation of the thermal shutdown circuit presumes that the IC's absolute maximum ratings have been exceeded. Application designs should never make use of the thermal shutdown circuit.

10) Overcurrent protection circuit

An overcurrent protection circuit is incorporated in order to prevention destruction due to short-time overload currents. Continued use of the protection circuits should be avoided. Please note that current increases negatively impact the temperature.

11) Damage to the internal circuit or element may occur when the polarity of the Vcc pin is opposite to that of the other pins in applications. (I.e. Vcc is shorted with the GND pin while an external capacitor is charged.)

Use a maximum capacitance of 1000 mF for the output pins. Inserting a diode to prevent back-current flow in series with Vcc or bypass diodes between Vcc and each pin is recommended.

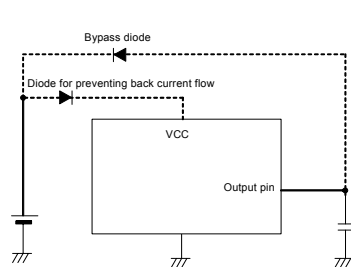

Fig. 32 Bypass diode

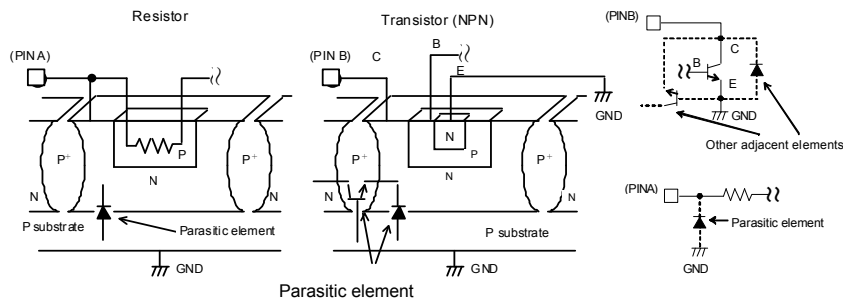

Fig. 33 Example of Simple Bipolar IC Architecture

B A

3 2 5 9

H F P -

T R

Part No.

Part No.
3259
30E00W

Package
HFP: HRP5
HRP7

Packaging and forming specification
TR: Embossed tape and reel
(HRP5, HRP7)

HRP5

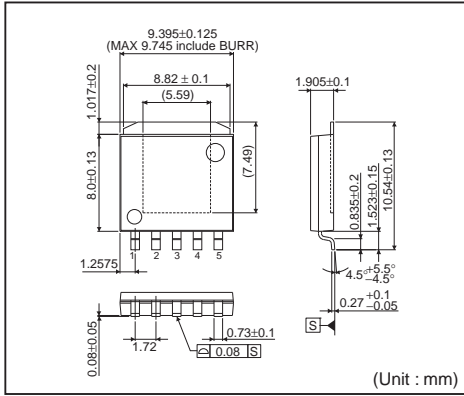

<Tape and Reel information>

Tape	Embossed carrier tape
Quantity	2000pcs
Direction of feed	TR (The direction is the 1pin of product is at the upper right when you hold reel on the left hand and you pull out the tape on the right hand)

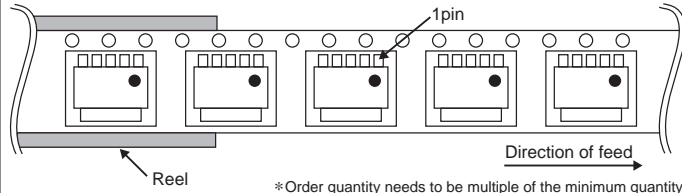

HRP7

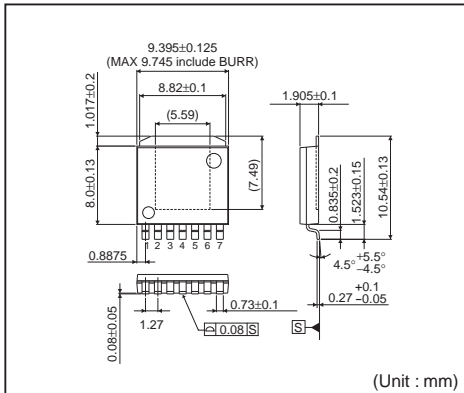

<Tape and Reel information>

Tape	Embossed carrier tape
Quantity	2000pcs
Direction of feed	TR (The direction is the 1pin of product is at the upper right when you hold reel on the left hand and you pull out the tape on the right hand)

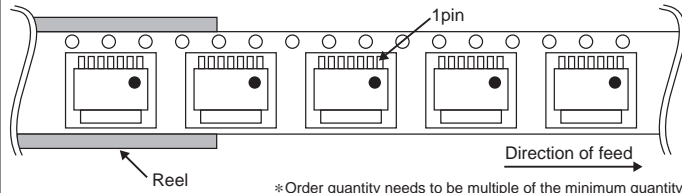

Notes

No copying or reproduction of this document, in part or in whole, is permitted without the consent of ROHM Co.,Ltd.

The content specified herein is subject to change for improvement without notice.

The content specified herein is for the purpose of introducing ROHM's products (hereinafter "Products"). If you wish to use any such Product, please be sure to refer to the specifications, which can be obtained from ROHM upon request.

Examples of application circuits, circuit constants and any other information contained herein illustrate the standard usage and operations of the Products. The peripheral conditions must be taken into account when designing circuits for mass production.

Great care was taken in ensuring the accuracy of the information specified in this document. However, should you incur any damage arising from any inaccuracy or misprint of such information, ROHM shall bear no responsibility for such damage.

The technical information specified herein is intended only to show the typical functions of and examples of application circuits for the Products. ROHM does not grant you, explicitly or implicitly, any license to use or exercise intellectual property or other rights held by ROHM and other parties. ROHM shall bear no responsibility whatsoever for any dispute arising from the use of such technical information.

The Products specified in this document are intended to be used with general-use electronic equipment or devices (such as audio visual equipment, office-automation equipment, communication devices, electronic appliances and amusement devices).

The Products specified in this document are not designed to be radiation tolerant.

While ROHM always makes efforts to enhance the quality and reliability of its Products, a Product may fail or malfunction for a variety of reasons.

Please be sure to implement in your equipment using the Products safety measures to guard against the possibility of physical injury, fire or any other damage caused in the event of the failure of any Product, such as derating, redundancy, fire control and fail-safe designs. ROHM shall bear no responsibility whatsoever for your use of any Product outside of the prescribed scope or not in accordance with the instruction manual.

The Products are not designed or manufactured to be used with any equipment, device or system which requires an extremely high level of reliability the failure or malfunction of which may result in a direct threat to human life or create a risk of human injury (such as a medical instrument, transportation equipment, aerospace machinery, nuclear-reactor controller, fuel-controller or other safety device). ROHM shall bear no responsibility in any way for use of any of the Products for the above special purposes. If a Product is intended to be used for any such special purpose, please contact a ROHM sales representative before purchasing.

If you intend to export or ship overseas any Product or technology specified herein that may be controlled under the Foreign Exchange and the Foreign Trade Law, you will be required to obtain a license or permit under the Law.



Thank you for your accessing to ROHM product informations.
More detail product informations and catalogs are available, please contact us.

ROHM Customer Support System

<http://www.rohm.com/contact/>