

MAPDCT0033



2 Way 0° Power Divider
5-1000MHz

M/A-COM Products
Rev. V2

Features

- Surface Mount
- 2 Way 0 degree
- 260°C Reflow Compatible
- RoHS* Compliant
- RoHS version of ELPD-20-1
- Available on Tape and Reel. Reel quantity 900

Description

M/A-COM's MAPDCT0033 is 2 way 0 degree RF power divider in a low cost, surface mount package. Ideally suited for high volume CATV/Broadband applications.



Pin Configuration

Pin No.	Function
1	Ground
2	Not connected (ground)
3	Output 1
4	Output 2
5	Not connected (ground)
6	Input

Ordering Information

Part Number	Package
MAPDCT0033	900 piece reel
MAPD-008086-CT33TB	Customer test board

Note: Reference Application Note **M513** for reel size information.

* Restrictions on Hazardous Substances, European Union Directive 2002/95/EC.

Schematic

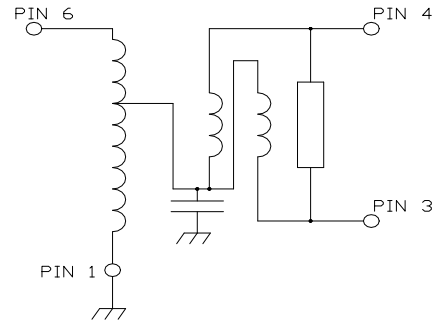

Case Style: SM-139

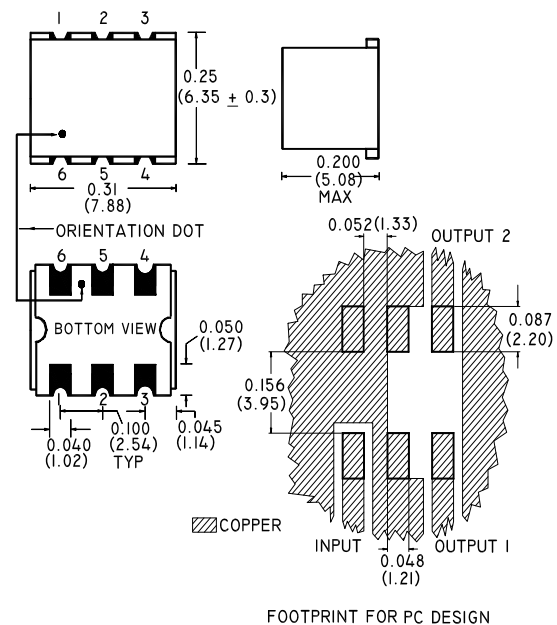

Dimensions in inches [mm] Tolerance: .xx ± .02, .xxx ± .010

ADVANCED: Data Sheets contain information regarding a product M/A-COM Technology Solutions is considering for development. Performance is based on target specifications, simulated results, and/or prototype measurements. Commitment to develop is not guaranteed.

PRELIMINARY: Data Sheets contain information regarding a product M/A-COM Technology Solutions has under development. Performance is based on engineering tests. Specifications are typical. Mechanical outline has been fixed. Engineering samples and/or test data may be available. Commitment to produce in volume is not guaranteed.

• **North America** Tel: 800.366.2266 • **Europe** Tel: +353.21.244.6400
 • **India** Tel: +91.80.4155721 • **China** Tel: +86.21.2407.1588
 Visit www.macomtech.com for additional data sheets and product information.

M/A-COM Technology Solutions Inc. and its affiliates reserve the right to make changes to the product(s) or information contained herein without notice.

Electrical Specifications: $T_A = 25^\circ\text{C}$, $Z_0 = 75\Omega$ ¹

Parameter	Frequency	Units	Min	Typ	Max
Insertion Loss	5 - 50 MHz	dB	-	0.2	0.5
	50 - 500 MHz	dB	-	0.5	0.8
	500 - 1000 MHz	dB	-	1.0	1.3
Amplitude Unbalance (Nominal 0dB)	5 - 50 MHz	dB	-	0.0	± 0.1
	50 - 500 MHz	dB	-	0.0	± 0.3
	500 - 1000 MHz	dB	-	0.1	± 0.5
Phase Unbalance (Nominal 0°)	5 - 50 MHz	°	-	0.0	± 1.0
	50 - 500 MHz	°	-	0.4	± 3.0
	500 - 1000 MHz	°	-	0.8	± 4.0
Return Loss: Input	5 - 750 MHz	dB	18	35	-
	750 - 1000 MHz	dB	12	25	-
Return Loss: Output	5 - 750 MHz	dB	18	22	-
	750 - 1000 MHz	dB	15	24	-
Isolation (between outputs)	5 - 50 MHz	dB	22	26	-
	50 - 500 MHz	dB	22	29	-
	500 - 1000 MHz	dB	18	22	-

Absolute Maximum Ratings^{1,2}

Parameter	Absolute Maximum
Max Input Power	1W
DC current	240mA
Operating Temperature	-40°C to +85°C
Storage Temperature	-55°C to +100°C

- Exceeding any one or combination of these limits may cause permanent damage to this device.
- M/A-COM does not recommend sustained operation near these survivability limits.

Recommended PCB Configuration

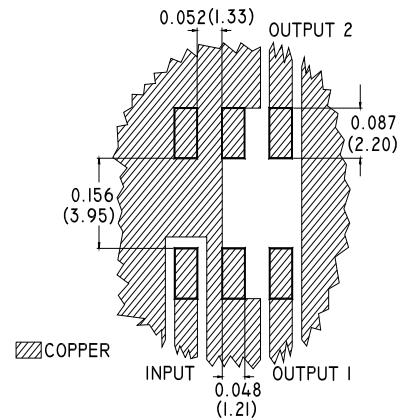

2

ADVANCED: Data Sheets contain information regarding a product M/A-COM Technology Solutions is considering for development. Performance is based on target specifications, simulated results, and/or prototype measurements. Commitment to develop is not guaranteed.
PRELIMINARY: Data Sheets contain information regarding a product M/A-COM Technology Solutions has under development. Performance is based on engineering tests. Specifications are typical. Mechanical outline has been fixed. Engineering samples and/or test data may be available. Commitment to produce in volume is not guaranteed.

• **North America** Tel: 800.366.2266 • **Europe** Tel: +353.21.244.6400
 • **India** Tel: +91.80.4155721 • **China** Tel: +86.21.2407.1588
 Visit www.macomtech.com for additional data sheets and product information.

M/A-COM Technology Solutions Inc. and its affiliates reserve the right to make changes to the product(s) or information contained herein without notice.

MAPDCT0033



2 Way 0° Power Divider
5-1000MHz

M/A-COM Products
Rev. V2

Typical Performance Curves: $T_A = 25^\circ\text{C}$, $Z_0 = 75\Omega$ ¹

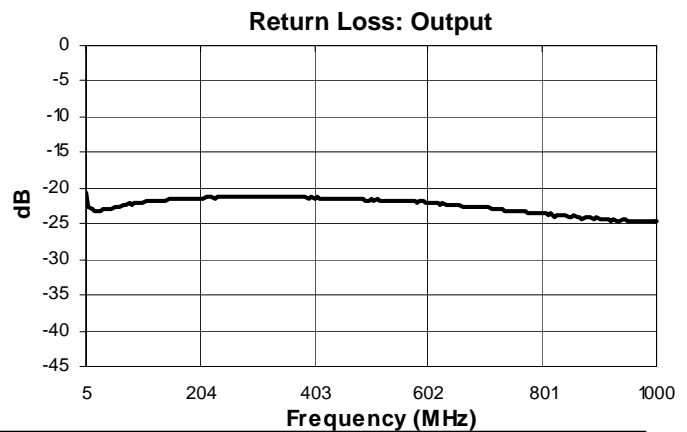
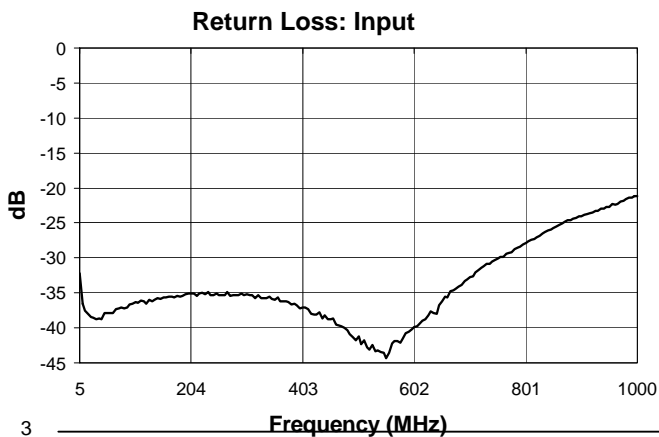
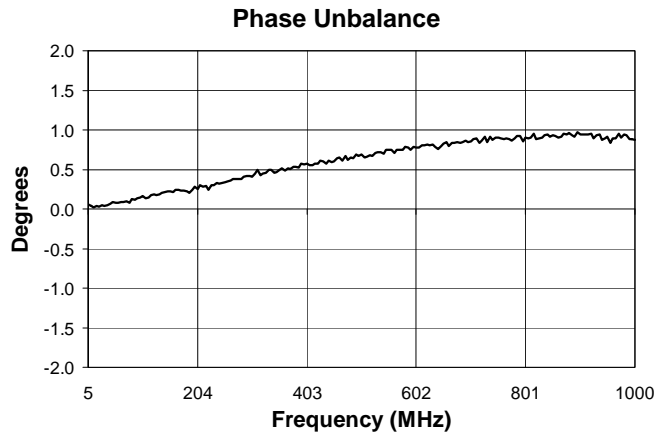
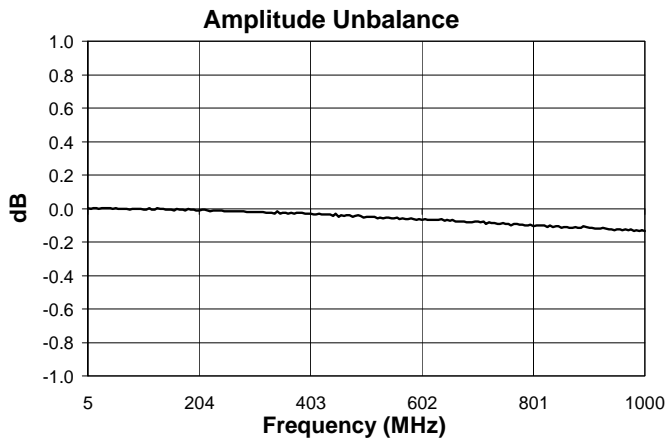
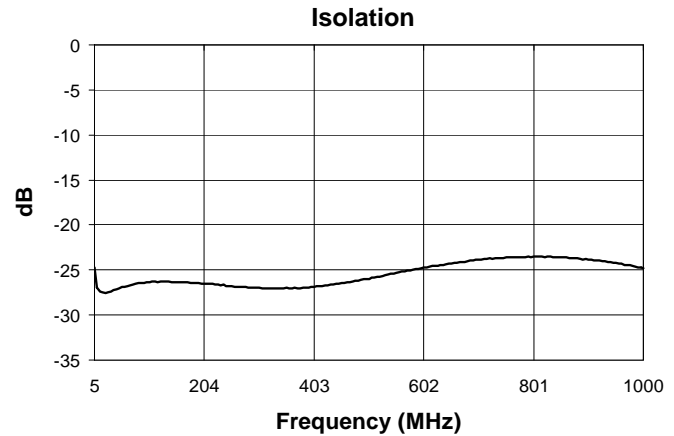

3

ADVANCED: Data Sheets contain information regarding a product M/A-COM Technology Solutions is considering for development. Performance is based on target specifications, simulated results, and/or prototype measurements. Commitment to develop is not guaranteed.
PRELIMINARY: Data Sheets contain information regarding a product M/A-COM Technology Solutions has under development. Performance is based on engineering tests. Specifications are typical. Mechanical outline has been fixed. Engineering samples and/or test data may be available. Commitment to produce in volume is not guaranteed.

• North America Tel: 800.366.2266 • Europe Tel: +353.21.244.6400
• India Tel: +91.80.4155721 • China Tel: +86.21.2407.1588
Visit www.macomtech.com for additional data sheets and product information.

M/A-COM Technology Solutions Inc. and its affiliates reserve the right to make changes to the product(s) or information contained herein without notice.