

6 - 18 GHz Power Amplifier

TGA8014-SCC

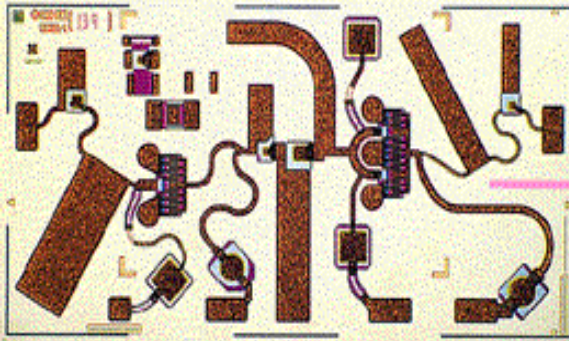

Key Features and Performance

- 6 to 18 GHz Frequency Range
- 11 dB Typical Gain
- Greater Than 0.5 Watt Output Power at 1 dB Gain Compression
- Designed for Balanced Configuration
- Unconditionally Stable
- 3.6068 x 1.9304 x 0.1016 mm (0.142 x 0.076 x 0.004 in.)

Description

The TriQuint TGA8014-SCC is a two-stage GaAs monolithic medium power amplifier. Reactively matched 914 μm and 1219 μm FETS provide 11 dB nominal gain with 16 percent typical power-added efficiency and output power at 1 dB gain compression of 0.5 watt. Ground is provided to the circuitry through vias to the backside metallization.

The small size and inherent reliability advantages of a monolithic device over a hybrid design make this device attractive for use in a variety of military applications. Used in a balanced configuration, the TGA8014-SCC effectively addresses applications such as driver and power stages in EW amplifiers, local oscillator buffers, and TWT replacement amplifiers.

Bond pad and backside metallization is gold plated for compatibility with eutectic alloy attachment methods as well as the thermocompression and thermosonic wire-bonding processes. The TGA8014-SCC is supplied in chip form and is readily assembled using automated equipment.

**TYPICAL
OUTPUT POWER**
 P_{1dB}

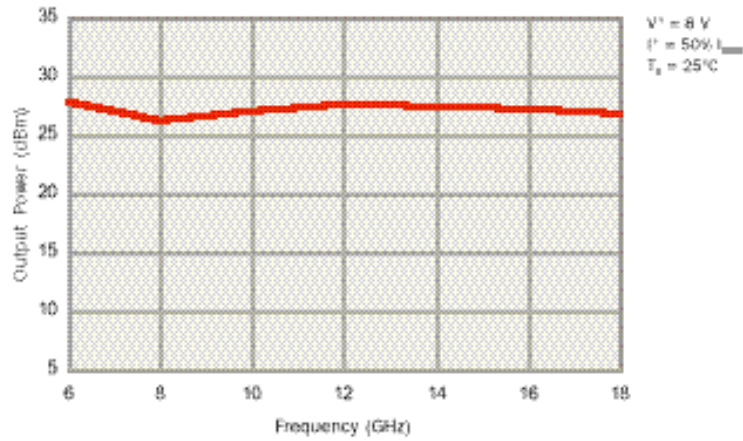

**TYPICAL
SMALL-SIGNAL
POWER GAIN**

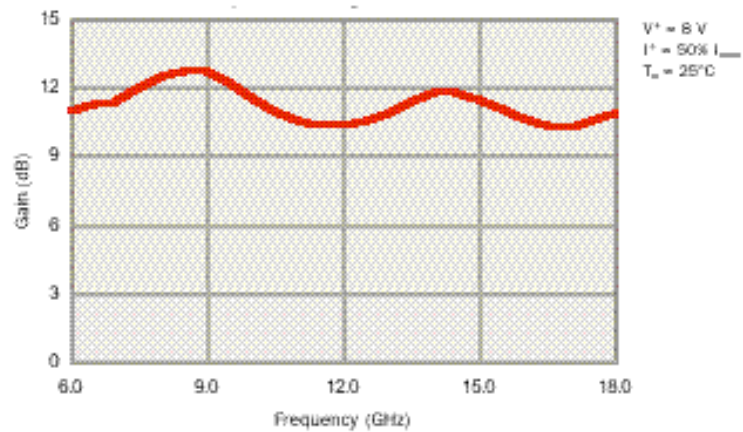

**TYPICAL
RETURN LOSS**

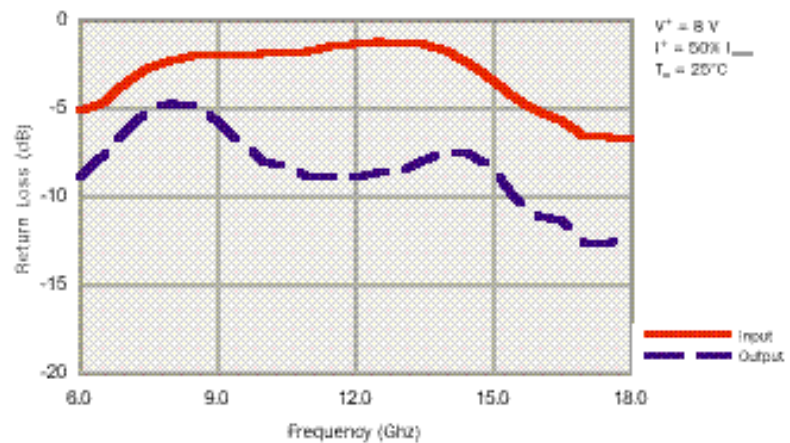

**ABSOLUTE
MAXIMUM RATINGS**

Positive supply voltage, V^+	8.5 V
Positive supply current (50% I_{DSS}), I^+	320 mA to 462 mA
Negative supply voltage range, V^-	-5 V to 0 V
Power dissipation, P_D , at (or below) 25°C base-plate temperature*	5 W
input continuous wave power, P_{IN}	28 dBm
Operating channel temperature, T_{CH}^{**}	150°C
Mounting temperature (30 sec), T_M	320°C
Storage temperature range, T_{STG}	-65 to 150°C

Ratings over operating channel temperature range, T_{CH} (unless otherwise noted)

Stresses beyond those listed under "Absolute Maximum Ratings" may cause permanent damage to the device. These are stress ratings only, and functional operation of the device at these or any other conditions beyond those indicated under "RF Characteristics" is not implied. Exposure to absolute maximum rated conditions for extended periods may affect device reliability.

* For operation above 25°C base-plate temperature, derate linearly at the rate of 10.8 mW/°C.

** Operating channel temperature directly affects the device MTTF. For maximum life, it is recommended that channel temperature be maintained at the lowest possible level.

TYPICAL S-PARAMETERS

FREQUENCY (GHz)	S ₁₁		S ₂₁		S ₁₂		S ₂₂		GAIN (dB)
	MAG	ANG	MAG	ANG	MAG	ANG	MAG	ANG	
6.0	0.55	176	3.55	29	0.002	167	0.36	4	11.0
6.5	0.58	173	3.69	-34	0.005	150	0.41	-35	11.3
7.0	0.66	168	3.73	-80	0.006	135	0.48	-73	11.4
7.5	0.73	160	3.98	-120	0.008	119	0.55	-105	12.0
8.0	0.77	150	4.25	-159	0.010	96	0.58	-135	12.6
8.5	0.79	142	4.36	163	0.010	77	0.57	-160	12.8
9.0	0.79	134	4.31	127	0.009	54	0.52	179	12.7
9.5	0.79	127	4.09	93	0.008	33	0.45	164	12.2
10.0	0.80	120	3.81	62	0.006	10	0.40	153	11.6
10.5	0.81	113	3.55	33	0.005	-10	0.38	143	11.0
11.0	0.82	105	3.39	8	0.004	-42	0.36	131	10.6
11.5	0.84	97	3.32	-18	0.004	-82	0.36	119	10.4
12.0	0.85	87	3.32	-42	0.004	-122	0.36	105	10.4
12.5	0.87	77	3.40	-68	0.005	-133	0.37	87	10.6
13.0	0.86	66	3.49	-94	0.006	-152	0.37	70	10.8
13.5	0.85	54	3.70	-121	0.010	180	0.40	52	11.4
14.0	0.82	40	3.89	-151	0.011	155	0.42	30	11.8
14.5	0.76	27	3.92	178	0.012	136	0.42	8	11.9
15.0	0.68	14	3.78	146	0.014	111	0.38	-13	11.6
15.5	0.60	6	3.59	118	0.014	78	0.31	-27	11.1
16.0	0.55	-4	3.43	89	0.015	39	0.28	-37	10.7
16.5	0.52	-16	3.32	59	0.010	-8	0.27	-51	10.4
17.0	0.47	-26	3.28	32	0.009	-4	0.23	-68	10.3
17.5	0.47	-43	3.39	1	0.017	-40	0.23	-88	10.6
18.0	0.46	-69	3.50	-34	0.017	-82	0.25	-119	10.9

T_A = 25°C, V₊ = 8 V, I₊ = 50% I_{DSS}

Reference planes for S-parameter data include bond wires as specified in the "Recommended Assembly Diagram." The S-parameters are also available on floppy disk and the world wide web.

RF CHARACTERISTICS

PARAMETER		TEST CONDITIONS	TYP	UNIT
G _p	Power gain	f = 6 to 18 GHz	11	dB
SWR (in)	Input standing wave ratio	f = 6 to 18 GHz	4.5:1	*
SWR (out)	Output standing wave ratio	f = 6 to 18 GHz	2.2:1	-
P _{1dB}	Output power at 1-dB gain compression	f = 6 to 18 GHz	27	dBm
IP ₃	Output third-order intercept point	f = 10 GHz	36.7	dBm
		f = 18 GHz	36.7	

T_A = 25°C, V₊ = 8 V, I₊ = 50% I_{DSS}

* The TGA8014-SCC is intended strictly for use in a balanced configuration.

THERMAL INFORMATION

PARAMETER	TEST CONDITION	NOM	UNIT
$R_{\theta JC}$ Thermal resistance (channel to backside)	$V^+ = 8\text{ V}$, $I^+ = 50\% I_{DSS}$	30	°C/W

EQUIVALENT SCHEMATIC

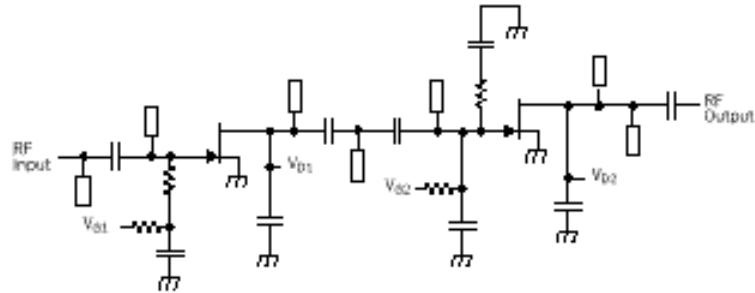

**RECOMMENDED
ASSEMBLY DIAGRAM**

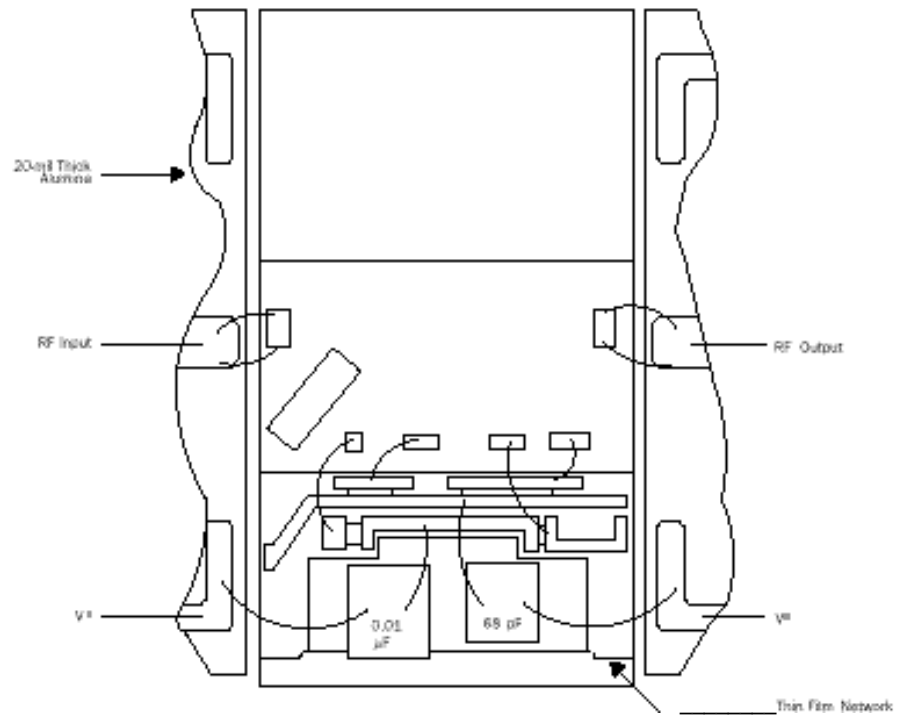

RF connections: Bond two 1-mil diameter, 25-mil-length gold bond wires at both RF Input and RF Output for optimum RF performance.

Close placement of external components is essential to stability.

Refer to TriQuint's Recommended Assembly Instructions for GaAs Products.

MECHANICAL DRAWING

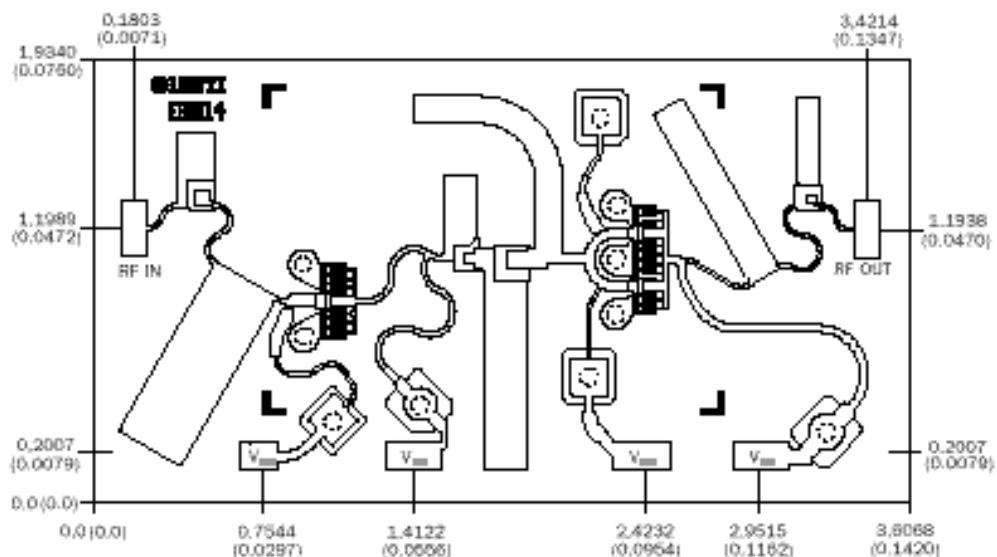

Units: Millimeters (inches)
 Thickness: 0,1016 (0,004) (reference only)
 Chip edge to bond pad dimensions are shown to center of bond pad.
 Chip size ±0,0508 (0,002)

Bond pad RF In:	0,119 x 0,246 (0,0047 x 0,0097)	Bond pad V _{DD2} :	0,246 x 0,119 (0,0097 x 0,0047)
Bond pad RF Out:	0,119 x 0,246 (0,0047 x 0,0097)	Bond pad V _{DD1} :	0,246 x 0,119 (0,0097 x 0,0047)
Bond pad V _{DD1} :	0,119 x 0,119 (0,0047 x 0,0047)	Bond pad V _{DD3} :	0,246 x 0,119 (0,0097 x 0,0047)

GaAs MMIC devices are susceptible to damage from Electrostatic Discharge. Proper precautions should be observed during handling, assembly and test.