

<b>SANYO</b>	No.2256C	<b>LA4495, 4496</b>
		Monolithic Linear IC Car Stereo-Use BTL-OCL 20W AF Power Amp

**Features**

- High output
- Low distortion
- Excellent ripple rejection
- Low residual noise
- Low pop noise at the time of power ON/OFF
- Small-sized package SEP-14HS (Zigzag pins)
- Pin compatible with LA4475, 4476

**Functions**

- Standby circuit (Standby current : 1 $\mu$ A typ.)
- Pop noise preventer (Starting time : 0.6 to 0.8sec.)
- Thermal shutdown protector
- Overvoltage/surge protector
- Output pin-to-GND short protector (with speaker protection)
- Output pin-to-V<sub>CC</sub> short protector (with speaker protection)
- Load short protector

**Maximum Ratings at Ta = 25°C**

			unit
Maximum Supply Voltage	V <sub>CC</sub> max	Quiescent, t = 30sec	26 V
	V <sub>CC</sub> max	Quiescent	18 V
	V <sub>CC</sub> max	Operating	16 V
	V <sub>CC</sub> surge	t ≤ 0.2sec, single giant pulse rise time 1msec	50 V
Surge Supply Voltage			
Output Current	I <sub>o</sub>		4 A
Thermal Resistance	$\theta_{j-c}$		3 °C/W
Junction Temperature	T <sub>j</sub>		150 °C
Allowable Power Dissipation	P <sub>d</sub> max		15 W
Operating Temperature	T <sub>opg</sub>		-20 to +75 °C
Storage Temperature	T <sub>stg</sub>		-40 to +150 °C

Information (including circuit diagrams and circuit parameters) herein is for example only; it is not guaranteed for volume production. SANYO believes information herein is accurate and reliable, but no guarantees are made or implied regarding its use or any infringements of intellectual property rights or other rights of third parties.

**Case Outline 3082-S14HIC**  
(unit: mm)

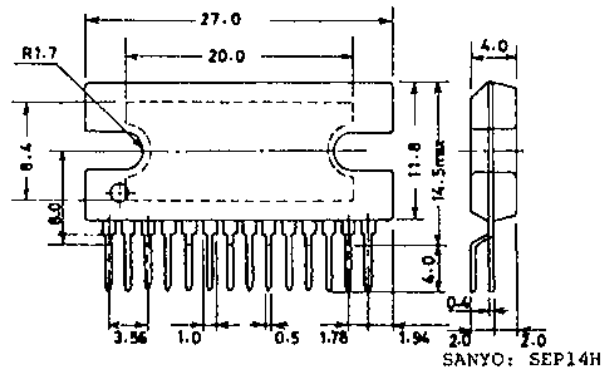

Specifications and information herein are subject to change without notice.

**SANYO Electric Co., Ltd. Semiconductor Business Headquarters**  
TOKYO OFFICE Tokyo Bldg., 1-10, 1 Chome, Ueno, Taito-ku, TOKYO, 110 JAPAN

1278TA/9126AT, TS No.2256-1/13

LA4495,4496

Operating Conditions at  $T_a = 25^\circ\text{C}$

Recommended Supply Voltage	$V_{CC}$	13.2	V
Recommended Load Resistance	$R_L$	4	$\Omega$
Operating Voltage Range	$V_{CC\text{op}}$	9 to 16	V

Operating Characteristics at  $T_a = 25^\circ\text{C}, V_{CC} = 13.2\text{V}, R_L = 4\Omega, f = 1\text{kHz}, R_g = 600\Omega$ , with  $100 \times 100 \times 1.5\text{mm}^3$  Al heat sink, See specified Test Circuit (standby switch ON).

			min	typ	max	unit
Quiescent Current	$I_{CCO}$		40	80	160	mA
Voltage Gain	VG		38	40	42	dB
Output Power	$P_{O1}$	THD=10%	16	20		W
	$P_{O2}$	THD=1%		15		W
Total Harmonic Distortion	THD	$P_o = 1\text{W}$		0.06	0.3	%
Input Resistance	$r_i$		20	30	40	$k\Omega$
Output Noise Voltage	$V_{NO1}$	$R_g = 0, \text{B.P.F.} = 20\text{Hz to } 20\text{kHz}$		90	180	$\mu\text{V}$
	$V_{NO2}$	$R_g = 10k\Omega, \text{B.P.F.} = 20\text{Hz to } 20\text{kHz}$		160	320	$\mu\text{V}$
Output Offset Voltage	$V_{off}$		-300		300	mV
Ripple Rejection	$R_r$	$R_g = 0, V_R = 0\text{dBm}, f_R = 100\text{Hz}$	45	55		dB
Standby Current	$I_{st}$		1.0	100		$\mu\text{A}$

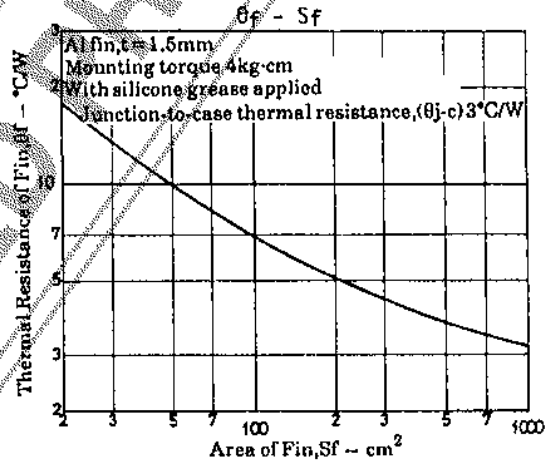
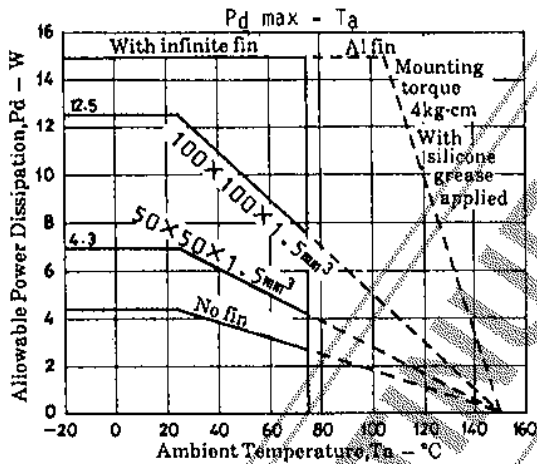

Equivalent Circuit Block Diagram : ( ) is for the LA4496.

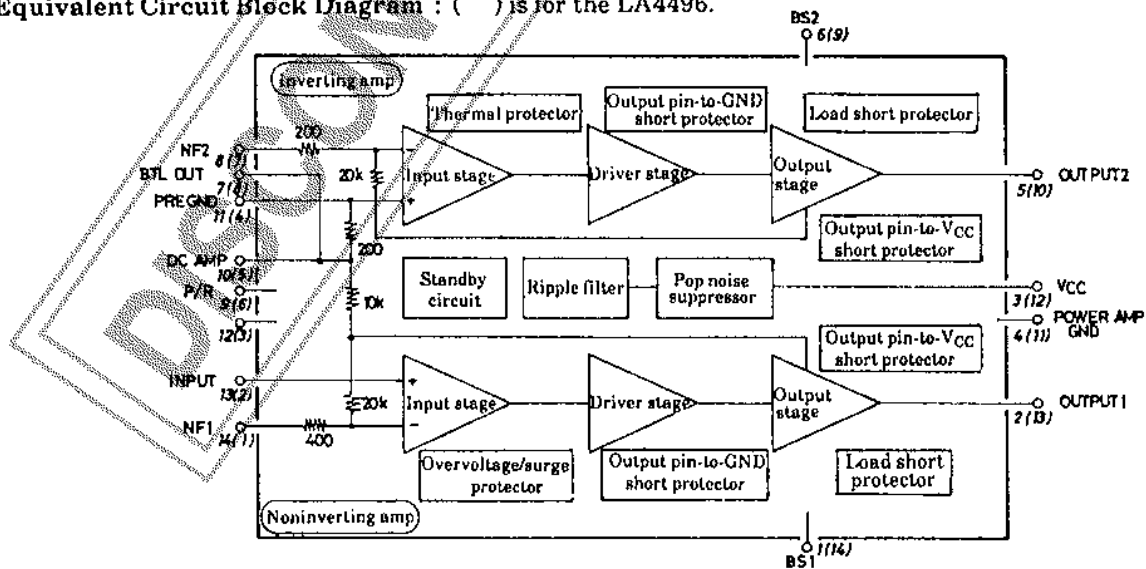

LA4495 No.	①	②	③	④	⑤	⑥	⑦	⑧	⑨	⑩	⑪	⑫	⑬	⑭
LA4496 No.	(14)	(13)	(12)	(11)	(10)	(9)	(8)	(7)	(6)	(5)	(4)	(3)	(2)	(1)
Pin Name	BS 1	OUT 1	VCC	PWR G	OUT 2	BS 2	BYL OUT	NF 2	P/R	DC A	PRE G	DC B	IN	NF 1
Pin Voltage (V)	10.6	6.9	13.2	0	6.9	10.6	0.14	1.25	5.0	12.3	0	1.00	0.614	1.25

Sample Application Circuit

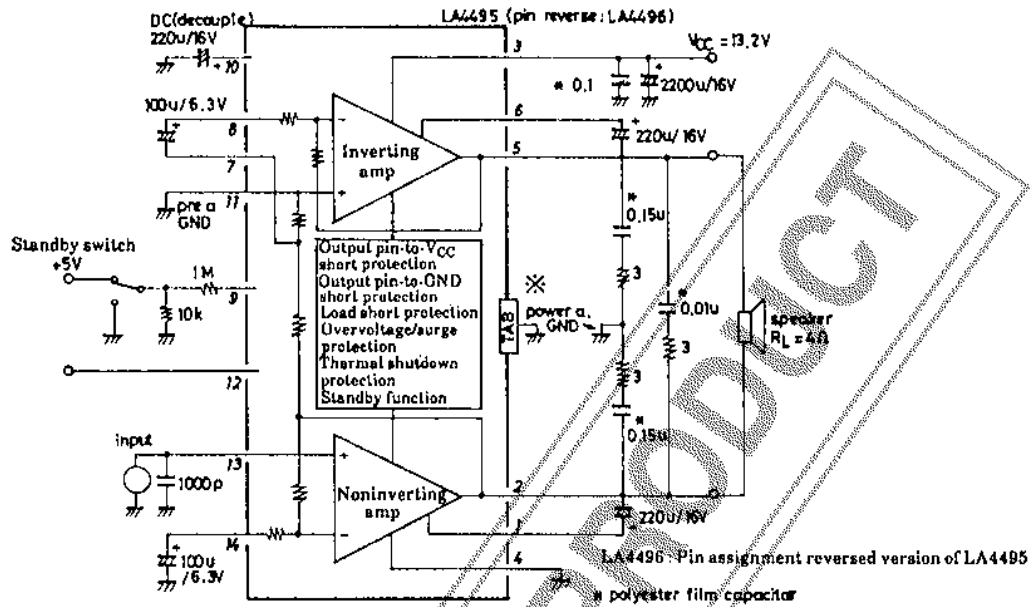

Note: Connect the tab marked \* to large-signal GND.

Note for evaluating a sample IC (how to reduce pop noise when the standby switch is turned OFF)

By changing the value of the bootstrap capacitor from 220μF (now is use) to 47μF and further connecting a filter capacitor of 100μF across pin ④ and GND, pop noise may be reduced when the standby switch is turned OFF.

Sample Printed Circuit Pattern LA4495

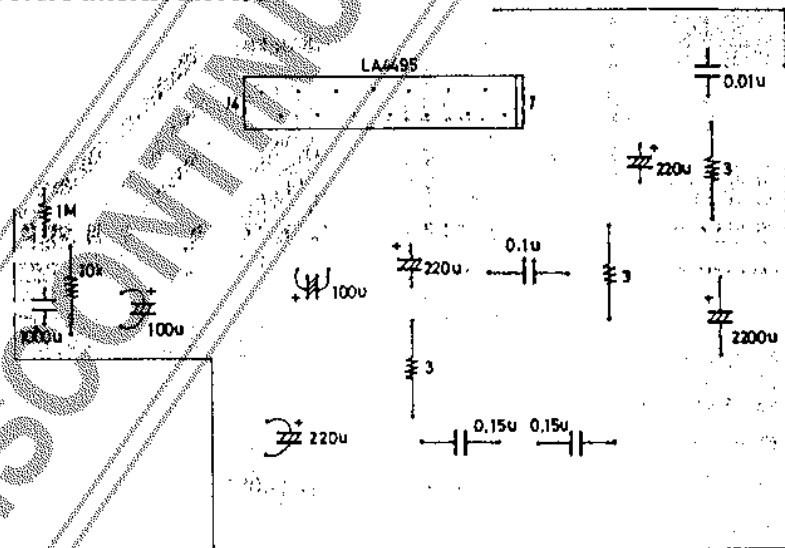

80x60mm<sup>2</sup> (Cu-foiled side)

1. Functions of external parts and proper cares to be taken (explained using pin No. of LA4495)

External parts of the LA4495,4496 are as shown in the Sample Application Circuit. For these external parts, the recommended constants must be used.

The functions of individual external parts, the possibility of reducing them, and the proper cares to be taken in using them are described below.

## a) Feedback capacitors

The capacitor of  $100\mu\text{F}$  connected across pin ⑩ of the noninverting amp and GND and the capacitor of  $100\mu\text{F}$  connected across pin ⑧ and pin ⑦ of the inverting amp are feedback capacitors. It should be noted that it is impossible to remove them and the capacitance value affects the following characteristics.

- Low roll-off frequency  $f_L$
- Pop noise and starting time at the time of application of power

In particular, the effect of the capacitance value on pop noise should be considered. If the capacitance value is decreased,

- Pop noise will strike your ears and the starting time will shorten.

If the capacitance value is increased,

- The starting time will lengthen.

The feedback capacitor value must be in the range of  $47\mu\text{F}$  to  $100\mu\text{F}$ . The feedback capacitors used in the noninverting amp and inverting amp must be the same in the capacitance value and it is best that there is less variation in the capacitance value. This is because transient offset attributable to the imbalance of charging speed is liable to occur at the output terminal.

## b) Filter capacitors

Used mainly for suppressing ripple components on the power line. The capacitor of  $220\mu\text{F}$  externally connected across pin ⑩ and GND is used to prevent ripple components from mixing in. Next, the following should be noted. When the two conditions shown below are set in a car stereo set system :

- The DC (decoupling) capacitor value is increased. (Example : The starting time is made longer.)
- The capacitor of  $220\mu\text{F}$  connected to pin ③ on the power line is discharged abruptly at the time of power OFF.

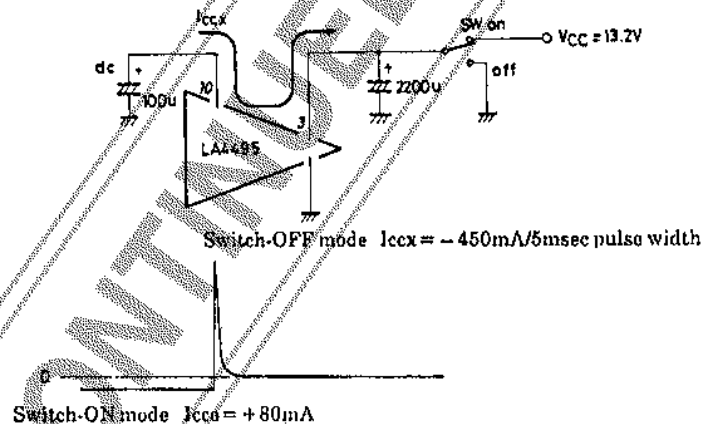

When the potential on pin ③ is decreased abruptly by turning the power switch OFF as shown above, potential reversal between pin ⑩ and pin ③ will occur, causing reverse current  $I_{CCX}$  to flow into the IC system.

This loads the IC heavily.

- When the DC capacitor value is increased, the pulse width of reverse current  $I_{CCX}$  will widen.
- When the supply voltage is raised, reverse current  $I_{CCX}$  will increase.

If this switch-OFF mode is present in the car stereo set system,

- IC handling capability ----- Contact us.
- Measure to be taken externally -- Connect bypass diode DS446 across pin ③ and pin ⑩. (⑩ → ③)

## c) External disturbance preventing capacitor

Capacitor of  $1000\text{pF}$  connected across input pin ③ of the noninverting amp and GND. Whether or not to use this capacitor depends on the design conditions of a car stereo set system. The IC itself does not require this capacitor.

## d) Bootstrap capacitors

Bootstrap capacitors of  $220\mu\text{F}$  are used to provide a full dynamic range at the output terminals. It is impossible to remove these capacitors.

- The bootstrap capacitors affect the drive capability at low frequencies.
- The bootstrap capacitors, which are in the pop noise suppressor channel, affect the starting time.

## e) Oscillation compensation parts

CR filters (oscillation compensation parts) are applied at the output terminals so that feedthrough capacitors (1000 to 2000pF) may be inserted in a car stereo set. If no feedthrough capacitors are required, these CR filters may be simplified (example : all CR filters are removed and a polyester film capacitor of  $0.15\mu\text{F}$  is connected only across pin ② and pin ⑤).

## f) Power capacitor

The capacitance value of  $2200\mu\text{F}$  may be changed according to the design conditions of a car stereo set. The IC itself does not require the polyester film capacitor of  $0.1\mu\text{F}$ . This polyester film capacitor should be inserted when the power line is routed around in a car stereo set and the power impedance viewed from pin ③ rises.

## 2. Features of IC system and proper cares to be taken

## a) Voltage gain VG

The voltage gain inside the IC is designed to be  $VG = 40\text{dB}/\text{typ}$ . This voltage gain may be decreased by external parts, but should be fixed normally to 40dB.

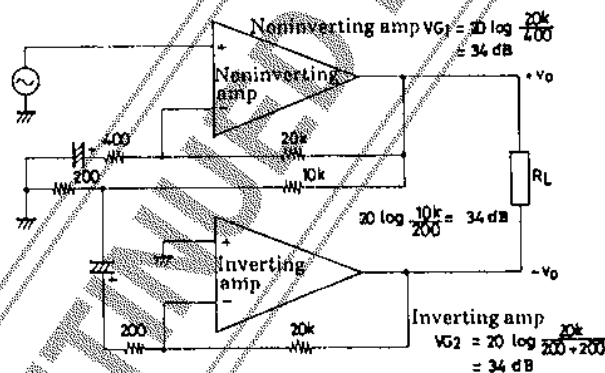

Two output signals of  $+V_o$  and  $-V_o$  are used to obtain  $+V_o - (-V_o) = 2V_o$  at the load terminal.

where  $+V_o$ : Output signal amplified by the noninverting amp ( $VG = 34\text{dB}$ )

$-V_o$ : Inverted output signal obtained by suppressing output signal  $+V_o$  of the noninverting 34dB and applying it to the NF terminal of the inverting amp ( $VG = 34\text{dB}$ )

Therefore,  $34\text{dB} + 6\text{dB} = 40\text{dB}$  is obtained as the VG of a BTL power IC.

This BTL system has the following advantage and disadvantage.

- More advantageous in suppressing noise as compared with an IC containing a phase inverter at the input stage
- The inverting amp is hard to overdrive and the BTL output efficiency is low.

## b) Standby function

The power IC can be turned ON/OFF by applying supply voltage to pin 9. Since the flow-in current (control current) is very low as shown in the characteristic diagram given later, a switch of small current capacity can be used and a microcomputer output can be also used for control. Voltage  $V_{PR}$  to be applied to pin 9 must be 2V or greater, because the threshold is approximately 1V.

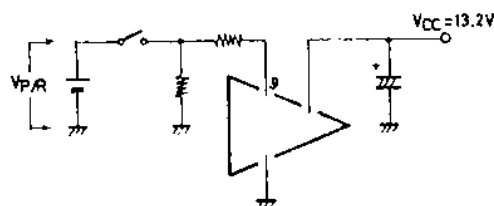

## c) Input zero-bias circuit and slider contact noise of variable resistor

Since the input circuit uses PNP transistors and the bias voltage is set nearly equal to 0, no input coupling capacitor is required, thereby enabling direct connection to the variable resistor.

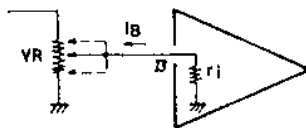

Here, attention should be paid to slider contact noise of the variable resistor. In general, slider contact noise, which also depends on the performance of the variable resistor, becomes higher with increasing input flow-out current  $I_B$  shown above. To prevent slider contact noise from becoming higher, we control the  $V_{13}$  voltage of  $I_B \times r_i$  with pin 13 open ( $V_{13} \text{ max} = 60\text{mV}$ ). If slider contact noise is still offensive to your ears, insert an input coupling capacitor.

## d) Device saturation at the input stage and fold-back waveform

When  $\text{THD} \geq 20\%$ , a part of the clip waveform at the output terminal will be folded back. The reason why this phenomenon occurs is that the dynamic range of the zero-bias circuit at the input stage is narrow and the device is saturated. The level diagram of the car stereo set must be considered and a measure must be taken to prevent a high input level from being applied to the input terminal (if the input level is made high and the output fold-back waveform becomes sharp, blocking symptoms may be developed). In this case, it is better to connect the tab (heat sink) to large-signal GND (it is also better to insert an input coupling capacitor).

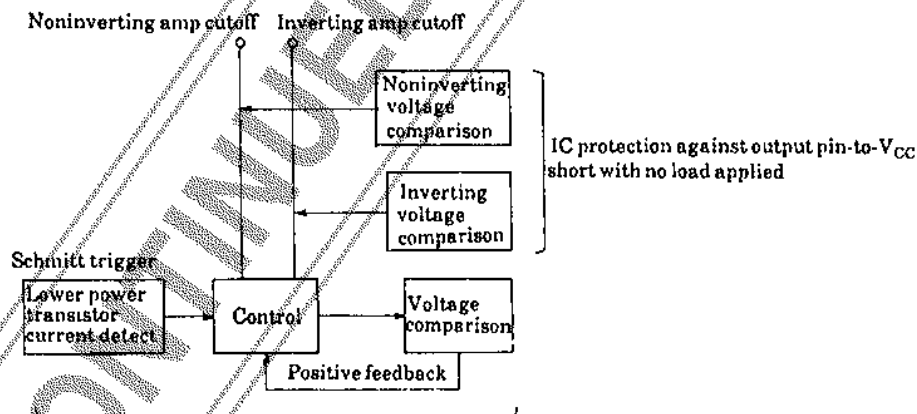
e) Output pin-to- $V_{CC}$  short protector

Speaker protection, IC protection against output pin-to- $V_{CC}$  short with load applied

In general, if output pin-to- $V_{CC}$  short occurs in an IC with no protector provided, DC feedback provided inside the IC may cause lower power transistors in both of noninverting amp, inverting amp to be subjected to ASO breakdown in a moment and may also cause the speaker to be damaged. Therefore, it is absolutely necessary for BTCL high-power ICs to contain an output pin-to- $V_{CC}$  short protector. The LA4495,4496 contain the output pin-to- $V_{CC}$  short protector of the above-mentioned block diagram that provides IC protection, speaker protection. Output pin-to- $V_{CC}$  short is classified into two cases - after output pin-to- $V_{CC}$  short  $\rightarrow$  application of power and after application of power  $\rightarrow$  output pin-to- $V_{CC}$  short. It is assumed that the former is the trouble caused by the end user and the latter is the trouble caused by the manufacturing process (we have developed the LA4495,4496 with the former in mind). When we designed the protector that should operate normally in these two cases, it was difficult for us to suppress the side effect - especially pop noise, but we succeeded in solving this problem. The following are the points that we considered in designing the output pin-to- $V_{CC}$  short protector and the problem that is yet to be solved.

- The output pin of the noninverting amp and the output pin of the inverting amp are shorted to  $V_{CC}$  separately.
- The output pin of the noninverting amp and the output pin of the inverting amp are shorted to  $V_{CC}$  simultaneously.
- Output pin-to- $V_{CC}$  short with load/with no load
- Output pin-to- $V_{CC}$  short with signal/with no signal

- Application of power after output pin-to- $V_{CC}$  short
- Output pin-to- $V_{CC}$  short after application of power
- Impedance of output pin-to- $V_{CC}$  short :  $0.3\Omega$  is obtained.
- Protection of both IC and speaker

#### Problem to be solved

- If next output pin-to- $V_{CC}$  short occurs before the IC returns to the normal bias state (within 200msec.) after output pin-to- $V_{CC}$  short is opened, nonoperation of the IC is liable to occur (repetition test of output pin-to- $V_{CC}$  short). However, repetition of power ON/OFF at the output pin-to- $V_{CC}$  short mode presents no problem.

#### f) Output pin-to-GND short protector

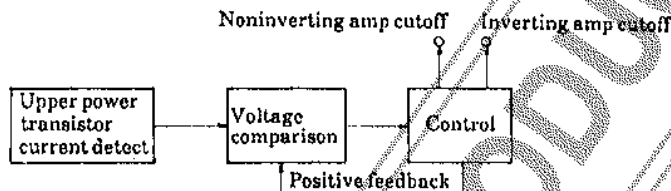

The LA4495,4496 contain the output pin-to-GND short protector of the above-mentioned block diagram that provides IC protection, speaker protection. Output pin-to-GND short is also classified into two cases - after output pin-to-GND short  $\rightarrow$  application of power and after application of power  $\rightarrow$  output pin-to-GND short. It is assumed that the former is the trouble caused by the end user and the latter is the trouble caused by the manufacturing process (as with output pin-to- $V_{CC}$  short, we have developed the LA4495,4496 with the former in mind). When we designed the protector that should operate normally in these two cases, it was difficult for us to suppress the side effect - especially pop noise, but we succeeded in solving this problem. The following are the points that we considered in designing the output pin-to-GND short protector and the problems that are yet to be solved.

- The output pin of the noninverting amp and the output pin of the inverting amp are shorted to GND separately.
- The output pin of the noninverting amp and the output pin of the inverting amp are shorted to GND simultaneously.
- Output pin-to-GND short with load/with no load
- Output pin-to-GND short with signal/with no signal
- Application of power after output pin-to-GND short
- Output pin-to-GND short after application of power
- Impedance of output pin-to-GND short :  $0.3\Omega$  is obtained.
- Protection of both IC and speaker

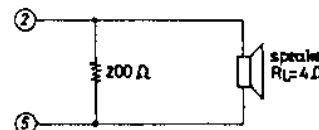

#### Problems to be solved

- When power is applied after output pin-to-GND short with no load, nonoperation of the IC is liable to occur. A resistor of approximately  $200\Omega$  must be connected across output pins.
- If next output pin-to-GND short occurs before the IC returns to the normal bias state (within 200msec.) after output pin-to-GND short is opened, nonoperation of the IC is liable to occur (repetition test of output pin-to-GND short). However, repetition of power ON/OFF at the output pin-to-GND short mode presents no problem if the resistor of  $200\Omega$  is connected as shown above.
- The supply voltage range of a car stereo set is 10.5 to 15.6V. If 10V or less at the output pin-to-GND short mode after application of power, nonoperation of the IC will be liable to occur.
- Measure against nonoperation caused by repetition of output pin-to-GND short (When two LA4490s or LA4495s are used)
- If repetition of output pin-to-GND short causes nonoperation to occur, connect the external parts as shown below.

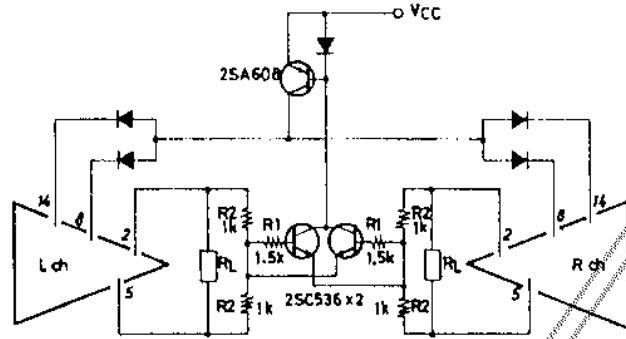

Note) If the output pins of both Lch and Rch are shorted to GND simultaneously, this measure is not available.

g)  $R_L$  short

When the load is shorted, current detection of the upper/lower power transistors in the output pin-to- $V_{CC}$  short protector and output pin-to-GND short protector occurs alternately, the voltage across pins 2, 5 and GND and the current at pins 2, 5, which depend on the signal level, will fluctuate. The protection function works within the ASO of the device. When performing the load short test, a heat sink must be attached and a choke must be connected to the power line. The main purpose of the thermal shutdown protection is to suppress  $T_j$  rise which may be caused by improper thermal design.  $T_j$  is set to  $170^\circ\text{C}$ . The thermal shutdown protection is not intended to suppress transient temperature rise caused by current pulse as shown in the above-mentioned load short case.

h) Proper cares to be taken

- If the IC is operated at  $T_j \geq 150^\circ\text{C}$ , the clip waveform is liable to be distorted, which may lower the tone quality. Be careful of thermal design.
- When  $T_j \geq 150^\circ\text{C}$ , the ASO of the power transistor device becomes narrower and the protection function does not work well. When subjecting the IC to the following tests under this thermal condition, the IC is once locked and returns to normal automatically when  $T_j \geq 150^\circ\text{C}$  (output pin-to- $V_{CC}$  short, output pin-to-GND short,  $R_L$  short).
- If output pin-to- $V_{CC}$  short and output pin-to-GND short occur simultaneously, the IC will be broken down. This case occurs when the noninverting amp output pin is connected to  $V_{CC}$  and the inverting amp output pin is connected to GND simultaneously.
- 3-wire common connection  
Wrong connection where one of Lch output terminals and one of Rch output terminals are connected as common. If a choke is connected to the power line, no instantaneous breakdown will occur and sound will not continue to be produced unlike ICs heretofore in use and blocking symptoms will be developed. This phenomenon makes the wrong connection known to the end user.
- Connection of  $V_{CC}$  pin to GND and connection of GND pin to  $V_{CC}$   
Instantaneous breakdown may occur.

Main SW ON/OFF Characteristic of Typical Circuit ( $V_{CC} = 13.2\text{V}$ ,  $R_L = 4\Omega$ ,  $R_g = 600\Omega$ )

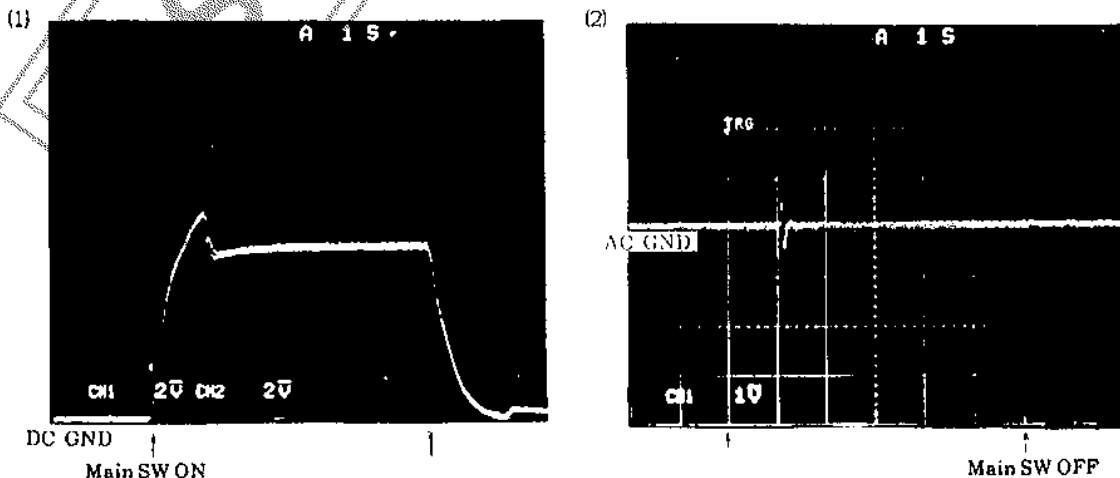



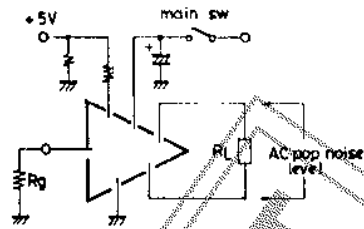
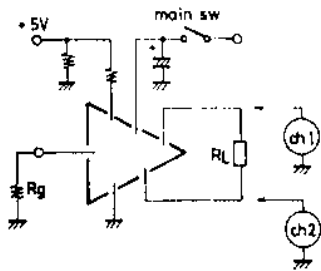

Pop noise of approximately 1Vp-p is generated at the starting point ( $t_s=1.2\text{sec}$ ) after main SW is turned ON. However, the tone quality is not affected very much because the pulse width is 200msec to 300msec. There arises no problem when power is turned OFF.

( $V_{CC}=13.2\text{V}, R_L=4\Omega, f=1\text{kHz}, R_g=600\Omega, P_o=1\text{W}$ )

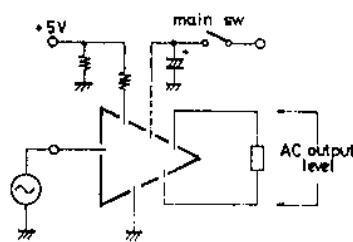
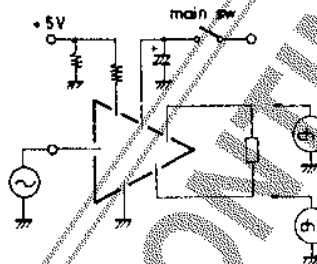
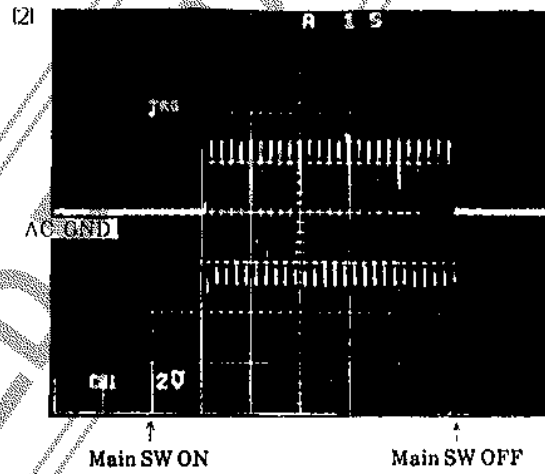
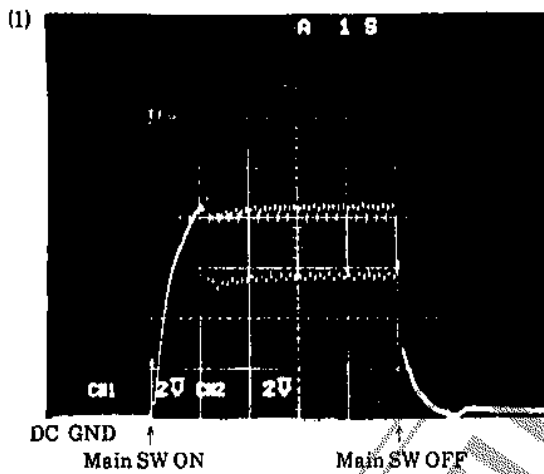

Standby SW ON/OFF Characteristic of Typical Circuit ( $V_{CC}=13.2\text{V}, R_L=4\Omega, R_g=600\Omega$ )

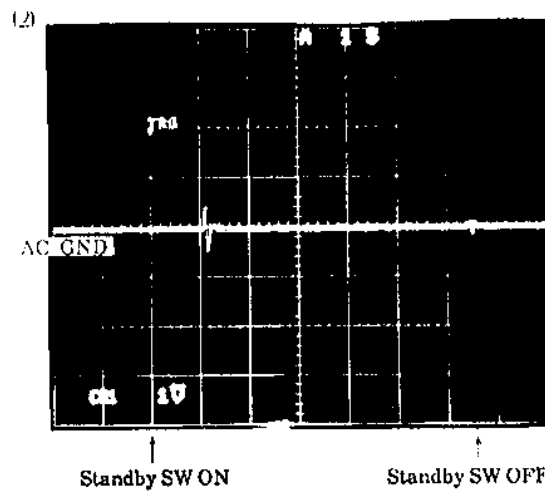
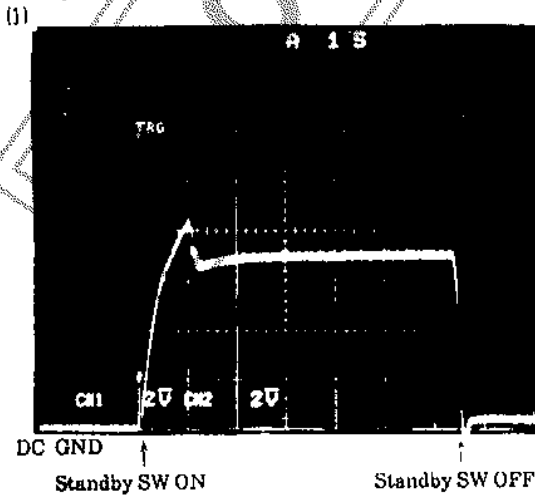

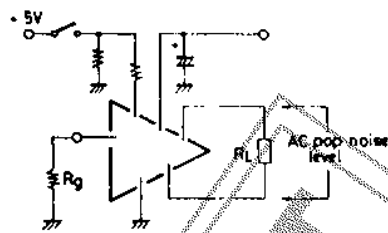
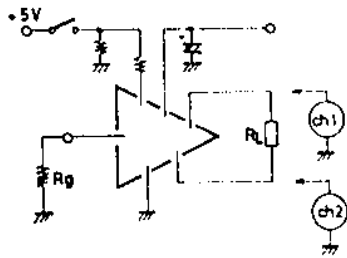

Pop noise of approximately 1Vp-p is generated at the starting point ( $t_s = 1.2\text{sec}$ ) after main SW is turned ON. However, the tone quality is not affected very much because the pulse width is 200msec to 300msec. There arises no problem when power is turned OFF.

( $V_{CC} = 13.2\text{V}$ ,  $R_L = 4\Omega$ ,  $f = 1\text{kHz}$ ,  $R_g = 600\Omega$ ,  $P_o = 1\text{W}$ )

(1)

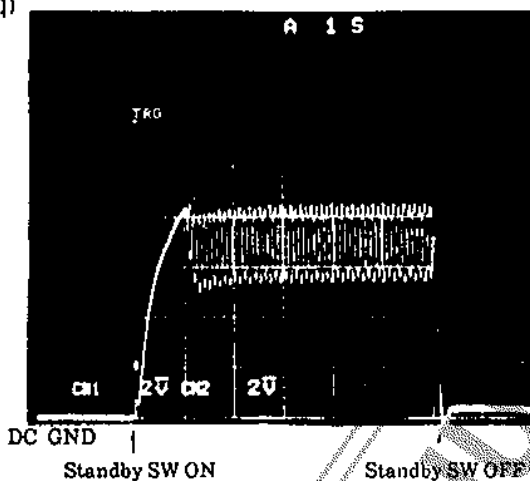

(2)

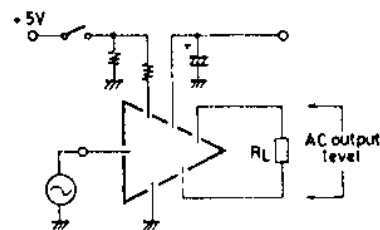
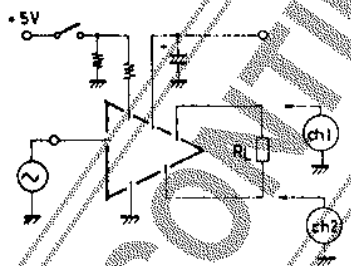
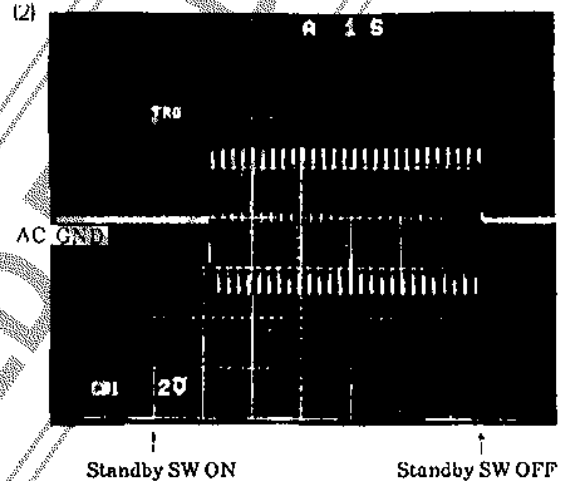

### Proper Cares in Using IC

#### • Maximum ratings

It should be noted that if the IC is used in the vicinity of the maximum ratings, even a slight variation in conditions may cause the maximum ratings to be exceeded, thereby leading to breakdown.

#### • Printed circuit board

When making the board, refer to the sample printed circuit pattern and be careful that no feedback loop is formed between input and output.

#### • Other

OCL power IC having BTL connection internally. Be careful that the GND line of the measuring instruments (valve voltmeter, distortion meter, oscilloscope) connected to the output terminals is not shared with the GND line of the measuring instruments connected to the input and output terminals.

