

## Features

- Single Control CMOS Logic for Each Bit
- Attenuation: 1 dB Steps to 15 dB
- Low DC Power Consumption: 50  $\mu$ W
- Lead-Free TSSOP-16 Package
- 100% Matte Tin Plating over Copper
- Halogen-Free "Green" Mold Compound
- RoHS\* Compliant and 260°C Reflow Compatible

## Description

The M/A-COM MAATSS0019 is a 4 Bit, 1 dB step GaAs MMIC digital attenuator in a lead-free TSSOP-16 surface mount plastic package. The MAATSS0019 is ideally suited for use where high accuracy, very low power consumption and low intermodulation products are required. Typical applications include radio, cellular, wireless LANs, GPS equipment and other gain / level control circuits.

The MAATSS0019 is fabricated using a mature 1 micron GaAs MESFET process. The process features full chip passivation for increased performance and reliability.

## Functional Schematic <sup>3,4</sup>

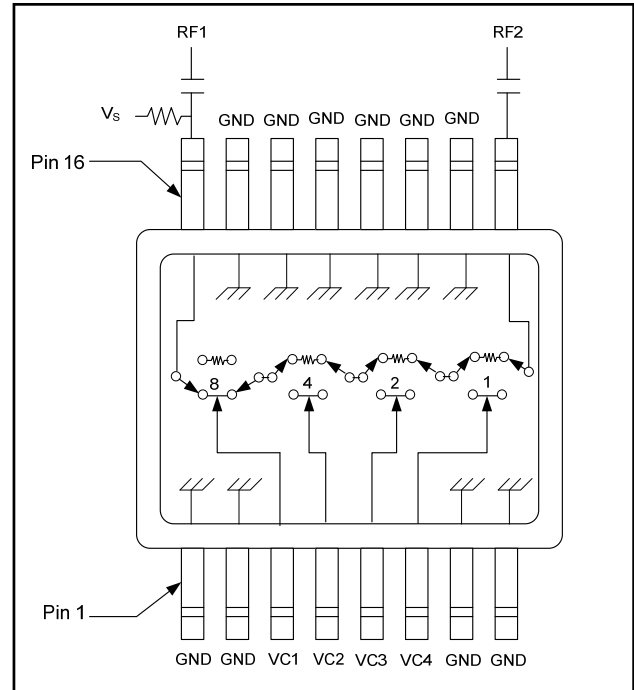

3. Required external blocking caps shown.
4. VS can be applied at RF1 or RF2 using a 10K  $\Omega$  or greater pull-up resistor.

## Ordering Information <sup>1,2</sup>

| Part Number   | Package         |
|---------------|-----------------|
| MAATSS0019    | Bulk Packaging  |
| MAATSS0019TR  | 1000 piece reel |
| MAATSS0019SMB | Sample Board    |

1. Reference Application Note M513 for reel size information.
2. All sample boards include 5 loose parts.

## Pin Configuration

| Pin No. | Function | Pin No. | Function  |
|---------|----------|---------|-----------|
| 1       | Ground   | 9       | RF Port 2 |
| 2       | Ground   | 10      | Ground    |
| 3       | VC1      | 11      | Ground    |
| 4       | VC2      | 12      | Ground    |
| 5       | VC3      | 13      | Ground    |
| 6       | VC4      | 14      | Ground    |
| 7       | Ground   | 15      | Ground    |
| 8       | Ground   | 16      | RF Port 1 |

\* Restrictions on Hazardous Substances, European Union Directive 2002/95/EC.

## Electrical Specifications: $T_A = 25^\circ\text{C}$

| Parameter                | Test Conditions   | Units  | Min.   | Typ.           | Max.   |
|--------------------------|---|--|--------|----------------|--------|
| Reference Insertion Loss | 0.5 - 1.0 GHz   | dB   | —      | 1.3            | 1.6    |
|                          | 1.0 - 2.0 GHz   | dB   | —      | 1.6            | —      |
|                          | 2.0 - 3.0 GHz   | dB   | —      | 1.8            | —      |
|                          | 3.0 - 4.0 GHz   | dB   | —      | 2.5            | —      |
| Attenuation Accuracy     | 0.5 - 1.0 GHz<br>1.0 - 2.0 GHz<br>2.0 - 4.0 GHz                                       | $\pm (0.25 \text{ dB} + 5\% \text{ of Atten. setting in dB}) \text{ dB}$<br>$\pm (0.4 \text{ dB} + 5\% \text{ of Atten. setting in dB}) \text{ dB Typical}$<br>$\pm (0.6 \text{ dB} + 5\% \text{ of Atten. setting in dB}) \text{ dB Typical}$ |        |                |        |
| VSWR                     | 0.5 - 2.0 GHz<br>2.0 - 4.0 GHz  | Ratio<br>Ratio   | —<br>— | 1.3:1<br>1.3:1 | —<br>— |
| Trise, Tfall             | —   | $\mu\text{S}$  | —      | 2.5            | —      |
| Ton, Toff                | —   | $\mu\text{S}$  | —      | 1.0            | —      |
| Input P1dB               | > 0.5 GHz   | dBm  | —      | 24             | —      |
| IP <sub>2</sub>          | Measured Relative to Input Power, Two Tone input up to 5 dBm, 5 MHz Spacing > 0.5 GHz | dBm  | —      | 80             | —      |
| IP <sub>3</sub>          | Measured Relative to Input Power, Two Tone input up to 5 dBm, 5 MHz Spacing > 0.5 GHz | dBm  | —      | 47             | —      |

## Absolute Maximum Ratings <sup>5,6</sup>

| Parameter                               | Absolute Maximum   |
|---|--------------------|
| Input Power<br>50 MHz<br>500 - 4000 MHz | +27 dBm<br>+34 dBm |
| Control Voltage                         | +8 V, -1.0 V       |
| Operating Temperature                   | -40°C to +85°C     |
| Storage Temperature                     | -65°C to +150°C    |

- Exceeding any one or combination of these limits may cause permanent damage to this device.
- M/A-COM does not recommend sustained operation near these survivability limits.

## Truth Table <sup>7,8</sup>

| VC1 | VC2 | VC3 | VC4 | Attenuation (dB) |
|-----|-----|-----|-----|------------------|
| 1   | 1   | 1   | 1   | Reference IL     |
| 1   | 1   | 1   | 0   | 1                |
| 1   | 1   | 0   | 1   | 2                |
| 1   | 0   | 1   | 1   | 4                |
| 0   | 1   | 1   | 1   | 8                |
| 0   | 0   | 0   | 0   | 15               |

- 0 =  $0 \pm 0.2 \text{ V}$ , 1 = +5 V @ 50  $\mu\text{A}$  max. current total.
- VS = +5 V.

## Handling Procedures

Please observe the following precautions to avoid damage:

## Static Sensitivity

Gallium Arsenide Integrated Circuits are sensitive to electrostatic discharge (ESD) and can be damaged by static electricity. Proper ESD control techniques should be used when handling these devices.

## Typical Performance Curves

**Relative Attenuation**

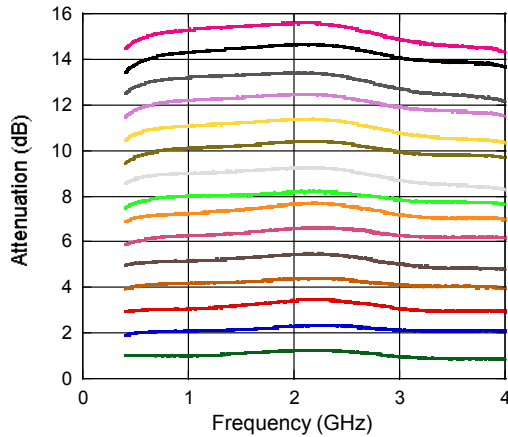

**Insertion Loss**

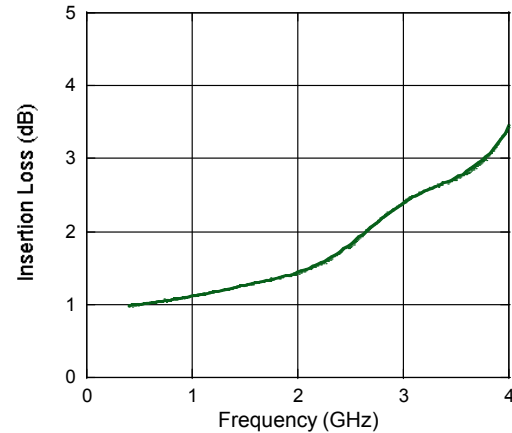

**Input Return Loss**

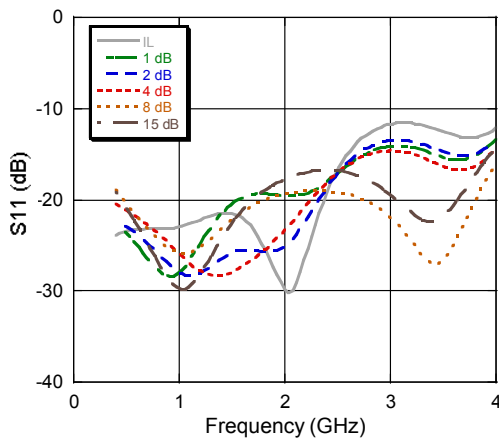

**Output Return Loss**

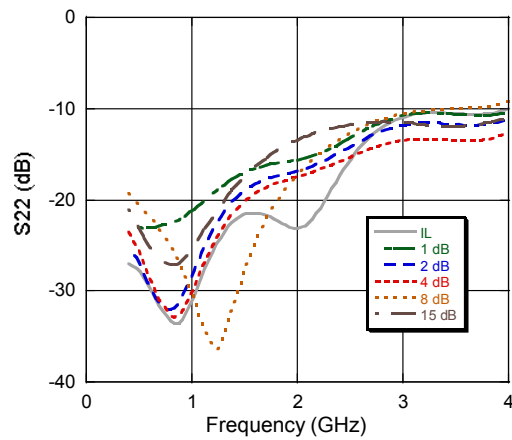

**Attenuation Accuracy**

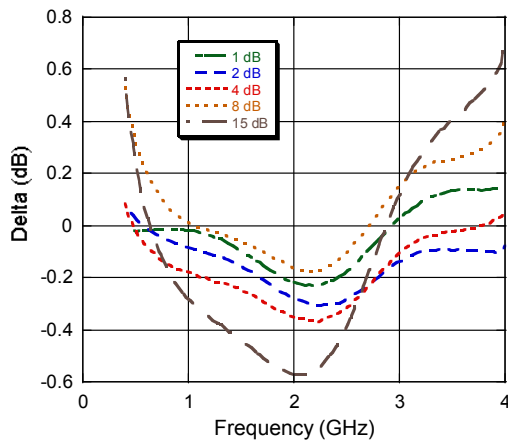

**Input IP3**

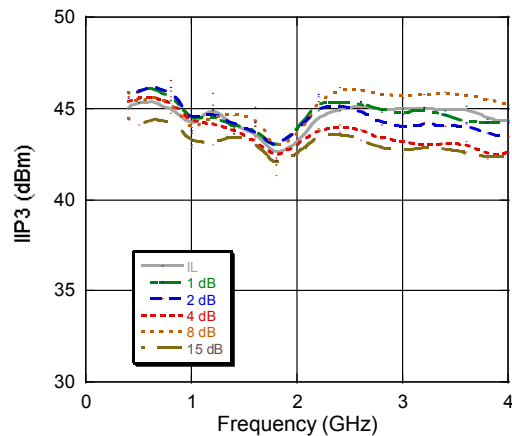

## Lead Free TSSOP-16<sup>†</sup>

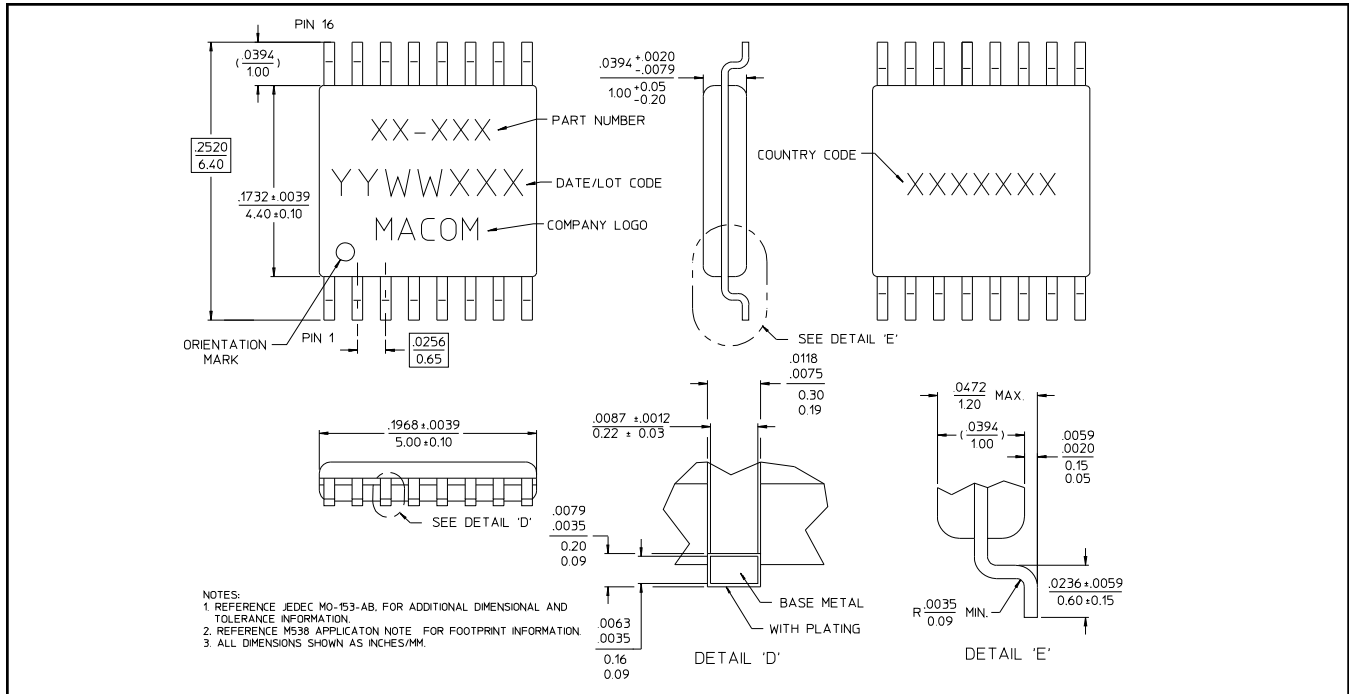

<sup>†</sup> Reference Application Note M538 for lead-free solder reflow recommendations.  
 Meets JEDEC moisture sensitivity level 1 requirements.