

Digital Attenuator
30.0 dB, 4-Bit, TTL Driver, DC-3.0 GHz

MAATCC0006
V3

Features

- Attenuation: 2.0 dB steps to 30 dB
- Low DC Power Consumption
- Integral TTL Driver
- 50 Ohm Impedance
- Temperature Stability: ± 0.18 dB from -55°C to $+85^{\circ}\text{C}$ Typ.
- Lead-Free SO-16 Package
- 100% Matte Tin Plating over Copper
- Halogen-Free "Green" Mold Compound
- 260°C Reflow Compatible
- RoHS* Compliant Version of AT65-0233

Description

M/A-COM's MAATCC0006 is a GaAs FET 4-bit digital attenuator with a 2.0 dB minimum step size and a 30 dB total attenuation range. This device is in a SOIC-16 plastic surface mount package. The MAATCC0006 is ideally suited for use where accuracy, fast speed, very low power consumption and low costs are required. Typical applications include dynamic range setting in precision receiver circuits and other gain/leveling control circuits.

Schematic with Off-Chip Components or Functional Block Diagram

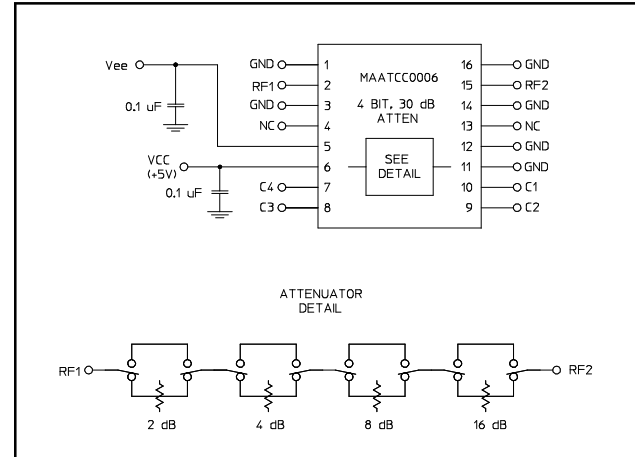

Ordering Information

Part Number	Package
MAATCC0006	Bulk Packaging
MAATCC0006TR	1000 piece reel
MAATCC0006-TB	Sample Test Board

Note: Reference Application Note M513 for reel size information.

Note: Die quantity varies.

Pin Configuration

Pin No.	Function	Pin No.	Function
1	GND	9	C2
2	RF1	10	C1
3	GND	11	GND
4	NC ¹	12	GND
5	Vee	13	NC ¹
6	Vcc	14	GND
7	C4	15	RF2
8	C3	16	GND

1. NC = No Connection

* Restrictions on Hazardous Substances, European Union Directive 2002/95/EC.

**Digital Attenuator
30.0 dB, 4-Bit, TTL Driver, DC-3.0 GHz**

**MAATCC0006
V3**

Electrical Specifications: T_A = 25°C

Parameter	Test Conditions	Frequency	Units	Min	Typ	Max
Insertion Loss	—	DC - 0.5 GHz	dB	—	1.7	2.0
		DC - 2.0 GHz	dB	—	2.3	2.7
		DC - 3.0 GHz	dB	—	2.6	3.1
Attenuation Accuracy	Any Bit or Combination of Bits	DC - 3.0 GHz	dB	± (.4 + 8% of attenuation)	± (.4 + 8% of attenuation)	± (.4 + 8% of attenuation)
VSWR	Full Range	DC - 3.0 GHz	Ratio	—	—	1.7:1
Trise, Tfall Ton, Toff Transients	10% to 90% 50% Cntl to 90%/10% RF In-Band	10% to 90%	nS	—	10	50
		50% Cntl to 90%/10% RF In-Band	nS	—	30	150
		90%/10% RF In-Band	mV	—	35	—
1 dB Compression	Input Power Input Power	0.05 GHz	dBm	—	+20	—
		0.5 - 3.0 GHz	dBm	—	+28	—
Input IP ₃	Two-tone inputs up to +5 dBm	0.05 GHz 0.5 - 3.0 GHz	dBm dBm	— —	+40 +50	— —
Input IP ₂	Two-tone inputs up to +5 dBm	0.05 GHz 0.5 - 3.0 GHz	dBm dBm	— —	+45 +68	— —
V _{CC} V _{EE}	— —	— —	V V	4.5 -8.0	5.0 -5.0	5.5 -4.75
V _{IL} V _{IH}	LOW-level input voltage HIGH-level input voltage	— —	V V	0.0 2.0	— —	0.8 5.0
I _{in} (Input Leakage Current)	V _{in} = V _{CC} or GND	—	uA	-1.0	—	1.0
I _{cc} (Quiescent Supply Current)	V _{cntrl} = V _{CC} or GND	—	uA	—	250	400
ΔI _{cc} (Additional Supply Current Per TTL Input Pin)	V _{CC} = Max, V _{cntrl} = V _{CC} - 2.1 V	—	mA	—	—	1.0
I _{EE}	V _{EE} min to max, V _{in} = V _{IL} or V _{IH}	—	mA	-1.0	-0.2	—

Absolute Maximum Ratings^{2,3}

Parameter	Absolute Maximum
Max. Input Power 0.05 GHz 0.5 - 3.0 GHz	+27 dBm +34 dBm
V _{CC}	-0.5V ≤ V _{CC} ≤ +7.0V
V _{EE}	-8.5V ≤ V _{EE} ≤ +0.5V
V _{CC} - V _{EE}	-0.5V ≤ V _{CC} - V _{EE} ≤ 14.5V
V _{in} ⁴	-0.5V ≤ V _{in} ≤ V _{CC} + 0.5V
Operating Temperature	-40°C to +85°C
Storage Temperature	-65°C to +125°C

- Exceeding any one or combination of these limits may cause permanent damage to this device.
- M/A-COM does not recommend sustained operation near these survivability limits.
- Standard CMOS TTL interface, latch=up will occur if logic signal applied prior to power supply.

2

M/A-COM Inc. and its affiliates reserve the right to make changes to the product(s) or information contained herein without notice. M/A-COM makes no warranty, representation or guarantee regarding the suitability of its products for any particular purpose, nor does M/A-COM assume any liability whatsoever arising out of the use or application of any product(s) or information.

- **North America** Tel: 800.366.2266 / Fax: 978.366.2266
- **Europe** Tel: 44.1908.574.200 / Fax: 44.1908.574.300
- **Asia/Pacific** Tel: 81.44.844.8296 / Fax: 81.44.844.8298

Visit www.macom.com for additional data sheets and product information.

Digital Attenuator
30.0 dB, 4-Bit, TTL Driver, DC-3.0 GHz

MAATCC0006
V3

Handling Procedures

Please observe the following precautions to avoid damage:

Static Sensitivity

Gallium Arsenide Integrated Circuits are sensitive to electrostatic discharge (ESD) and can be damaged by static electricity. Proper ESD control techniques should be used when handling these devices.

Truth Table (Digital Attenuator)

C1	C2	C3	C4	Attenuation
0	0	0	0	Loss, Reference
1	0	0	0	2.0 dB
0	1	0	0	4.0 dB
0	0	1	0	8.0 dB
0	0	0	1	16.0 dB
1	1	1	1	30.0 dB

0 = TTL Low; 1 = TTL High

Typical Performance Curves

Typical Insertion Loss (dB)

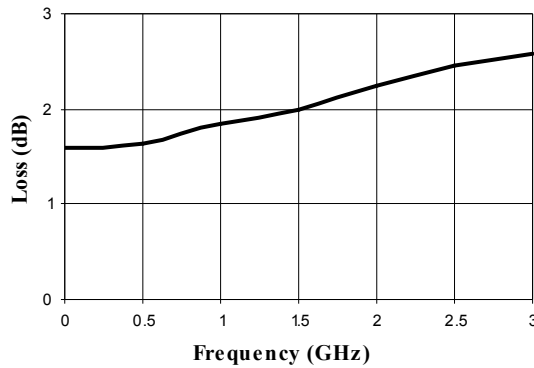

Attenuation Accuracy, 2 dB

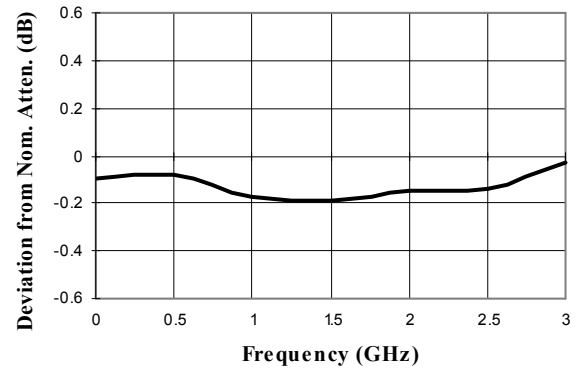

Attenuation Accuracy, 4 dB

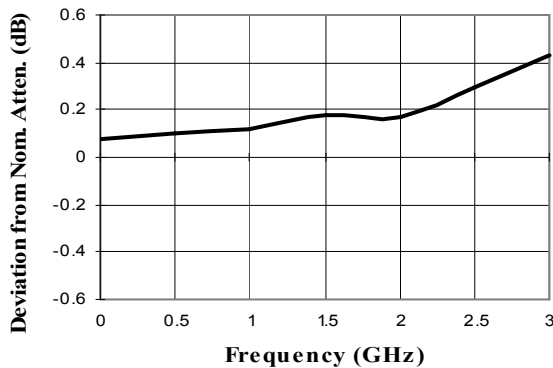

Attenuation Accuracy, 8 dB

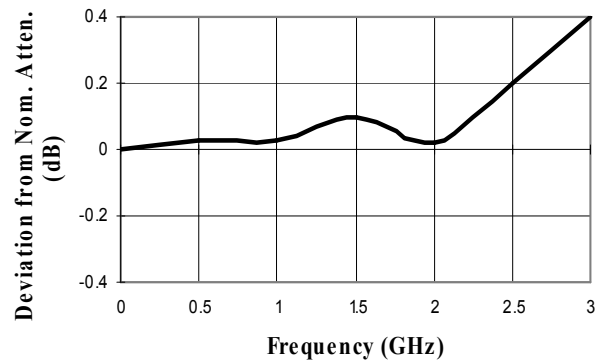

**Digital Attenuator
30.0 dB, 4-Bit, TTL Driver, DC-3.0 GHz**

**MAATCC0006
V3**

Typical Performance Curves

Attenuation Accuracy, 16 dB

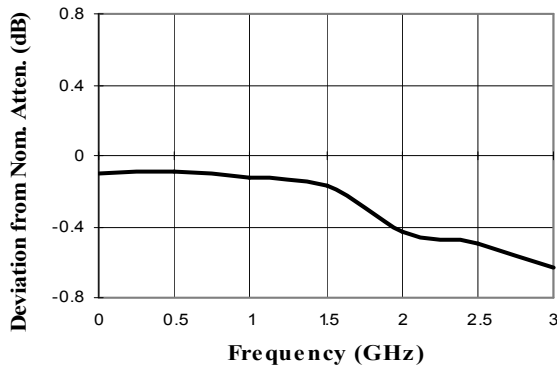

Attenuation Accuracy, 30 dB

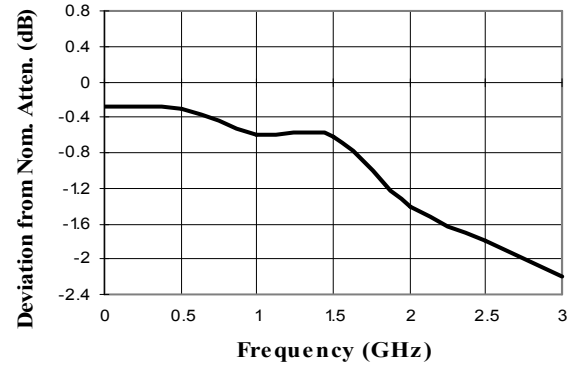

Typical RF1 VSWR

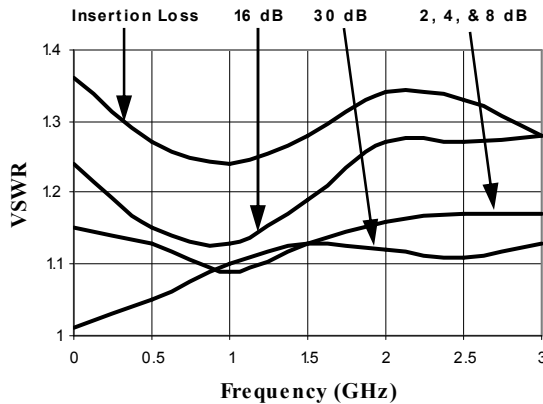

Typical RF2 VSWR

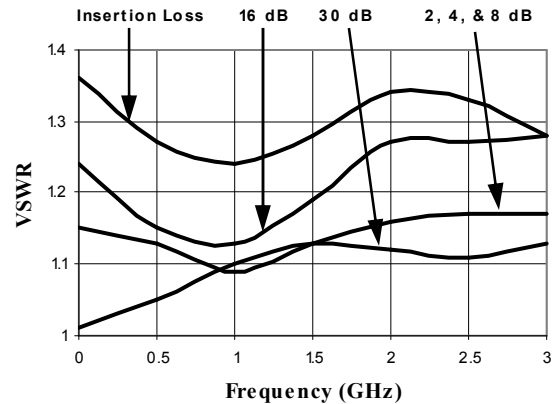

**Digital Attenuator
30.0 dB, 4-Bit, TTL Driver, DC-3.0 GHz**

**MAATCC0006
V3**

Lead-Free, SO-16†

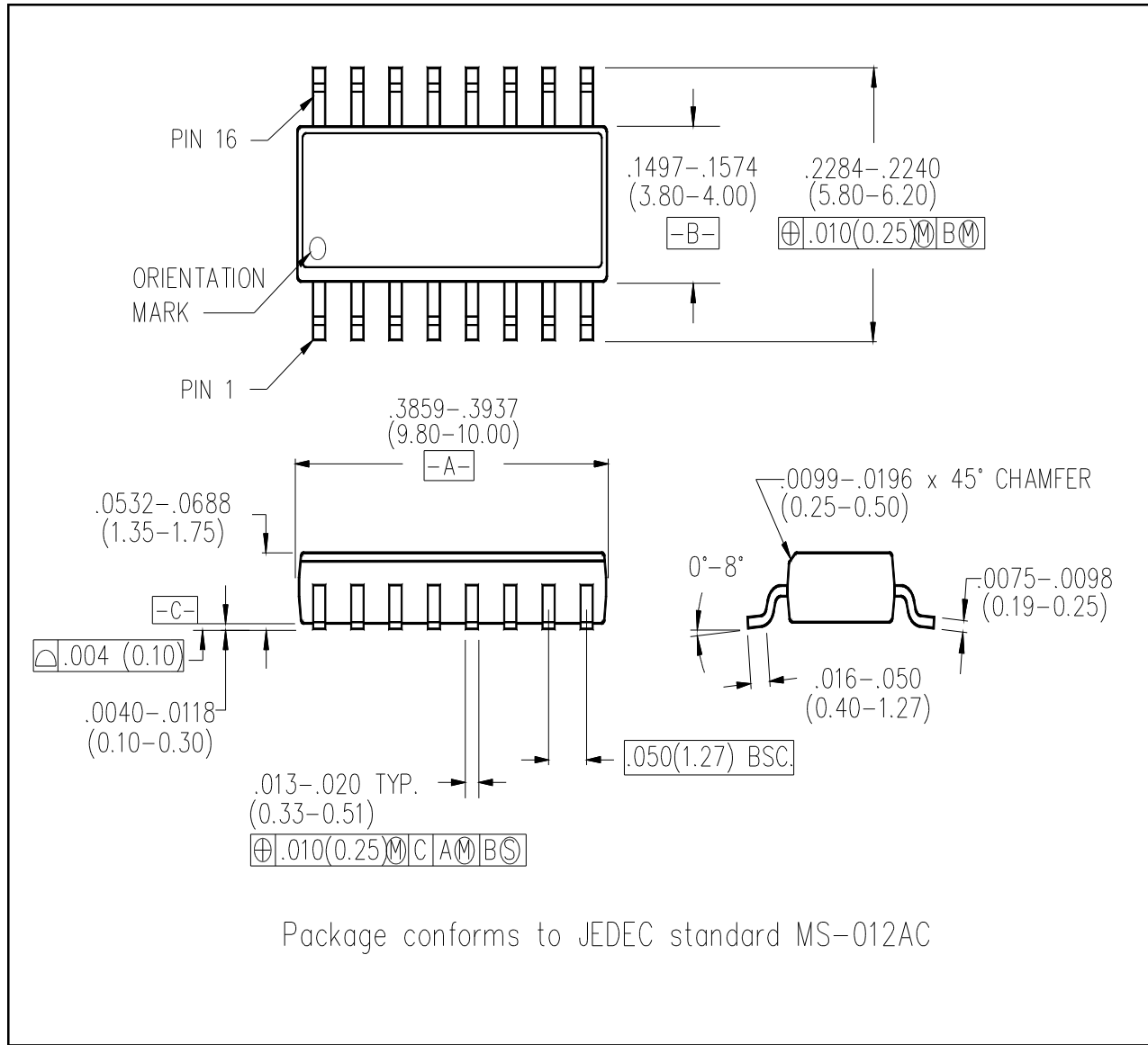

† Reference Application Note M538 for lead-free solder reflow recommendations.