

Model name

EWS 15-5

Name of series Output power

Features

- CE marking (Low Voltage Directive)
- 74 models, 15 ~ 1500W
- Wide input voltage range
EWS15, 25, 50: 85 ~ 265VAC universal input
EWS100, 150, 300, 600: 100/200VAC auto-selectable
EWS1500: 100/200VAC user-selectable
- Wide output voltage range: ±20% (EWS300, 600, 1500)
- Output voltage programmable (EWS1500):
0V to nominal output voltage by external control
- 3 year warranty

Specifications

1. Input voltage range	EWS15, 25, 50: 85 ~ 265VAC (47 ~ 440Hz), DC110 ~ 330V universal input EWS100, 150, 300, 600: 85 ~ 132VAC/170 ~ 265VAC (47 ~ 63Hz) auto-selectable EWS1500: 85 ~ 132VAC/170 ~ 265VAC (47 ~ 63Hz) user-selectable
2. Output voltage range	EWS15, 25, 50, 100, 150: ±10% EWS300, 600, 1500: ±20% (2V: -10 ~ +20%) EWS1500: ±20% or 0V to nominal output voltage × 120% by external control
3. Cooling	EWS15, 25, 50, 100, 150: Convection cooling, EWS300, 600, 1500: Forced air cooling by internal fan
4. Operating ambient temperature (Standard mounting)	-10 ~ +60°C (Output derating) EWS15, 25, 50/-10°C: 70%, 0 ~ +50°C: 100%, +60°C: 50% EWS100,150/-10°C: 72%, 0 ~ +40°C: 120%, +50°C: 100%, +60°C: 48% EWS300, 600, 1500/-10°C: 70%, 0 ~ +50°C: 100%, +60°C: 70%
5. Withstand voltage	Input-output: 3.75kVAC, Input-FG: 2.5kVAC, Output-FG: 500VAC for 1 min.
6. Safety standard	Approved by UL1950 , CSA950 (EWS300: approved by CSA234) and EN60950
7. EMI	Conforms to VCCI-class A and FCC class A
8. Functions	Over voltage protection, Over current protection, Remote sensing (EWS100 ~ 1500), Remote on/off control (EWS300 ~ 1500), Output current balancing (EWS300 ~ 1500)

Product lineup

Model name	Nominal output voltage	Max. output current	Max. output power	UL	CSA	EN	
EWS15	EWS15-5	5V	3.0A	15W	○	○	○
	EWS15-6	6V	2.5A	15W	○	○	○
	EWS15-9	9V	1.7A	15.3W	○	○	○
	EWS15-12	12V	1.4A	16.8W	○	○	○
	EWS15-15	15V	1.1A	16.5W	○	○	○
	EWS15-18	18V	0.9A	16.2W	○	○	○
	EWS15-24	24V	0.7A	16.8W	○	○	○
	EWS15-28	28V	0.6A	16.8W	○	○	○
EWS25	EWS25-5	5V	5.0A	25.0W	○	○	○
	EWS25-6	6V	4.2A	25.2W	○	○	○
	EWS25-9	9V	2.8A	25.2W	○	○	○
	EWS25-12	12V	2.2A	26.4W	○	○	○
	EWS25-15	15V	1.8A	27W	○	○	○
	EWS25-18	18V	1.5A	27W	○	○	○
	EWS25-24	24V	1.2A	28.8W	○	○	○
	EWS25-28	28V	1.0A	28W	○	○	○
EWS50	EWS50-5	5V	10.0A	50.0W	○	○	○
	EWS50-6	6V	8.4A	50.4W	○	○	○
	EWS50-9	9V	5.6A	50.4W	○	○	○
	EWS50-12	12V	4.4A	52.8W	○	○	○
	EWS50-15	15V	3.6A	54.0W	○	○	○
	EWS50-18	18V	3.2A	57.6W	○	○	○
	EWS50-24	24V	2.4A	57.6W	○	○	○
	EWS50-28	28V	2.0A	56.0W	○	○	○
EWS100	EWS100-5	5V	20A	100W	○	○	○
	EWS100-6	6V	16.7A	100.2W	○	○	○
	EWS100-9	9V	11.2A	100.8W	○	○	○
	EWS100-12	12V	8.4A	100.8W	○	○	○
	EWS100-15	15V	6.7A	100.5W	○	○	○
	EWS100-18	18V	5.6A	100.8W	○	○	○
	EWS100-24	24V	4.2A	100.8W	○	○	○
	EWS100-28	28V	3.6A	100.8W	○	○	○

Model name	Nominal output voltage	Max. output current	Max. output power	UL	CSA	EN	
EWS150	EWS150-5	5V	30A	150W	○	○	○
	EWS150-6	6V	25A	150W	○	○	○
	EWS150-9	9V	16.7A	150.3W	○	○	○
	EWS150-12	12V	12.5A	150W	○	○	○
	EWS150-15	15V	10A	150W	○	○	○
	EWS150-18	18V	8.4A	151.2W	○	○	○
	EWS150-24	24V	6.3A	151.2W	○	○	○
	EWS150-28	28V	5.4A	151.2W	○	○	○
EWS300	EWS300-2	2V	60A	120W	○	△	△
	EWS300-5	5V	60A	300W	○	○	○
	EWS300-6	6V	50A	300W	○	△	△
	EWS300-9	9V	34A	306W	○	△	△
	EWS300-12	12V	27A	324W	○	○	○
	EWS300-15	15V	22A	330W	○	○	○
	EWS300-18	18V	18A	324W	○	○	○
	EWS300-24	24V	14A	336W	○	○	○
EWS600	EWS600-2	2V	120A	240W	○	○	△
	EWS600-5	5V	120A	600W	○	○	○
	EWS600-6	6V	100A	600W	○	○	△
	EWS600-9	9V	68A	612W	○	○	△
	EWS600-12	12V	53A	636W	○	○	○
	EWS600-15	15V	43A	645W	○	○	○
	EWS600-18	18V	35A	630W	○	○	△
	EWS600-24	24V	27A	648W	○	○	○
EWS1500	EWS1500-2	2V	300A	600W	○	○	○
	EWS1500-3.3	3.3V	300A	990W	○	○	○
	EWS1500-5	5V	300A	1500W	○	○	○
	EWS1500-10	10V	150A	1500W	○	○	○
	EWS1500-12	12V	125A	1500W	○	○	○
	EWS1500-15	15V	100A	1500W	○	○	○
	EWS1500-24	24V	63A	1512W	○	○	○
	EWS1500-48	48V	32A	1536W	○	○	○

● Request customer specification for further details of specifications, outline, characteristics, etc. Read the instruction manual before usage.
● Contact us about delivery before ordering.

○ : Safety standard approved
△ : Conforms to safety standard

EWS-SERIES

■ EWS15

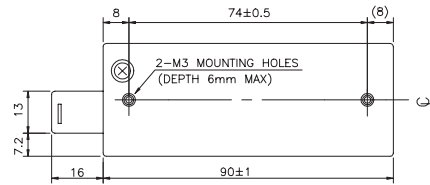
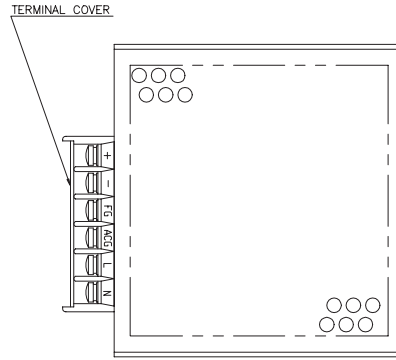
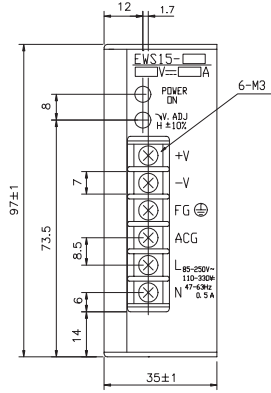

● Recommended Noise Filter

MAW-1201-22



P134

● Recommended Power Supply Fixture P198

(Unit: mm)

■ EWS25

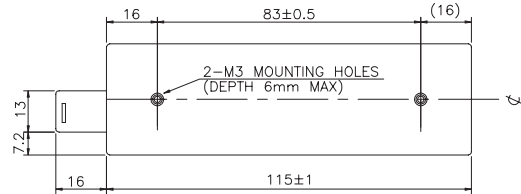
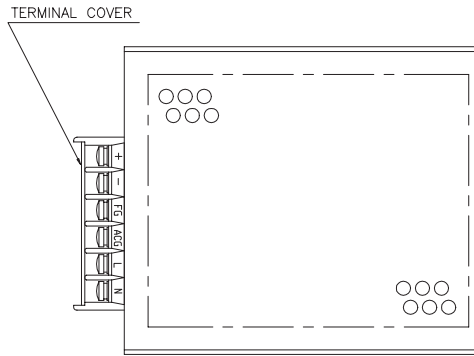
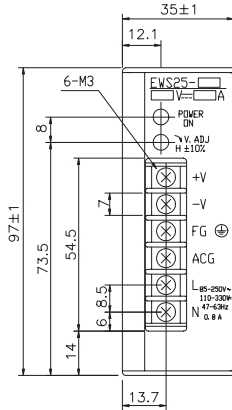

● Recommended Noise Filter

MAW-1201-22



P134

● Recommended Power Supply Fixture P198

(Unit: mm)

■ EWS50

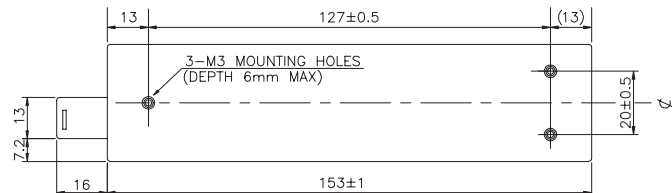
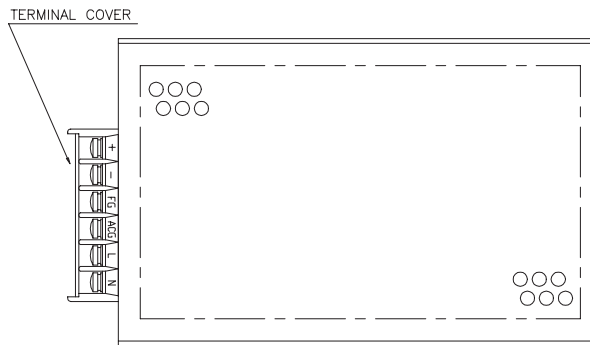
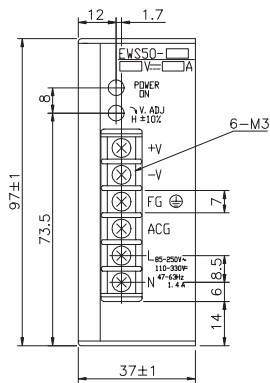

● Recommended Noise Filter

MAW-1202-22



P134

16 ● Recommended Power Supply Fixture P198

(Unit: mm)

EWS100

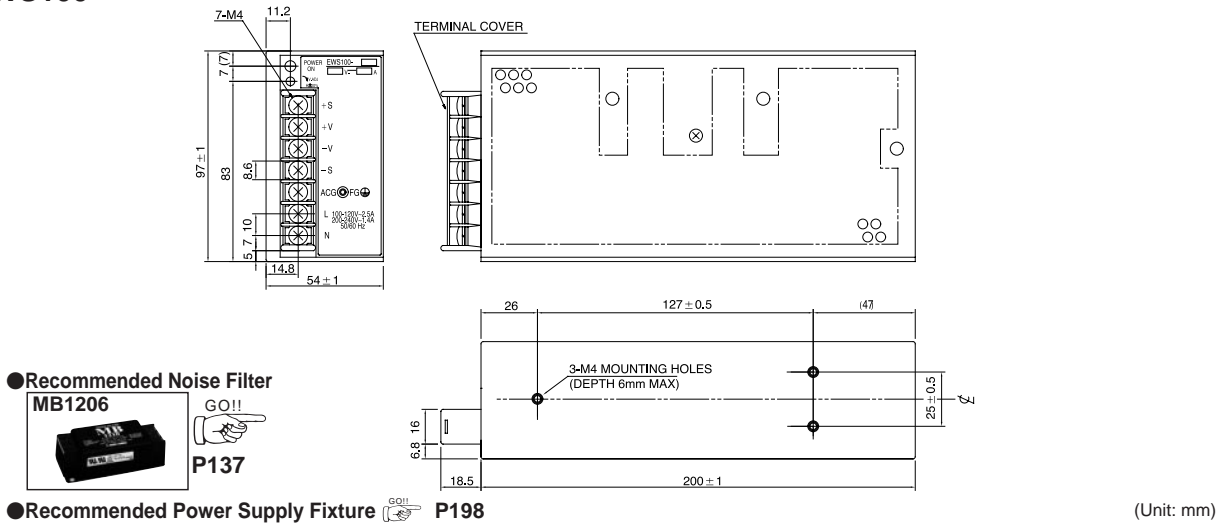

EWS150

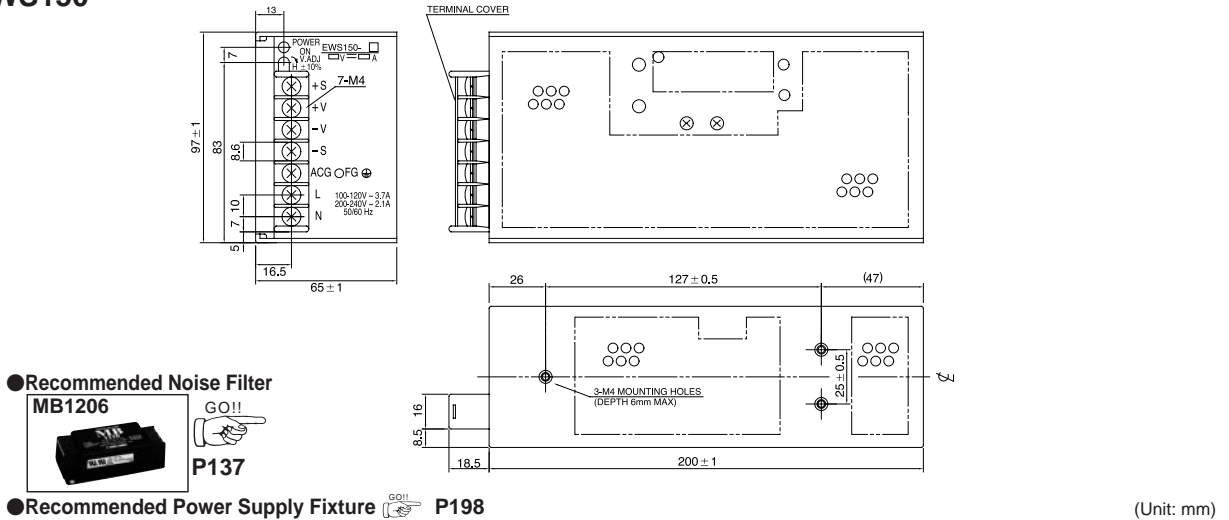

EWS300

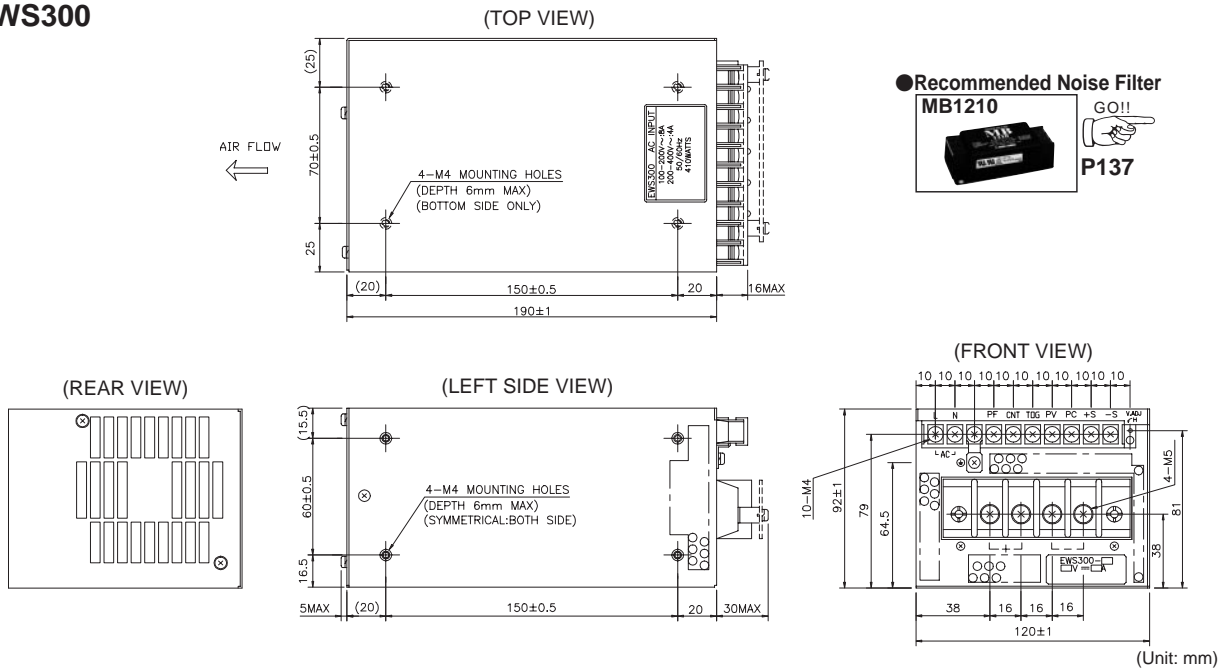

EWS-SERIES

■ EWS600

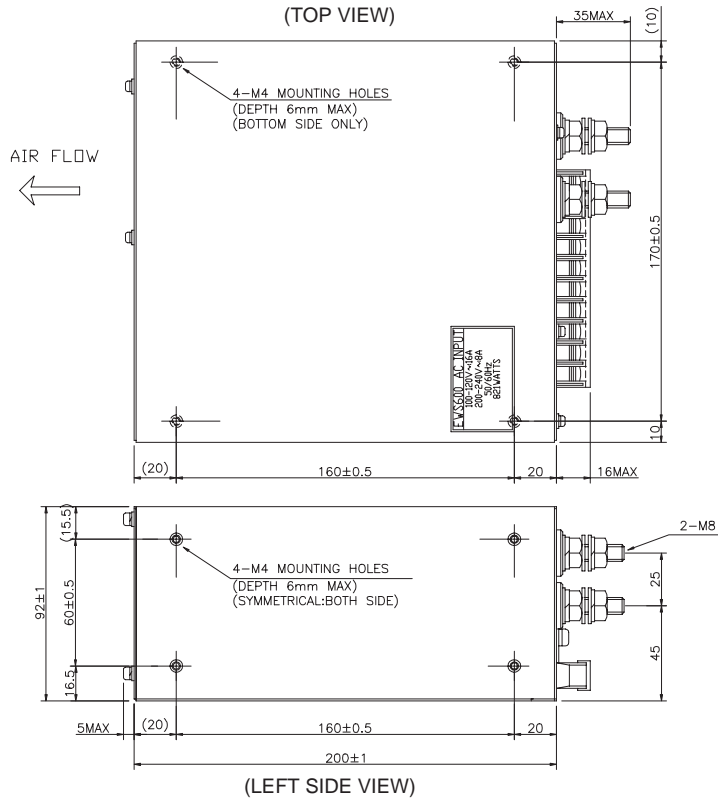

● Recommended Noise Filter

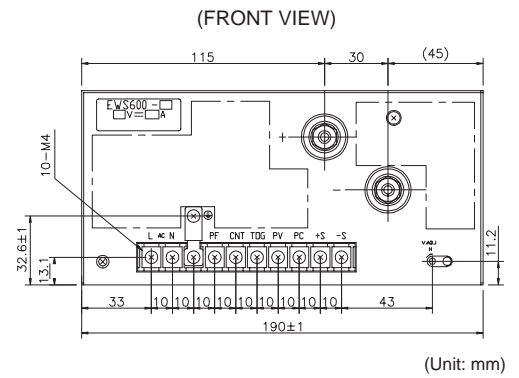

■ EWS1500

