

Features

- Efficiency up to 97%, Non isolated, no need for heatsinks
- SMD Package
- Adjustable Output Voltage
- Wide input range.(4.75V ~ 34V)
- Short circuit protection, Thermal shutdown
- Remote On/Off Control
- UL94V-0 Package Material
- Very Low Shutdown Current
- See Positive-to Negative Converter Application Note for use as a voltage inverter (alternative to LM79xx Linear)

INNOLINE
DC/DC-Converter

R-78Axx-0.5SMD Series

**0.5 AMP
SMD
Single Output**

Selection Guide

Part Number	Input Range (1) (V)	Output Voltage (V)	Adjust Range (V)	Output Current (A)	Efficiency (%)	
					Min. Vin	Max. Vin
R-78A1.5-0.5SMD	4.75 – 30	1.5	fixed	0.5	73	63
R-78A1.8-0.5SMD	4.75 – 34	1.8	1.5~3.3	0.5	82	71
R-78A2.5-0.5SMD	4.75 – 34	2.5	1.5~4.5	0.5	87	77
R-78A3.3-0.5SMD	4.75 – 34	3.3	1.8~5.5	0.5	91	81
R-78A5.0-0.5SMD	6.5 – 34	5.0	2.5~8.0	0.5	94	86
R-78A6.5-0.5SMD	8.0 – 34	6.5	3.3~11.0	0.5	95	88
R-78A9.0-0.5SMD	11 – 34	9.0	4.5~12.6	0.5	96	92
R-78A12-0.5SMD	15 – 34	12	4.5~12.6	0.5	97	94
R-78A15-0.5SMD	18 – 34	15	fixed	0.5	97	95

Note 1: 1.5V Output can be unstable with $V_{in} > 30VDC$

Description

The R-78Axx-0.5SMD series high efficiency switching regulators are ideally suited to pick-and-place mass production. The efficiency of up to 97% means that very little energy is wasted as heat. The additional features of remote on/off control and adjustable output voltages will find many uses in the Battery-powered, Industrial, Medical and Automotive markets. Low ripple and noise figures and a shutdown input current of typically only 20uA round off the specifications of this versatile SMD converter series.

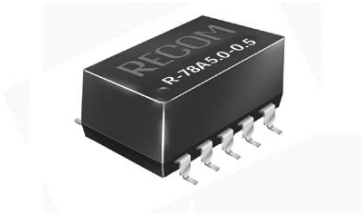

RECOM

Derating-Graph (Ambient Temperature)

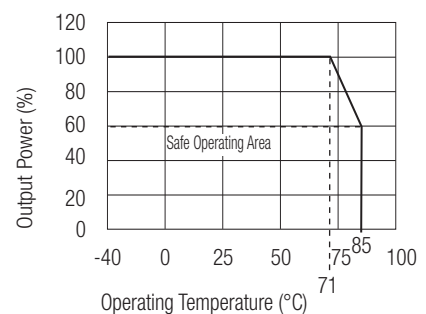

Specifications (typical at 25°C, 10% minimum load, unless otherwise specified)

Characteristics	Conditions	Min.	Typ.	Max.
Input Voltage Range (Note 1)	See Table	4.75		34.0V
Output Voltage Range	See Table	1.5		15V
Output Current	All Series	0		500mA
Output Current Limit	All Series			2000mA
Short Circuit Input Current	All Series			25mA
Internal Power Dissipation				0.4W
Short Circuit Protection			Continuous, automatic recovery	
Output Voltage Accuracy (At 100% Load)	All Series		±2	±3%
Adjustable Voltage Range	See Table 1			±50%
Line Voltage Regulation (Vin = min. to max. at full load)	1.5V to 6.5V		0.2	0.4%
	9V to 15V		0.1	0.2%
Load Regulation (10 to 100% full load)	1.5V to 6.5V		0.7	1.0%
	9V to 15V		0.25	0.4%
Dynamic Load Stability	100% <-> 50% load		±75V	
	100% <-> 10% load			±100mV
Ripple & Noise (without Output Capacitor)	1.5V to 6.5V		20mVp-p	30mVp-p
	9V to 15.5V		30mVp-p	40mVp-p
Temperature Coefficient	-40°C ~ +85°C ambient			0.015%/°C
Max capacitance Load				220µF
Switching Frequency		280	330	380kHz
Quiescent Current	Vin = min. to max. at 0% load		5	7mA
Shutdown Input Current			20	35µA
Remote On/Off Threshold Voltage		0.8	1.2	1.6V
ON/OFF Remote Control	ON: Open or 1.6<Vr<5V, OFF: GND or 0<Vr<1.6V			Ir=1.8µA typ.
Operating Temperature Range (with derating)		-40°C		+85°C
Switch On/Off Time	(using Remote On/Off Control)			50ms
Operating Case Temperature				+100°C
Storage Temperature Range		-55°C		+125°C
Case Thermal Impedance				70°C / W
Thermal Shutdown	Internal IC junction		+160°C	
Package Weight				2.7g
MTBF (+25°C)	Detailed Information see Application Notes chapter "MTBF" using MIL-HDBK 217F			21098 x 10 ³ hours
(+71°C)				4214 x 10 ³ hours

Standard Application Circuit

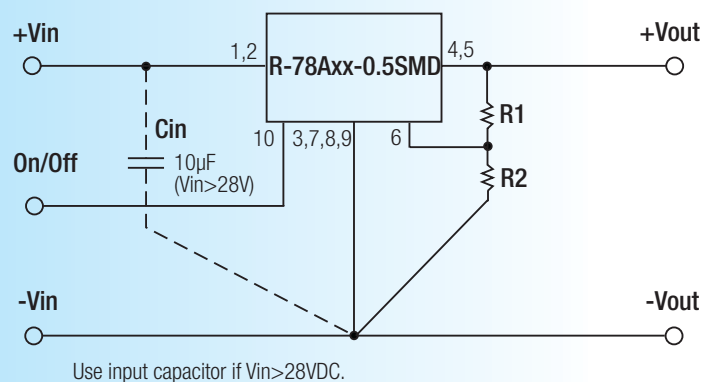

Add a blocking diode to Vout if current can flow backwards into the output, as this can damage the converter..
See Application Examples for details.

Characteristics

Efficiency

Ripple

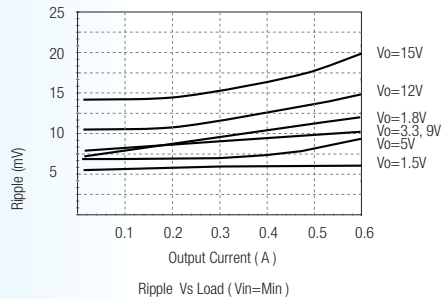
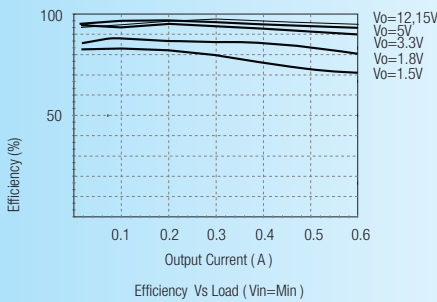
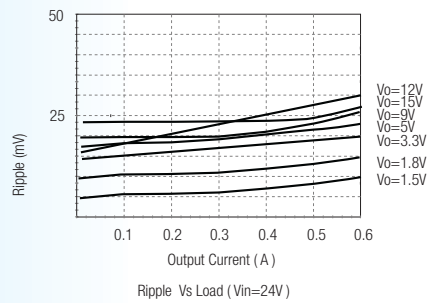
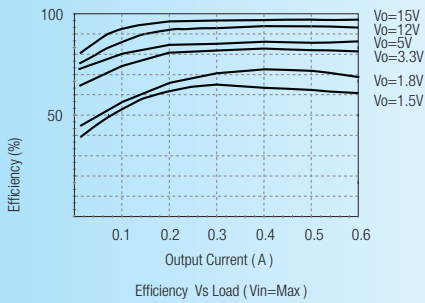
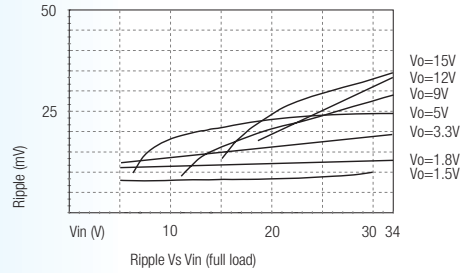
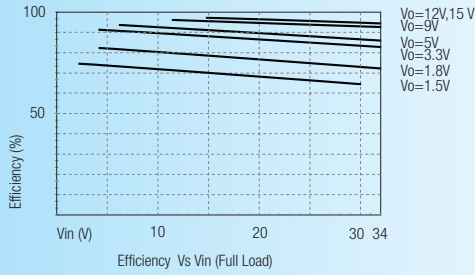

Application Examples

Flash Memory Program Voltage Switcher

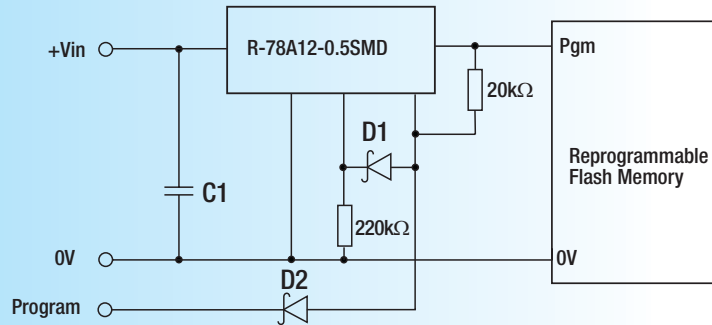

D1, D2: schottky Diode

"Program" = 0V, Pgm Pin = +5V

"Program" = high, Pgm Pin = +12,6V

Output protection from external voltage

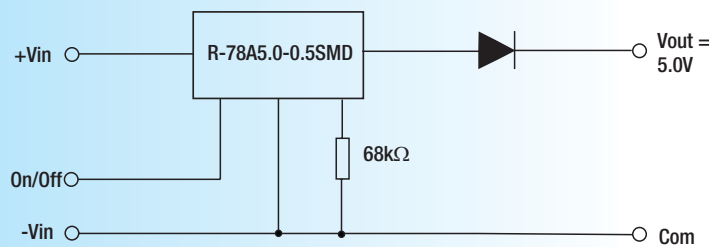

Converter Output set to 5.7V to compensate for diode drop

DC/DC Converter (1:1)

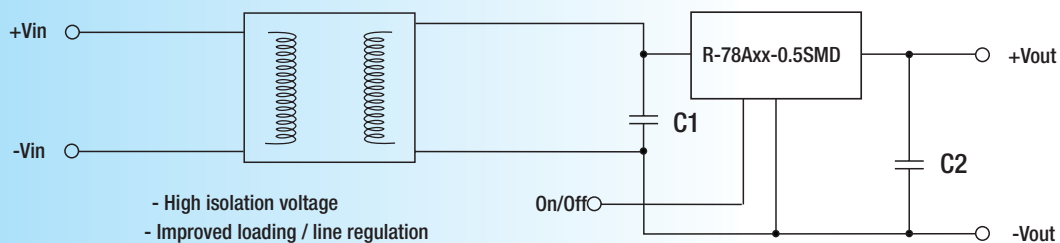

- High isolation voltage
- Improved loading / line regulation
- Wide Input Voltage Range
- Point-of-Load Architecture
- Remote On/Off Control

C1: Required (further decoupling filtering may be necessary between the two converters), C2: Optional

Table 1: Adjustment Resistor Values

0.5Adc	R-78A1.8 -0.5SMD		R-78A2.5 -0.5SMD		R-78A3.3 -0.5SMD		R-78A5.0 -0.5SMD		R-78A6.5-78A9.0 -0.5SMD		-0.5SMD		-0.5SMD	
Vout (nom.)	1.8Vdc		2.5Vdc		3.3Vdc		5.0Vdc		6.5Vdc		9.0Vdc		12.0Vdc	
Vout (adj)	R1	R2	R1	R2	R1	R2	R1	R2	R1	R2	R1	R2	R1	R2
1.5 (V)	3K Ω		200 Ω											
1.8 (V)			12K Ω											
2.5 (V)		12K Ω			21K Ω		5.6K Ω							
3.0 (V)		4.7K Ω	50K Ω		88.4K Ω		17K Ω							
3.3 (V)		2.7K Ω	29K Ω				27K Ω		6.7K Ω					
3.6 (V)			19.4K Ω		69K Ω		42K Ω		14K Ω					
3.9 (V)			14k Ω		30.5K Ω		58K Ω		23K Ω					
4.5 (V)			8k Ω		12.1k Ω		180K Ω		49K Ω		26K Ω		17K Ω	
4.9 (V)					7.6k Ω		850K Ω		77k Ω		36K Ω		24K Ω	
5.0 (V)					6.8k Ω				86k Ω		39K Ω		26K Ω	
5.1 (V)					6.2k Ω		540k Ω		97K Ω		42K Ω		28K Ω	
5.5 (V)					4k Ω		71k Ω		160K Ω		56K Ω		36K Ω	
6.5 (V)							20.2k Ω				112K Ω		63K Ω	
8.0 (V)							7.2k Ω			26K Ω	400K Ω		125K Ω	
9.0 (V)										11.3K Ω			200K Ω	
10 (V)										5.2K Ω		59K Ω	345K Ω	
11 (V)										1.8K Ω		18.5K Ω	740K Ω	
12 (V)												5.2K Ω		
12.6 (V)												830K Ω		216K Ω

Package Style and Pinning (mm)

SMD 10Pin Package

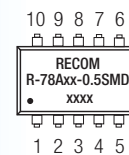
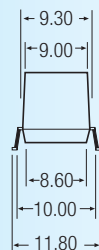
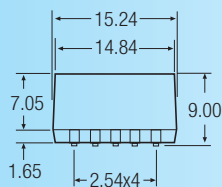

Pin Connections

Pin #	Function
1,2	+Vin
3,7,8,9	GND
4,5	+Vout
6	V adj
10	Remote On/Off

xx.x ±0.5mm
xx.xx ±0.25mm

Recommended Footprint Details

