

jb[®] Motor Starting / Running Capacitor – JFS

■ FEATURES

- Electrical apparatus use metalized film with precisely quality control.
- Low D.F. (dissipation factor), lower temperature rise.
- High I.R. (insulation resistance) small size.
- High safety & high reliability.
- Durability and characteristics of frequency, etc.

■ SPECIFICATIONS

- Operating Condition -25°C~+70°C
- Capacitance Range 1uF~20uF(JFS-A~D, JFS-5~7, JFS-9)
1uF~100uF(JFS-11~18)
- Capacitance Tolerance J(±5%), K(±10%)
- Rated Voltage 250V 450V (AC)
- Withland Voltage AC≥2U_R 2S(I_{max}≤1.3 I_{nA})
- Dissipation Factor ≤0.003 1KHz(JFS-A~D, JFS-5~7, JFS-9)
≤0.004 1KHz(JFS-11~18)
- Insulation Resistance ≥3000S



JFS-A

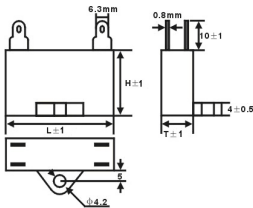

JFS-B

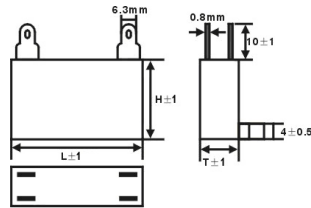

JFS-C

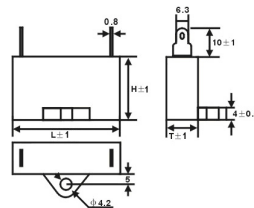

JFS-D

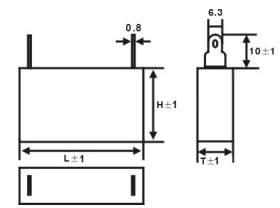

JFS-1

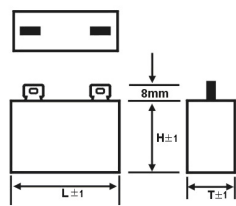

JFS-2

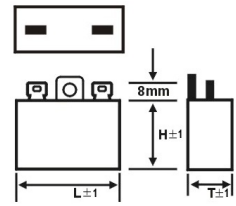

JFS-3

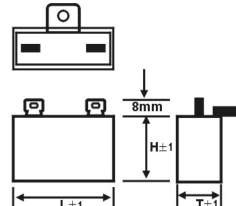

JFS-4

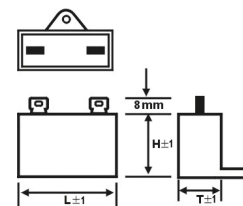

JFS-5

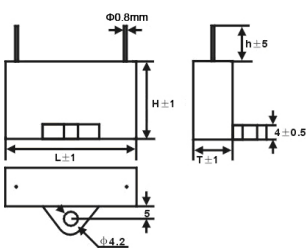

JFS-6

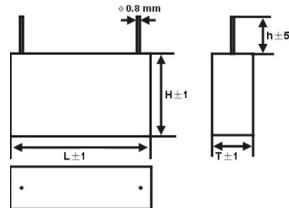

JFS-7

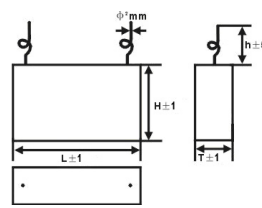

JFS-8

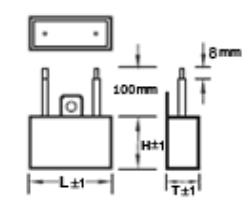

JFS-9

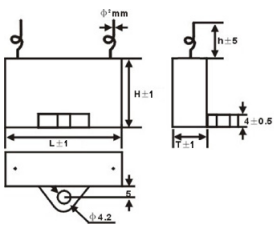

jb[®] Capacitors Company

Web-site: www.jbcapacitors.com

E-mail: info@jbcapacitors.com

Tel : (852)2790 5091

Fax: (852)8169 8283

jb[®] Motor Starting / Running Capacitor – JFS

JFS-10

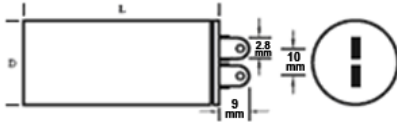

JFS-11

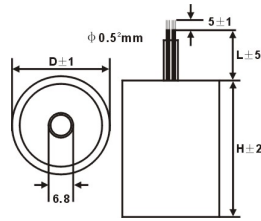

JFS-12

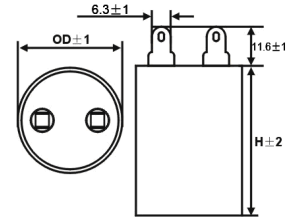

JFS-13 (only for 30x60)

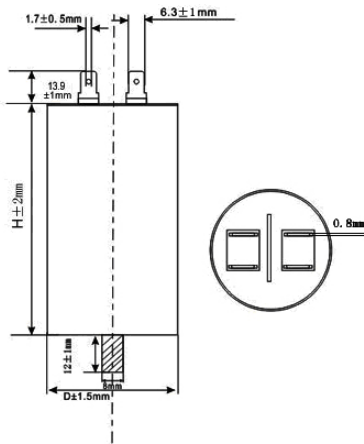

JFS-13

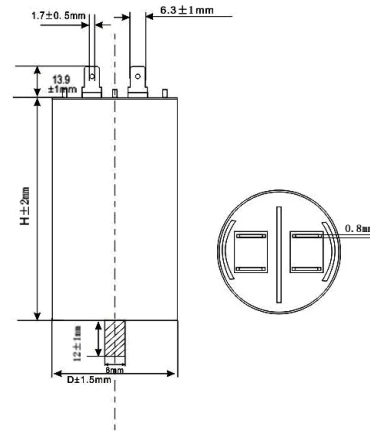

JFS-14

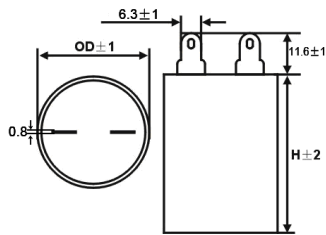

JFS-15

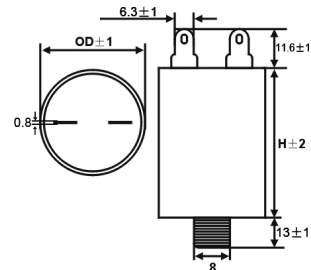

JFS-16

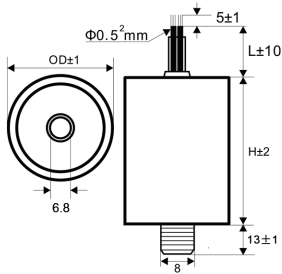

JFS-17

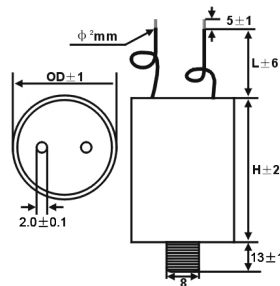

JFS-18

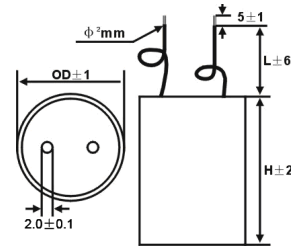

Please visit our website to get more update data, those data & specification are subject to change without notice.

jb[®] Capacitors Company

Web-site: www.jbcapacitors.com

E-mail: info@jbcapacitors.com

Tel : (852)2790 5091

Fax: (852)8169 8283



Motor Starting / Running Capacitor – JFS

■ Dimensions (mm)

CAP	JFS-A,JFS-C,JFS-5,JFS-9						JFS-B,JFS-D,JFS-6,JFS-7					
	250VAC			450VAC			250VAC			450VAC		
uF	L	T	H	L	T	H	L	T	H	L	T	H
0.5	26.5	12.5	21	26.5	12.5	21	26.5	12	20	25.5	12	20
1	26.5	12.5	21	32	14	24	26.5	12	20	32	14	25
2	32	14	24	37	17	28	32	14	25	37	17	28
2.5	32	14	24	37	17	28	32	14	25	37	17	28
3	32	14	24	38	20	30	32	14	25	38	20	30
5	37	17	28	47	20	34	37	17	28	47	20	34
6	37	17	28	47	23	34	37	17	28	47	23	34
8	47	17.5	33	47	28	34	47	18	32	47	28	34
10	47	17.5	33	47	32	40	47	18	32	47	30	40
12	47	23	34	47	32	43	47	23	34	--	--	--
15	47	25	34	--	--	--	47	25	34	--	--	--
20	47	28	37	--	--	--	47	28	37	--	--	--

CAP	JFS-13,16,17				JFS-11,12,18				JFS-15				JFS-14			
	250VAC		450VAC		250VAC		450VAC		250VAC		450VAC		250VAC		450VAC	
uF	OD	H	OD	H	OD	H	OD	H	OD	H	OD	H	OD	H	OD	H
1	26	55	26	55	26	55	26	55	26	55	26	55	26	55	26	55
2	26	55	26	55	26	55	26	55	26	55	26	55	26	55	26	55
3	26	55	26	55	26	55	26	55	26	55	26	55	26	55	26	55
5	26	55	34	55	26	55	34	55	26	55	34	55	26	55	34	55
6	26	55	34	55	26	55	34	55	26	55	34	55	26	55	34	55
8	26	55	36	65	26	55	36	60	26	55	36	60	26	55	34	55
10	34	55	36	65	34	55	36	60	34	55	36	60	26	55	36	55
12	34	55	45	75	34	55	36	70	34	55	36	70	26	55	36	65
16	34	55	45	75	34	55	45	70	34	55	45	70	34	55	45	65
20	34	55	45	75	34	55	45	70	34	55	45	70	34	55	45	65
25	36	65	50	85	36	60	45	80	36	60	45	80	34	55	45	75
30	36	65	50	85	36	60	50	80	36	60	50	80	34	55	50	75
40	45	75	45	125	36	70	45	120	36	70	45	120	36	65	45	115
50	45	75	50	125	45	70	50	120	45	70	50	120	45	65	50	115
60	50	85	60	125	50	80	60	120	50	80	60	120	45	75	60	115
80	45	125	60	145	45	120	60	140	45	120	60	140	45	115	60	135
100	50	125	65	145	50	120	65	140	50	120	65	140	50	115	65	135

Please visit our website to get more update data, those data & specification are subject to change without notice.

jb[®] Capacitors Company

Web-site: www.jbcapacitors.com

E-mail: info@jbcapacitors.com

Tel : (852)2790 5091

Fax: (852)8169 8283