

Power Solid-state Relay G3PA-(VD)

Extremely Thin Relays Integrated with Heat Sink

- Downsizing achieved through optimum design of heat sink.
- Mounting possible via screws or via DIN track.
- Close mounting possible for linking terminals. (Except for G3PA-260B-VD, G3PA-450B-VD-2.)
- Applicable with 3-phase loads.
- Replaceable power element cartridges.
- Conforms to VDE 0160 (finger protection), with a dielectric strength of 4,000 V between input and load.
- Conforms to VDE 0805, IEC 950.
- Approved by UL, CSA, and VDE (reinforced insulation).



Ordering Information

List of Models

Model	Isolation	Zero cross function	Indicator	Applicable output load	Rated input voltage
G3PA-210B-VD	Phototriac coupler	Yes	Yes	10 A at 24 to 240 VAC	5 to 24 VDC
G3PA-220B-VD				20 A at 24 to 240 VAC	
G3PA-240B-VD				40 A at 24 to 240 VAC	
G3PA-260B-VD				60 A at 24 to 240 VAC	
G3PA-210BL-VD	No	No	No	10 A at 24 to 240 VAC	
G3PA-220BL-VD				20 A at 24 to 240 VAC	
G3PA-240BL-VD				40 A at 24 to 240 VAC	
G3PA-260BL-VD				60 A at 24 to 240 VAC	
G3PA-210B-VD	Yes	Yes	Yes	10 A at 24 to 240 VAC	24 VAC
G3PA-220B-VD				20 A at 24 to 240 VAC	
G3PA-240B-VD				40 A at 24 to 240 VAC	
G3PA-260B-VD				60 A at 24 to 240 VAC	
G3PA-420B-VD				20 A at 180 to 400 VAC	12 to 24 VDC
G3PA-430B-VD				30 A at 180 to 400 VAC	
G3PA-420B-VD-2				20 A at 200 to 480 VAC	
G3PA-430B-VD-2				30 A at 200 to 480 VAC	
G3PA-450B-VD-2				50 A at 200 to 480 VAC	

SSR

Replacement Parts

Name	Carry current	Load voltage	Model	Applicable SSR	Conforms to VDE
Power Device Cartridge	10 A	19 to 264 VAC	G32A-A10-VD DC5-24	G3PA-210B-VD DC5-24	Yes
			G32A-A10L-VD DC5-24	G3PA-210BL-VD DC5-24	
			G32A-A10-VD AC24	G3PA-210B-VD AC24	
	20 A		G32A-A20-VD DC5-24	G3PA-220B-VD DC5-24	
			G32A-A20L-VD DC5-24	G3PA-220BL-VD DC5-24	
			G32A-A20-VD AC24	G3PA-220B-VD AC24	
	40 A		G32A-A40-VD DC5-24	G3PA-240B-VD DC5-24	
			G32A-A40L-VD DC5-24	G3PA-240BL-VD DC5-24	
			G32A-A40-VD AC24	G3PA-240B-VD AC24	
	60 A	G32A-A60-VD DC5-24	G3PA-260B-VD DC5-24		
		G32A-A60L-VD DC5-24	G3PA-260BL-VD DC5-24		
		G32A-A60-VD AC24	G3PA-260B-VD AC24		
	20 A	150 to 440 VAC	G32A-A420-VD DC12-24	G3PA-420B-VD DC12-24	
	30 A		G32A-A430-VD DC12-24	G3PA-430B-VD DC12-24	
	20 A	180 to 528 VAC	G32A-A420-VD-2 DC12-24	G3PA-420B-VD-2 DC12-24	
	30 A		G32A-A430-VD-2 DC12-24	G3PA-430B-VD-2 DC12-24	
	50 A		G32A-A450-VD-2 DC12-24	G3PA-450B-VD-2 DC12-24	
	10 A	75 to 264 VAC	G32A-A10	G3PA-210B DC5-24	No
	20 A		G32A-A20	G3PA-220B DC5-24	
	40 A		G32A-A40	G3PA-240B DC5-24	
20 A	180 to 528 VAC	G32A-A420	G3PA-420B DC5-24		
30 A		G32A-A430	G3PA-430B DC5-24		

■ Other Units (Order Separately)

Units that Enable 2-line Switching of 3-phase Power

Name	Current flow	Model	Applicable SSR
Short-circuit Unit	10 A	G32A-D20	G3PA-210B-VD, G3PA-210BL-VD
	20 A		G3PA-220B-VD, G3PA-220BL-VD G3PA-420B-VD, G3PA-420B-VD-2
	30 A	G32A-D40	G3PA-430B-VD, G3PA-430B-VD-2
	40 A		G3PA-240B-VD, G3PA-240BL-VD

Specifications

■ Ratings (at 25°C)

Input

Model	Rated voltage	Voltage range	Input current impedance	Voltage level	
				Must operate voltage	Must release voltage
G3PA-210B-VD	5 to 24 VDC	4 to 30 VDC	7 mA max.	4 VDC max.	1 VDC min.
G3PA-220B-VD					
G3PA-240B-VD					
G3PA-260B-VD					
G3PA-210BL-VD	5 to 24 VDC	4 to 30 VDC	20 mA max.	4 VDC max.	1 VDC min.
G3PA-220BL-VD					
G3PA-240BL-VD					
G3PA-260BL-VD					
G3PA-210B-VD	24 VAC	19.2 to 26.4 VAC	1.4 kΩ±20%	19.2 VAC max.	4.8 VAC min.
G3PA-220B-VD					
G3PA-240B-VD					
G3PA-260B-VD					
G3PA-420B-VD	12 to 24 VDC	9.6 to 30 VDC	7 mA max.	9.2 VDC max.	1 VDC min.
G3PA-430B-VD					
G3PA-420B-VD-2					
G3PA-430B-VD-2					
G3PA-450B-VD-2					

Output

Model	Applicable load			
	Rated load voltage	Load voltage range	Load current	Inrush current
G3PA-210B(L)-VD	24 to 240 VAC (50/60 Hz)	19 to 264 VAC (50/60 Hz)	0.1 to 10 A	150 A (60 Hz, 1 cycle)
G3PA-220B(L)-VD			0.1 to 20 A	220 A (60 Hz, 1 cycle)
G3PA-240B(L)-VD			0.5 to 40 A	440 A (60 Hz, 1 cycle)
G3PA-260B(L)-VD			0.5 to 60 A	440 A (60 Hz, 1 cycle)
G3PA-420B-VD	180 to 400 VAC (50/60 Hz)	150 to 440 VAC (50/60 Hz)	0.5 to 20 A	220 A (60 Hz, 1 cycle)
G3PA-430B-VD			0.5 to 30 A	440 A (60 Hz, 1 cycle)
G3PA-420B-VD-2	200 to 480 VAC (50/60 Hz)	180 to 528 VAC (50/60 Hz)	0.5 to 20 A	220 A (60 Hz, 1 cycle)
G3PA-430B-VD-2			0.5 to 30 A	440 A (60 Hz, 1 cycle)
G3PA-450B-VD-2			0.5 to 50 A	440 A (60 Hz, 1 cycle)

Refer to *Engineering Data* for further details.

■ Characteristics

Item	G3PA-210B(L)-VD	G3PA-220B(L)-VD	G3PA-240B(L)-VD	G3PA-260B(L)-VD	G3PA-420B-VD	G3PA-420B-VD-2	G3PA-430B-VD	G3PA-430B-VD-2	G3PA-450B-VD-2	
Operate time	1/2 of load power source cycle + 1 ms max. (DC Input, -B models) 1 1/2 of load power source cycle + 1 ms max. (AC Input) 1 ms max. (-BL models)									
Release time	1/2 of load power source cycle + 1 ms max. (DC Input) 1 1/2 of load power source cycle + 1 ms max. (AC Input)									
Output ON voltage drop	1.6 V (RMS) max.					1.8 V (RMS) max.				
Leakage current	5 mA max. (at 120 VAC) 10 mA max. (at 230 VAC)		10 mA max. (at 120 VAC) 20 mA max. (at 230 VAC)		20 mA max. (at 400 VAC)	20 mA max. (at 480 VAC)	20 mA max. (at 400 VAC)	20 mA max. (at 480 VAC)		
I ² t	260 A ² S		810 A ² S		260 A ² S			810 A ² S		810 A ² S
Insulation resistance	100 MΩ min. (at 500 VDC)									
Dielectric strength	4,000 VAC, 50/60 Hz for 1 min									
Vibration resistance	Destruction: 10 to 55 to 10 Hz, 0.375–mm single amplitude (0.75-mm double amplitude) (Mounted to DIN track)									
Shock resistance	Destruction: 300 m/s ² (mounted to DIN track)									
Ambient temperature	Operating: –30°C to 80°C (with no icing or condensation) Storage: –30°C to 100°C (with no icing or condensation)									
Approved standards	UL508, CSA C22.2 (No.14, No.950), EN60950 File No. 5915ÜG				UL508, CSA C22.2 (No.14), EN60947-4-3 File No. 6642ÜG	UL508, CSA C22.2 (No.14), EN60947-4-3 File No. 133127ÜG	UL508, CSA C22.2 (No.14), EN60947-4-3 File No. 6642ÜG	UL508, CSA C22.2 (No.14), EN60947-4-3 File No. 133127ÜG		
Ambient humidity	Operating: 45% to 85%									
Weight	Approx. 260 g	Approx. 340 g	Approx. 460 g	Approx. 900 g	Approx. 290 g	Approx. 290 g	Approx. 410 g	Approx. 410 g	Approx. 900 g	

Operation

■ Replacement Parts

G32A-A Power Device Cartridge

The G32A-A Power Device Cartridge (a Triac Unit) can be replaced with a new one. When the temperature indicator has changed from pink to red, the triac circuitry may have malfunctioned possibly by an excessive flow of current, in which case, dismantle the damaged cartridge for replacement.

The damaged cartridge can be replaced with a new one without disconnecting the wires from the G3PA.

Improve the heat radiation efficiency of the G3PA before replacing the cartridge.

The G32A-A Power Device Cartridge can withstand an excessive current for a short period of time, such as may be caused accidentally by the short circuitry of the load, in which case the temperature indicator will not turn red.

Appearance

G32A-A10(L)-VD

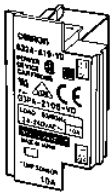

G32A-A20(L)-VD

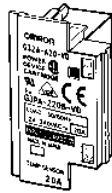

G32A-A40(L)-VD

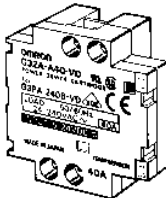

G32A-A60(L)-VD

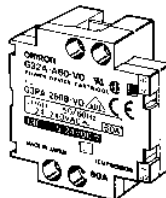

G32A-A10



G32A-A20

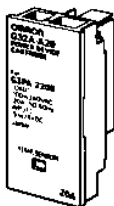

G32A-A40

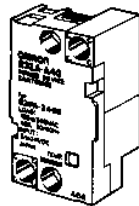

G32A-A420-VD(-2)



G32A-A430-VD(-2)

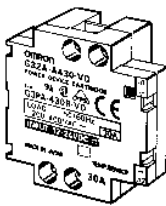

G32A-A450-VD-2

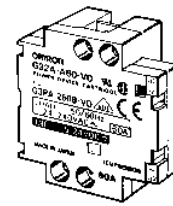

Replacing Power Device Cartridges

When replacing Power Device Cartridges, use the specified model. Using a Power Device Cartridge other than the specified one will result in faulty operation and destruction of the elements.

Noise Terminal Voltage according to EN55011

Conformance to EN55011 is possible if a capacitor is connected to the load power supply as shown in the diagram below. (G3PA-VD)
Recommended capacitor: NISSEI ELECTRIC Co., LTD, TYPE R40 (MKT Series), 1 μF (Japan only).

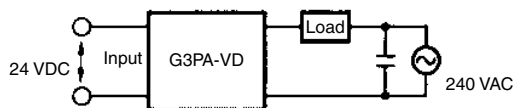

Loss Time

The loss time increases for low voltages and currents. Ensure that the loss time does not increase to an inappropriate level.

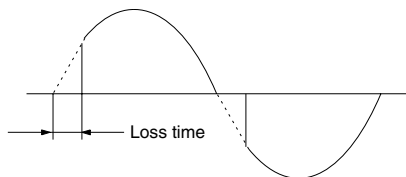

Caution

Be sure to turn OFF the power supply when replacing the Cartridge. Supplying power with the Cartridge removed may result in malfunction.

SSR

■ Replacement Procedure

G32A-A10(L)-VD/G32A-A20(L)-VD/G32A-A420-VD(-2)

Use the special tool (provided) to extract the cartridge for replacement with a new one.

Extraction

Follow the procedures below to dismantle the Power Device Cartridge from the G3PA.

1. **Switch off the power.**
2. Remove the terminal cover.
3. Hook the indented part of the cartridge with the tool and pull up on the cartridge to remove it.

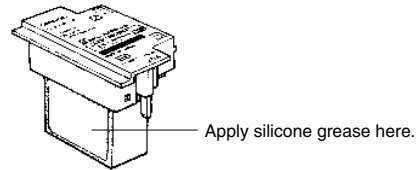
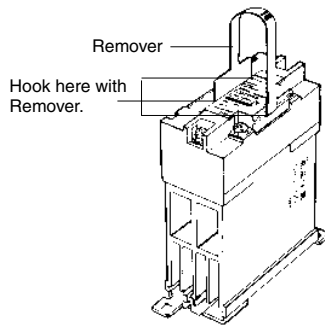

2. Make sure that there is no dust or pieces of wire on the heat radiator of the G32A-A or the G3PA.
3. Insert the cartridge into the opening of the G3PA so that the letters on the cartridge and those on the G3PA are in the same direction and side A and side B are even.

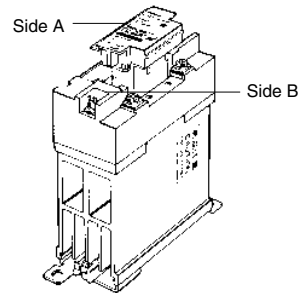

Mounting

Follow the procedures below to mount the Power Device Cartridge on the G3PA.

1. Apply silicone grease (provided with the G32A-A) to the entire surface of the heat radiator.

4. Attach the terminal cover.
5. Switch on the power and check the G3PA to be sure it works properly.

G32A-A40(L)-VD/G32A-A60(L)-VD/G32A-A430-VD(-2)/G32A-A450-VD-2

The G32A Power Device Cartridge is mounted and secured with screws to the G3PA Unit.

Extraction

Follow the procedures below to dismantle the G32A-A Power Device Cartridge from the G3PA.

1. **Switch off the power.**
2. Remove the terminal cover.
3. Loosen the two centered screws on the sides to dismantle the cartridge. The screws are connected to terminals 1 and 2.

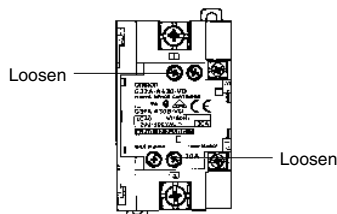

4. Loosen the screws on both the corners.

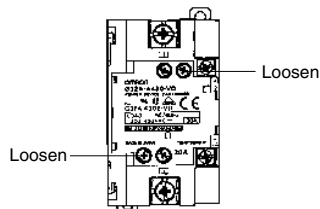

5. Hold the indented part of both the corners to dismantle the cartridge.

Mounting

1. Apply silicone grease to the entire surface of the heat radiator.

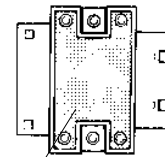

2. Make sure that there is no dust or pieces of wire on the radiator of the G32A-A or the G3PA.

3. Insert the cartridge into the opening of the G3PA so that side A and side B are even.

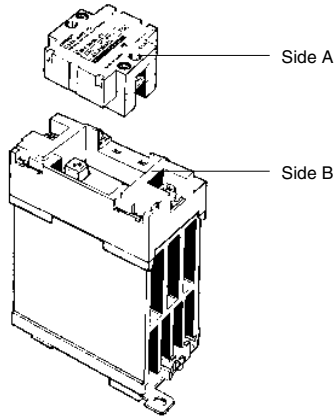

4. Tighten the screws on both the corners with a tightening torque of 0.59 to 0.78 N-m.
5. Tighten the screws on both the sides with a tightening torque of 0.59 to 0.78 N-m.
6. Attach the terminal cover.
7. Switch on the power and check the G3PA to be sure it works properly.

■ Linking Terminal Connection

- Connecting with linking terminal for G3PA-210B(L)-VD, -220B(L)-VD, -240B(L)-VD and G3PA-420B-VD(-2), G3PA-430B-VD(-2).

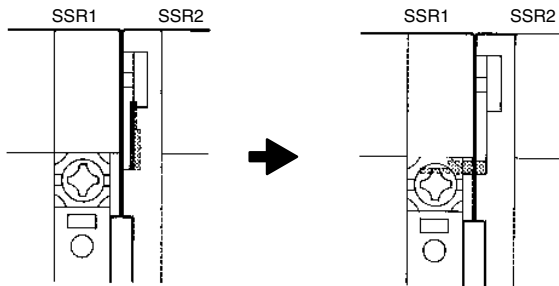

1. When SSRs are close mounted, loosen the M3.5 Sems screw and flip the linking terminal down.
2. Insert the linking terminal securely into the center of the screw and tighten the screw.

- Connecting with linking terminal for G32A.

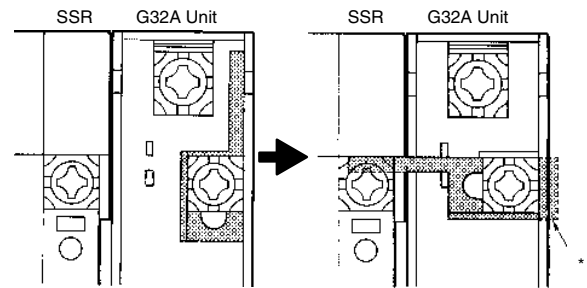

1. When SSR are close mounted, loosen the M3.5 Sems screw on the G32A and flip the linking terminal down.
2. Insert the linking terminal securely into the center of the screw and tighten the screw. Ensure that the linking terminal does not protrude.

* The cover will not fit if the terminal protrudes.

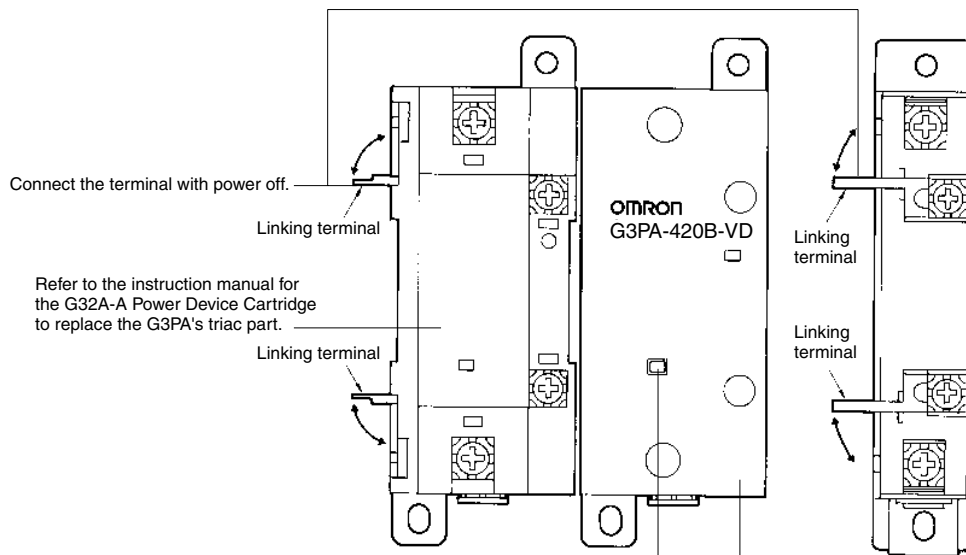

When the temperature indicator has turned from pink to red, the G32-A-A Power Device Cartridge may have malfunctioned, in which case the cartridge must be replaced with a new one.

Use the terminal cover to prevent accidents due to electric shock.

SSR

Mounting

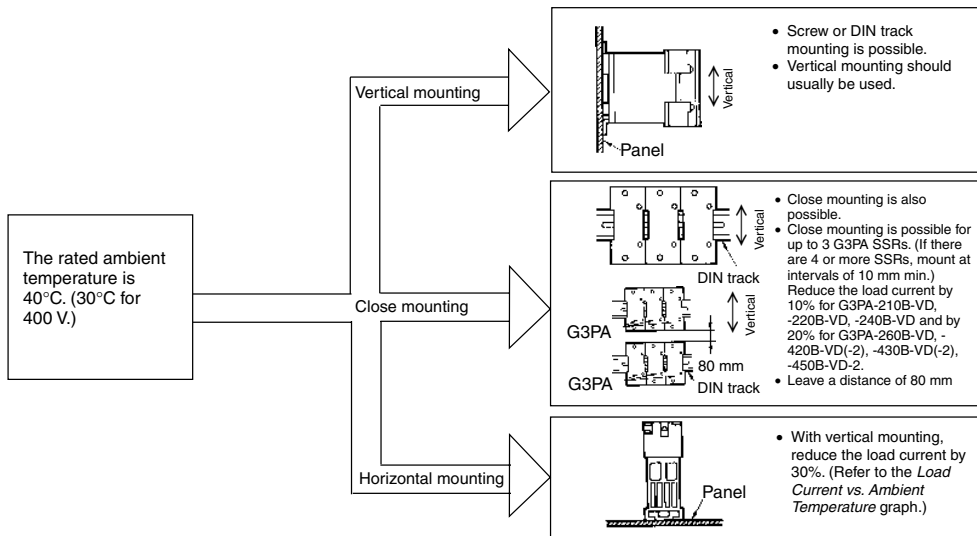

Note: Leave a distance of 60 mm min. between SSRs and ducts (especially above the SSR).

Engineering Data

Load Current vs. Ambient Temperature

Horizontal Mounting to Ground

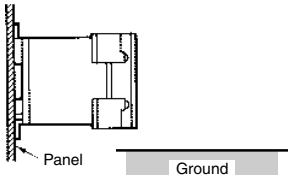

G3PA-210B(L)-VD, G3PA-220B(L)-VD

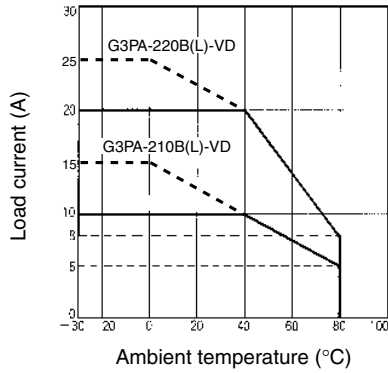

G3PA-240B(L)-VD

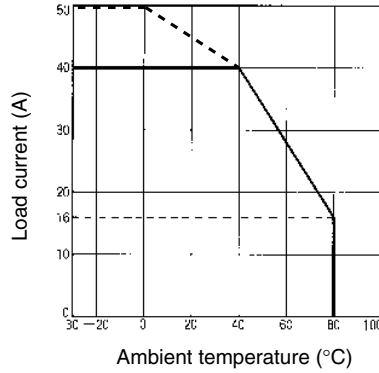

G3PA-260B(L)-VD

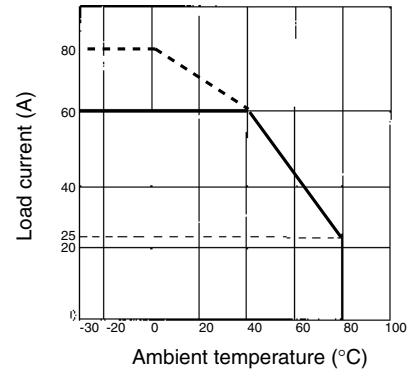

G3PA-420B-VD, G3PA-420B-VD-2

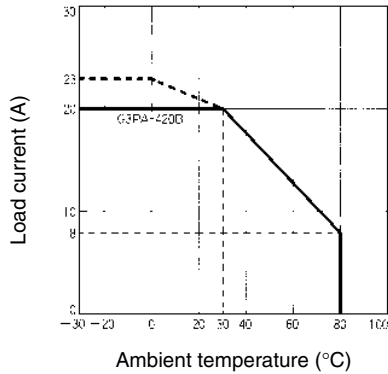

G3PA-430B-VD, G3PA-430B-VD-2

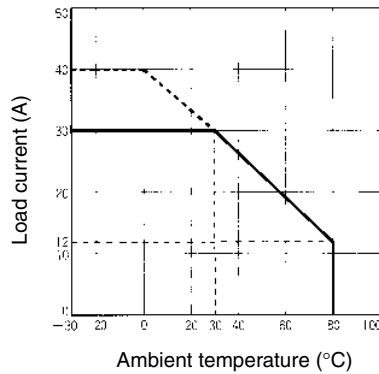

G3PA-450B-VD-2

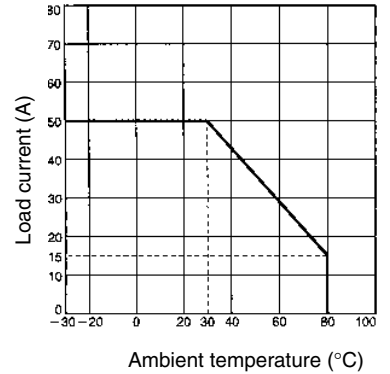

Note: Close mounting is possible for a maximum of three Units by reducing the load current by 20%. (A minimum clearance of 10 mm must be provided when mounting four or more Units.)

SSR

Input Voltage vs. Input Current

G3PA-2□0B-VD

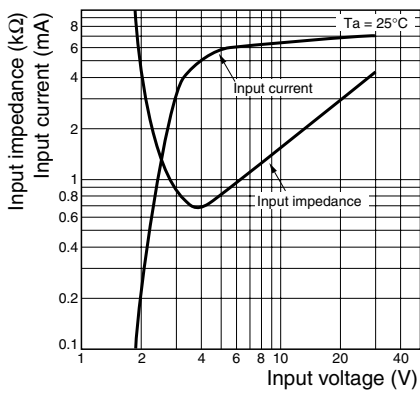

G3PA-4□0-VD, G3PA-4□-VD-2

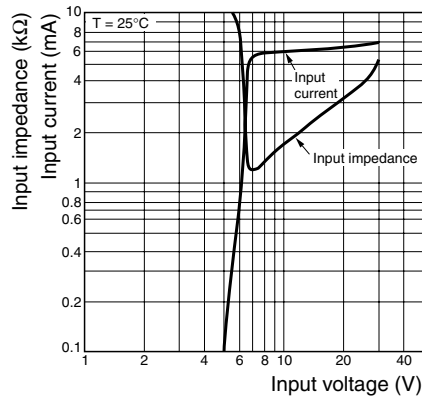

Vertical Mounting to Ground

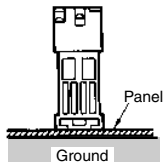

G3PA-210B(L)-VD, G3PA-220B(L)-VD

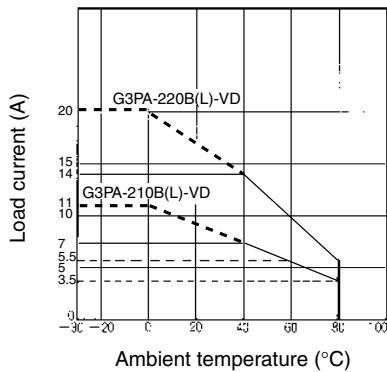

G3PA-240B(L)-VD

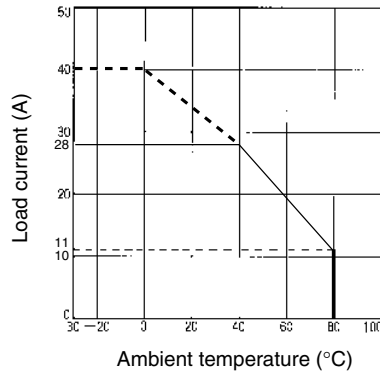

G3PA-260B(L)-VD

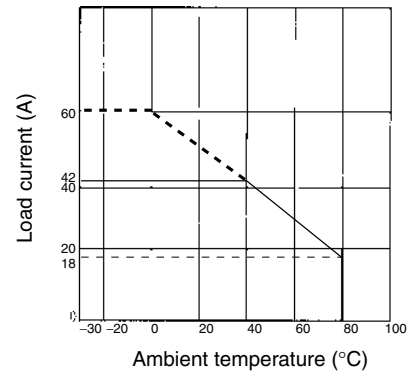

G3PA-420B-VD, G3PA-430B-VD
G3PA-420B-VD-2, G3PA-430B-VD-2

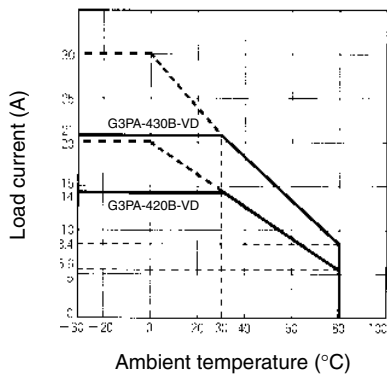

G3PA-450B-VD-2

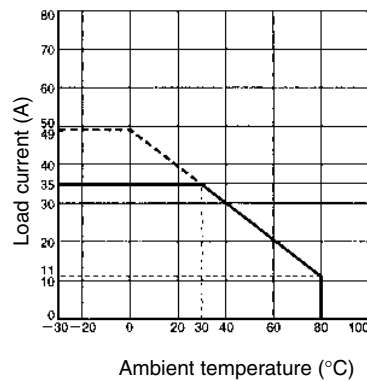

Close Mounting (Up to Three)

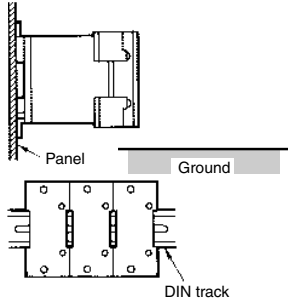

G3PA-210B(L)-VD, G3PA-220B(L)-VD

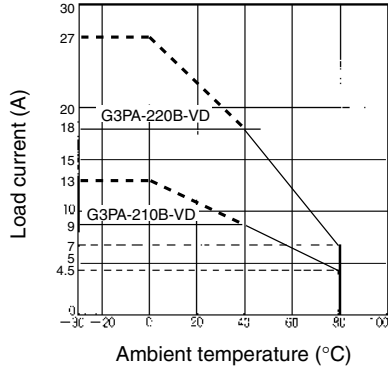

G3PA-240B(L)-VD

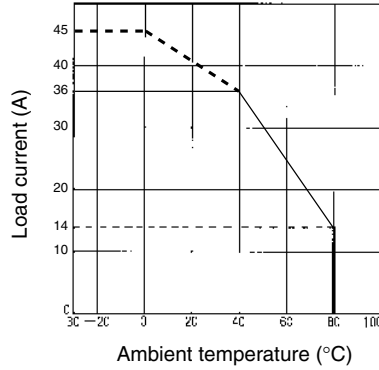

G3PA-260B(L)-VD

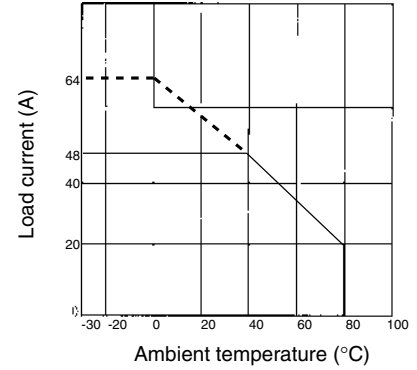

G3PA-420B-VD, G3PA-420B-VD-2

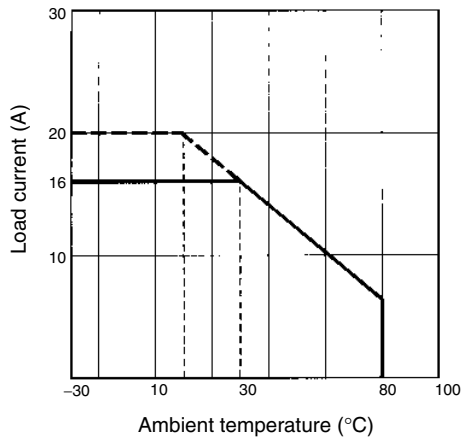

G3PA-430B-VD, G3PA-430B-VD-2

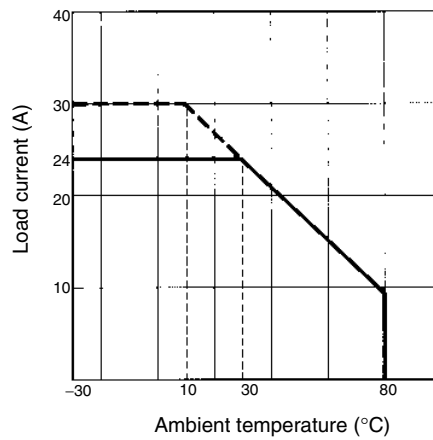

G3PA-450B-VD-2

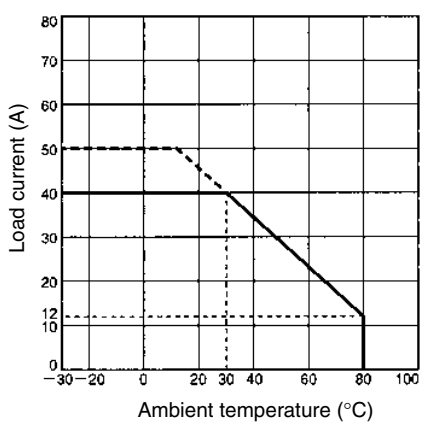

SSR

Inrush Current Resistivity: Non-repetitive

Note: Keep the inrush current to half the rated value if it occurs repetitively.

G3PA-210B(L)-VD

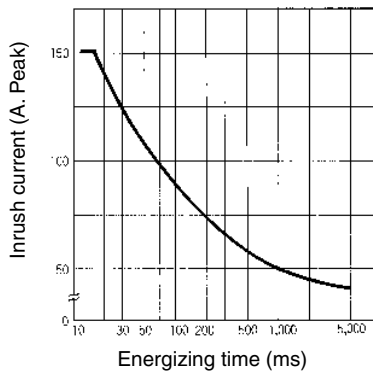

**G3PA-220B(L)-VD, G3PA-420B-VD,
G3PA-420B-VD-2**

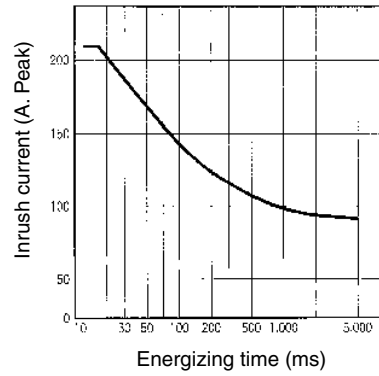

**G3PA-240B(L)-VD/260B(L)-VD,
G3PA-430B-VD, G3PA-430B-VD-2,
G3PA-450B-VD-2**

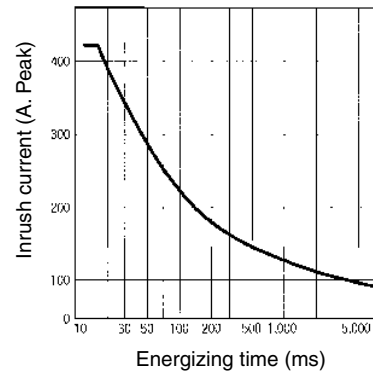

Dimensions

Note: All units are in millimeters unless otherwise indicated.

G3PA-210B(L)-VD

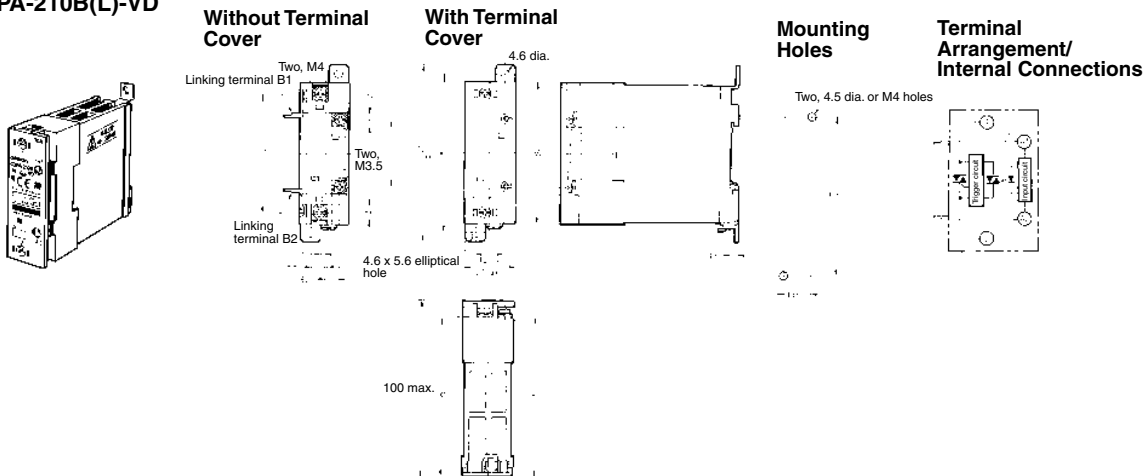

G3PA-220B(L)-VD

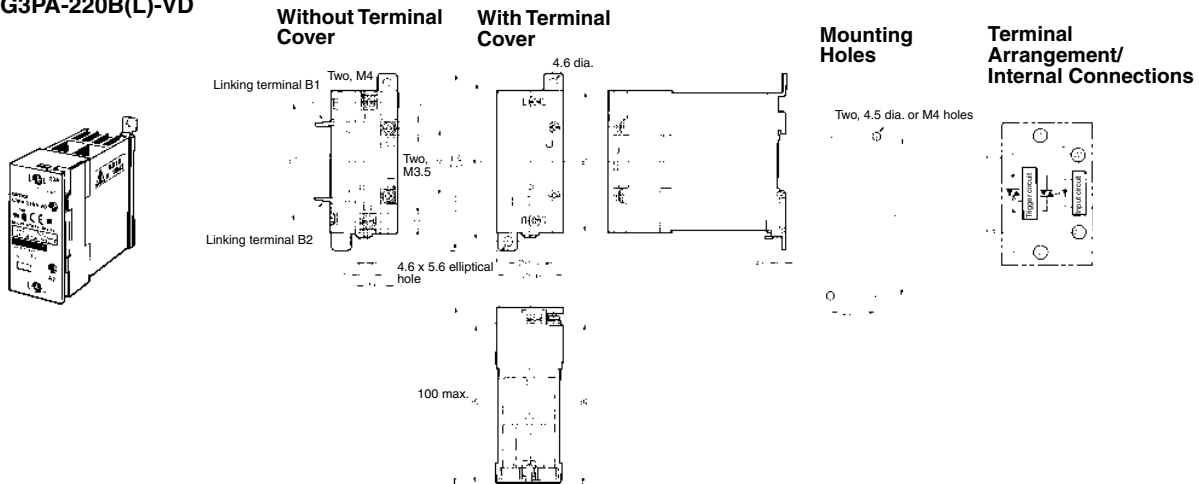

G3PA-240B(L)-VD

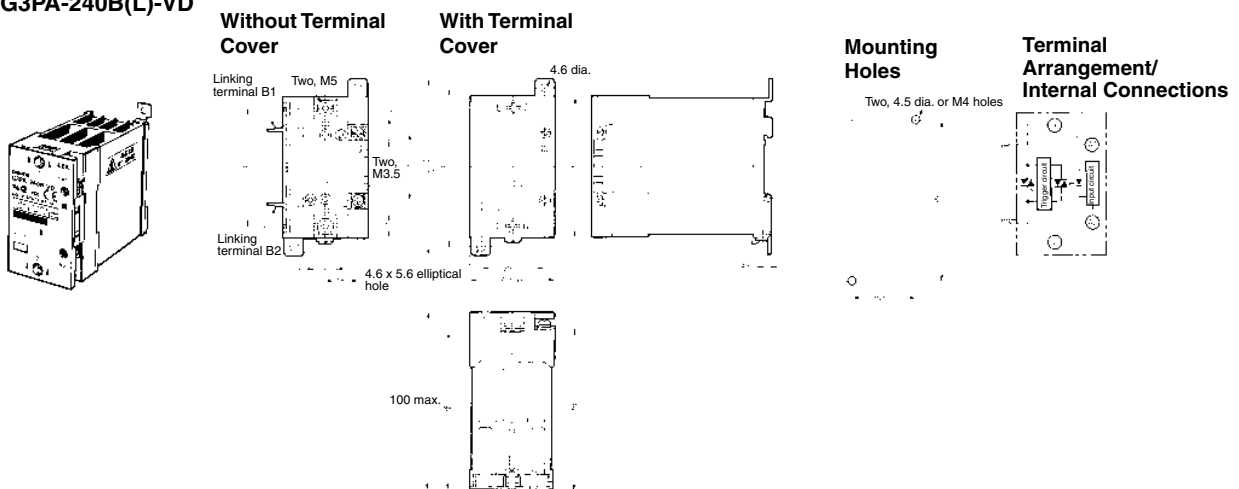

SSR

**G3PA-260B(L)-VD
G3PA-450B-VD-2**

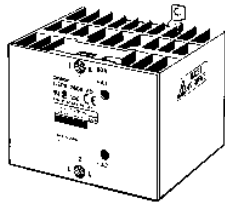

With Terminal Cover

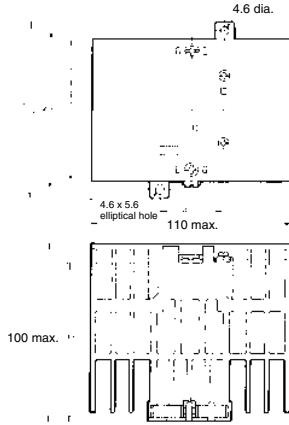

Without Terminal Cover

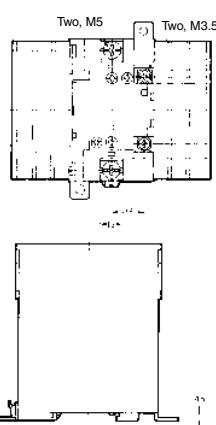

Mounting Holes

Two, 4.5 dia. or M4 holes

**Terminal Arrangement/
Internal Connections**

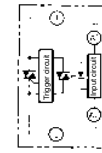

G3PA-420B-VD, G3PA-420B-VD-2

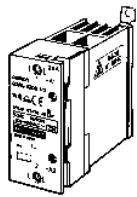

Without Terminal Cover

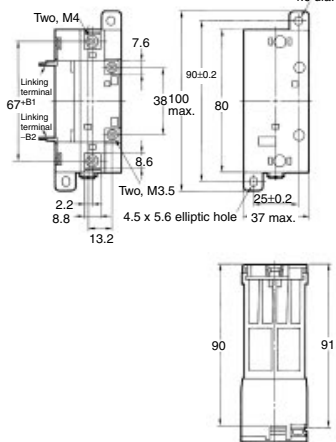

With Terminal Cover

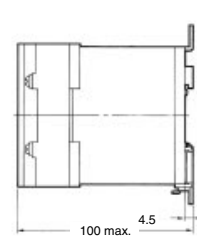

Mounting Holes

Two, 4.5 dia. or M4

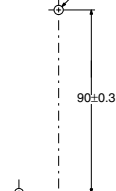

**Terminal Arrangement/
Internal Connections**

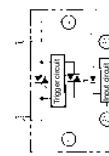

G3PA-430B-VD, G3PA-430B-VD-2

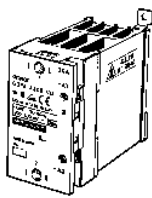

Without Terminal Cover

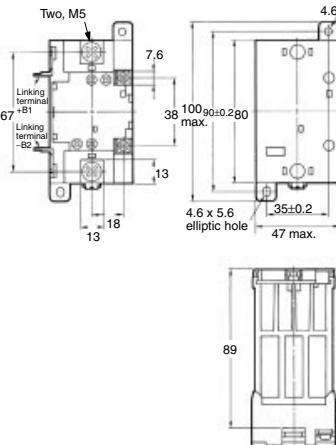

With Terminal Cover

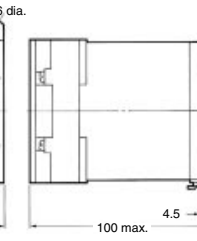

Mounting Holes

Two, 4.5 dia. or M4

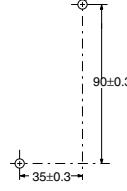

**Terminal Arrangement/
Internal Connections**

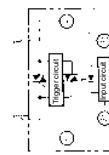

Precautions

Refer to the *Technical Information for SSRs* (Cat. No. J137) for general precautions.

■ Correct Use

Load Connection

For an AC load, use a power supply rated at 50 or 60 Hz. The maximum operating frequency is 10 Hz.

The G3PA-(VD) has a built-in varistor for overvoltage protection.

At a low applied voltage, such as 24 VAC, the load current is not fully supplied. When the Unit is switched ON, the voltage required to power the Unit deprives the output signal of the necessary voltage level and thus creates loss time. The lower the load voltage is, the greater the loss time is. This condition, however, will not create any serious problems.

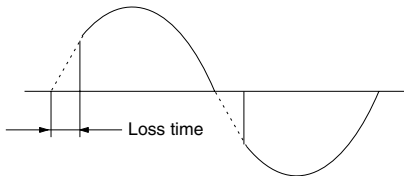

For a DC or L load, a diode should be connected in parallel the load to absorb the counter electromotive force of the load.

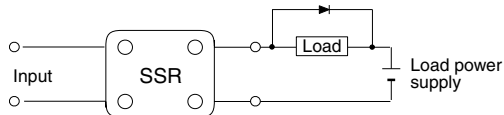

When attaching a heat sink to the G3PA-(VD), in order to facilitate heat dissipation, apply Silicone Grease or equivalent heat conductive grease on the heat sink. (Toshiba Silicon, Shinetsu Silicon, etc.)

Tighten the mounting screws of the heat sink with a torque of 0.78 to 0.98 N·m.

Noise Terminal Voltage according to EN55011

The G3PA-(VD) conforms to EN55011 standards when a capacitor is connected to the load power supply as shown in the following circuit diagram.

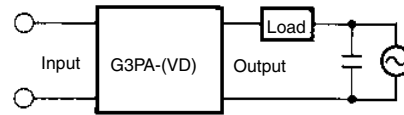

Recommended Capacitor:
NISSEI ELECTRIC Co., LTD, TYPE R40 (MKT Series), 1 μF

ALL DIMENSIONS SHOWN ARE IN MILLIMETERS.
To convert millimeters into inches, multiply by 0.03937. To convert grams into ounces, multiply by 0.03527.

Cat. No. K094-E1-04

In the interest of product improvement, specifications are subject to change without notice.