

AC-DC Switching Power Module

AC60 series

APPLICATION NOTE
Rev A



Content

1. INTRODUCTION	3
2. AC60 SERIES CONVERTER FEATURES	3
3. TECHNICAL SPECIFICATIONS	4
4. MAIN FEATURES AND FUNCTIONS	5
4.1 Operating Temperature Range	5
4.3 Output Protection	5
5. SAFETY	5
6. APPLICATIONS	5
6.1 Power De-Rating Curve	5
6.2 Test Set-Up	6
6.3 Output Ripple and Noise Measurement	6
6.4 Installation Instruction	6
7. AC60 SERIES MECHANICAL OUTLINE DIAGRAMS	7
8. PART NUMBER	8

1. Introduction

This application note describes the features and functions of Intronics AC60 series of open frame, switching AC-DC power module. These are highly efficient, reliable and compact, high power density, single output AC/DC power module. The module is fully protected against short circuit and over-voltage conditions. Intronics world class automated manufacturing methods, together with an extensive testing and qualification program; ensure that the AC60S480 power module is extremely reliable.

2. AC60 series Converter Features

- 60W Isolated Output
- High Efficiency Up to 88%
- Fixed Switching Frequency
- Universal Input Range
- Regulated Output
- Continuous Short Circuit Protection
- 2" X 4" size, low profile
- Open-Frame Type

3. Technical Specifications

(All specifications are typical at nominal input, full load at 25°C unless otherwise noted.)

PARAMETER	NOTES and CONDITIONS	Device	Min.	Typical	Max.	Units
ABSOLUTE MAXIMUM RATINGS						
Input Voltage						
Continuous			90		264	Vac
Operating Temperature			0		+50	°C
Storage Temperature			-20		+85	°C
Input/Output Isolation Voltage	1 minute		4242			Vdc
INPUT CHARACTERISTICS						
Operating Voltage Range			100		240	Vac
Input Frequency Range			47		63	HZ
Maximum Input Current	100% Load, Vin=90Vac			1.4		A
Leakage Current					3.5	mA
Inrush Current	Vin=264Vac, cold start at 25°C.				50	A
OUTPUT CHARACTERISTIC						
Output Voltage Set Point	Vin=Nominal Vin , Io=Io.max, Tc=25°C	AC60S033	3.26	3.3	3.33	Vdc
		AC60S050	4.95	5.0	5.05	
		AC60S090	8.91	9.0	9.09	
		AC60S120	11.88	12.0	12.12	
		AC60S150	14.85	15.0	15.15	
		AC60S240	23.76	24.0	24.24	
		AC60S280	27.72	28.0	28.28	
		AC60S360	35.64	36.0	36.36	
Operating Output Current Range		AC60S033		8		A
		AC60S050		8		
		AC60S090		6.67		
		AC60S120		5		
		AC60S150		4		
		AC60S240		2.5		
		AC60S280		2		
		AC60S360		1.67		
AC60S480		1.25				
Holdup Time	Vin=115Vac			8		mS
Output Voltage Regulation						
Load Regulation	10% load to Full load				±1.0	%
Line Regulation	Vin=high line to low line				±0.5	%
Output voltage Ripple and Noise						
20MHZ bandwidth						
Peak-to-Peak	Full load, 0.1uF ceramic and 10uF E.L capacitor	AC60S033			50	mV
		AC60S050			50	
		AC60S090			90	
		AC60S120			120	
		AC60S150			150	
		AC60S240			240	
		AC60S280			280	
		AC60S360			360	
AC60S480			480			
ISOLATION CHARACTERISTICS						
Input to Output	1 minute				4242	Vdc
Input to Earth	1 minute				2121	Vdc
Output to Earth	1 minute				707	Vdc
Isolation Resistance			100			MΩ
FEATURE CHARACTERISTICS						
Switching Frequency				60		KHZ
GENERAL SPECIFICATIONS						
MTBF	Io=100%of Io.max; Ia=25 °C per MIL-HDBK-217F			TBD		M hours
Weight				0.175		kg

4. Main Features and Functions

4.1 Operating Temperature Range

Intronics AC60 series power modules, which highly efficient design, has resulted in its ability to operate ambient temperature environment (0°C to 50°C). Due to consideration must be given to the de-rating curves when ascertaining maximum power that can be drawn from the power module. The maximum power drawn is influenced by a number of factors, such as:

- Input voltage range.
- Output load current.
- These can be effective heat sinks for the power module.

4.3 Output Protection

The power modules provide a full continuous short-circuit protection. The unit will auto recover once the short circuit is removed. To provide protection in a fault condition, the unit is equipped with internal over-current protection. The unit will operate normally once the fault condition is removed. The power module will go to hiccup mode if the output current or voltage is set from 110% to 150% of rated current or voltage.

5. Safety

- Ⓢ CB Approval
- Ⓢ TUV Approval
- Ⓢ UL Approval
- Ⓢ CE Approval

6. Applications

6.1 Power De-Rating Curve

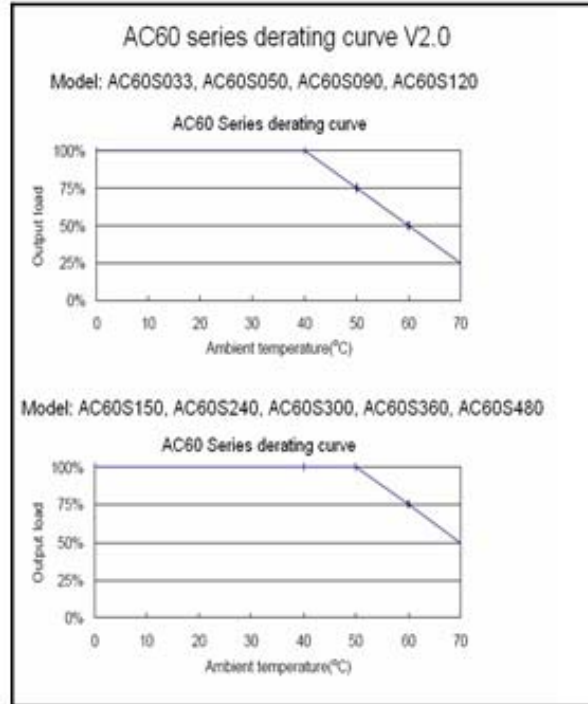

6.2 Test Set-Up

The basic test set-up to measure parameters such as efficiency and load regulation is shown in Figure 1. When testing the Intronics AC60 series under any transient conditions, please ensure that the transient response of the source is sufficient to power the equipment under test. We can calculate the

- Efficiency
- Load regulation and line regulation.

The value of efficiency is defined as:

$$\eta = \frac{V_o \times I_o}{P_{in}} \times 100\%$$

Where: V_o is output voltage,
 I_o is output current,
 P_{in} is input power,

The value of load regulation is defined as:

$$Load\ reg = \frac{V_{FL} - V_{NL}}{V_{NL}} \times 100\%$$

Where V_{FL} is the output voltage at full load
 V_{NL} is the output voltage at 10% load

The value of line regulation is defined as:

$$Line\ reg = \frac{V_{HL} - V_{LL}}{V_{LL}} \times 100\%$$

Where V_{HL} is the output voltage of maximum input voltage at full load.
 V_{LL} is the output voltage of minimum input voltage at full load.

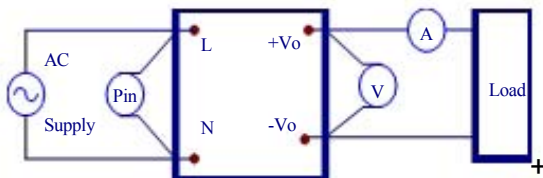
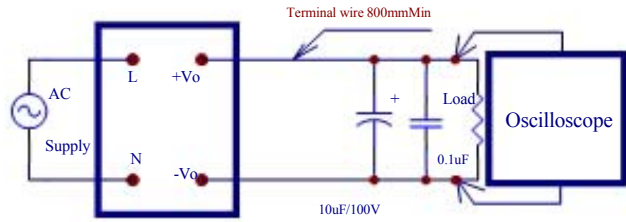

Figure 1. AC60 Series Test Setup

6.3 Output Ripple and Noise Measurement

The test set-up for noise and ripple measurements is shown in Figure 2. Measured method :

Add a 0.1 uF ceramic capacitor and a 10 uF electrolytic capacitor to output at 20 MHz Band Width.



AC60S Series

Figure 2. Output Voltage Ripple and Noise Measurement Set-Up

6.4 Installation Instruction

Please use the mounting hold as:
 AC60 series : 4 holds of ϕ 3.17

And insert the spacer (Max ϕ 6) of height over 8mm to lift the unit . The vibration spec. is the value take when the unit is raised by 8mm spacers.

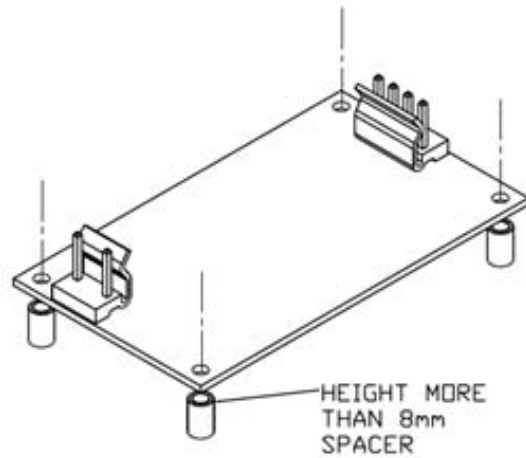

Please reserve 4mm space from the surfaces and the sides of PCB, especially from the solder surface, 8mm space is necessary. If the space is not enough, the specification of insulation and withstand will not be satisfied.

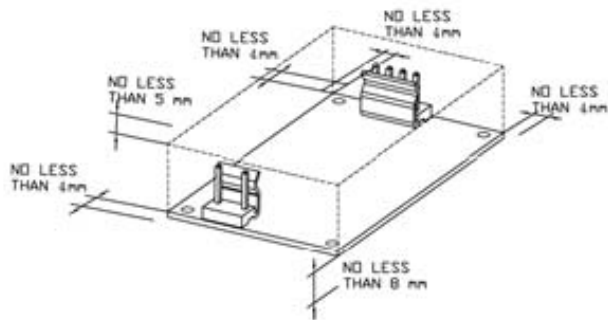

FG should be connected to the earth terminal of the apparatus. If not, the conducted noise and output noise will increase.

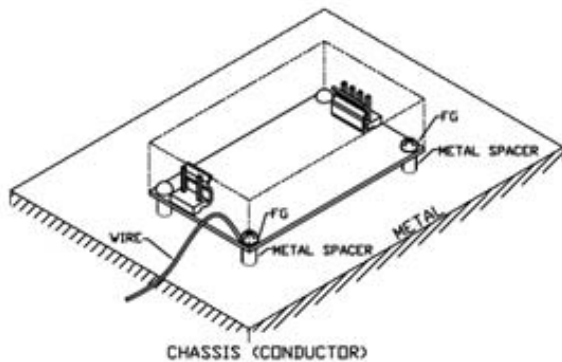

7.AC60 Series Mechanical Outline

Diagrams

Dimensions are in millimeters

Tolerance: $x.x \pm 0.5mm$, unless otherwise noted

Annotations : All models height does not exceed 34mmMAX .

All Dimensions are in Inches[mm]
 Tolerances: $XX \pm 02[XX \pm 5]$ unless otherwise noted

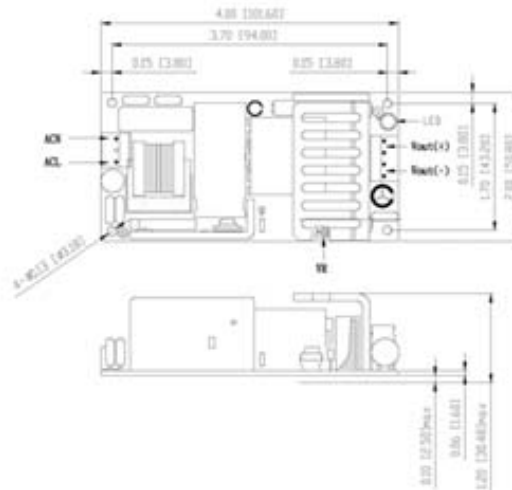

Figure 6. AC60 series Mechanical Outline Diagram

8. Part Number

