

HIGH POWERED MULTI-LINE TVS ARRAY

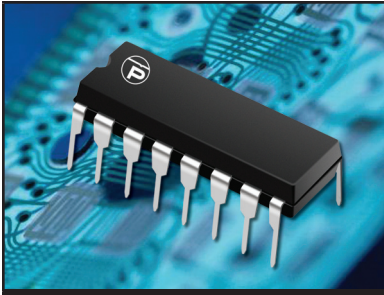

16 PIN DIP PACKAGE

DESCRIPTION

The LCA Series are high powered multi-line TVS arrays available in a 16 pin DIP package. This series is designed to protect high-speed applications from the damaging effects of ESD, EFT and secondary transient threats.

The LCA Series has a peak pulse power rating of 800 Watts for an 8/20 μ s waveshape. This devices meets the IEC 61000-4-2, IEC 61000-4-4 and IEC 61000-4-5 requirements.

FEATURES

- Compatible with IEC 61000-4-2 (ESD): Air - 15kV, Contact - 8kV
- Compatible with IEC 61000-4-4 (EFT): 40A - 5/50ns
- Compatible with IEC 61000-4-5 (Surge): 24A, 8/20 μ s - Level 2(Line-Gnd) & Level 3(Line-Line)
- 800 Watts Peak Pulse Power per Line (tp = 8/20 μ s)
- Bidirectional Configuration
- ESD Protection > 25 kilovolts
- Available in Multiple Voltages
- Protects up to 6 Lines
- Low Capacitance: 15pF
- RoHS Compliant
- REACH Compliant

APPLICATIONS

- Ethernet 10/100 Base T
- RS-485
- xDSL & ATM
- SCSI & USB Interfaces
- Audio/Video I/O Ports

MECHANICAL CHARACTERISTICS

- Molded 16 Pin Dual-In-Line (DIP) Package
- Approximate Weight: 1.2 grams
- Lead-Free Pure-Tin Plating (Annealed)
- Solder Reflow Temperature:
Pure-Tin - Sn, 100: 260-270°C
- Flammability Rating UL 94V-0

PIN CONFIGURATION

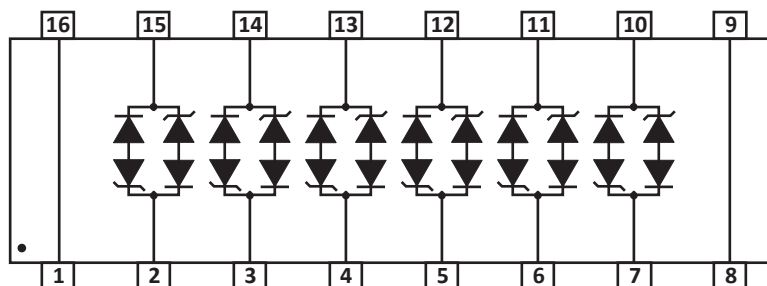

TYPICAL DEVICE CHARACTERISTICS
MAXIMUM RATINGS @ 25°C Unless Otherwise Specified

PARAMETER	SYMBOL	VALUE	UNITS
Peak Pulse Power (tp = 8/20μs) - See Figure 1	P_{PP}	800	Watts
Operating Temperature	T_L	-55 to 150	°C
Storage Temperature	T_{STG}	-55 to 150	°C

ELECTRICAL CHARACTERISTICS PER LINE @ 25°C Unless Otherwise Specified

PART NUMBER (Note 1)	RATED STAND-OFF VOLTAGE V_{WM} VOLTS	MINIMUM BREAKDOWN VOLTAGE @1mA $V_{(BR)}$ VOLTS	MAXIMUM CLAMPING VOLTAGE (Fig. 2) @ IP = 1A V_C VOLTS	MAXIMUM CLAMPING VOLTAGE (Fig. 2) @ 8/20μs $V_C @ I_{PP}$	MAXIMUM LEAKAGE CURRENT @ V_{WM} I_D μA	MAXIMUM CAPACITANCE @0V, 1MHz C pF	TEMPERATURE COEFFICIENT OF $V_{(BR)}$ $q V_{(BR)}$ mV/°C
LCA05C	5.0	6.0	9.8	24.0V @ 45.0A	100	15	3
LCA08C	8.0	8.5	12.3	25.5V @ 40.0A	10	15	9
LCA12C	12.0	13.3	19.0	32.0V @ 34.0A	4	15	16
LCA15C	15.0	16.7	25.5	38.0V @ 27.0A	4	15	17
LCA24C	24.0	26.7	40.0	48.0V @ 22.0A	4	15	26

NOTES

1. Tested on pin pairs 1 and 16, 2 and 15, 3 and 14, 4 and 13, 5 and 12, 6 and 11, 7 and 10, 8 and 9.

TYPICAL DEVICE CHARACTERISTICS

FIGURE 1
PEAK PULSE POWER VS PULSE TIME

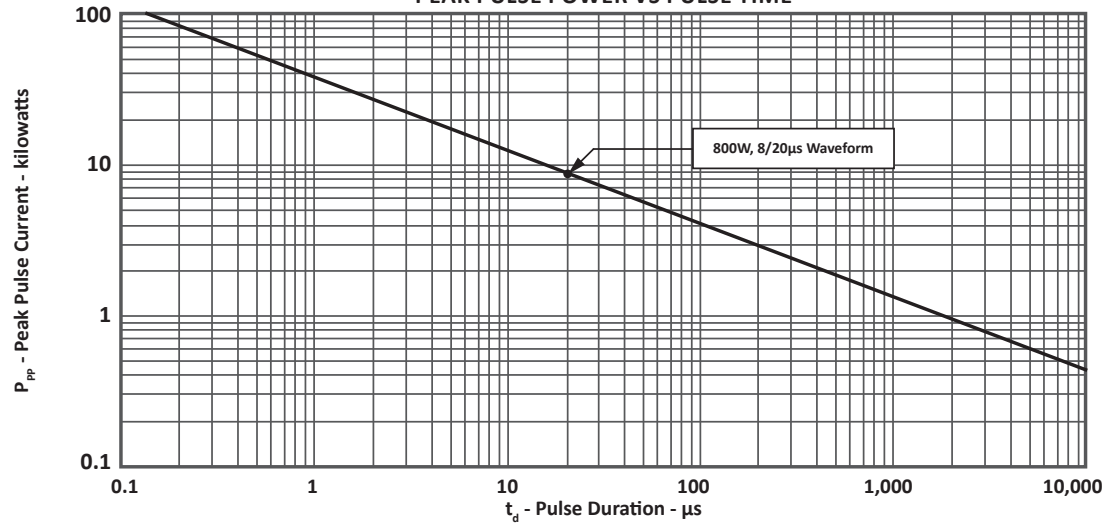

FIGURE 2
PULSE WAVE FORM

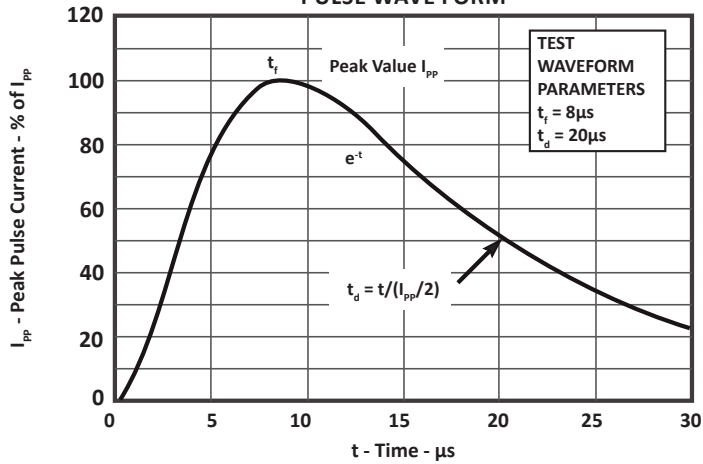
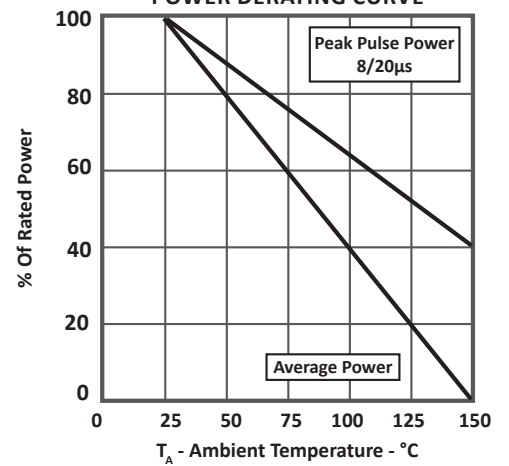
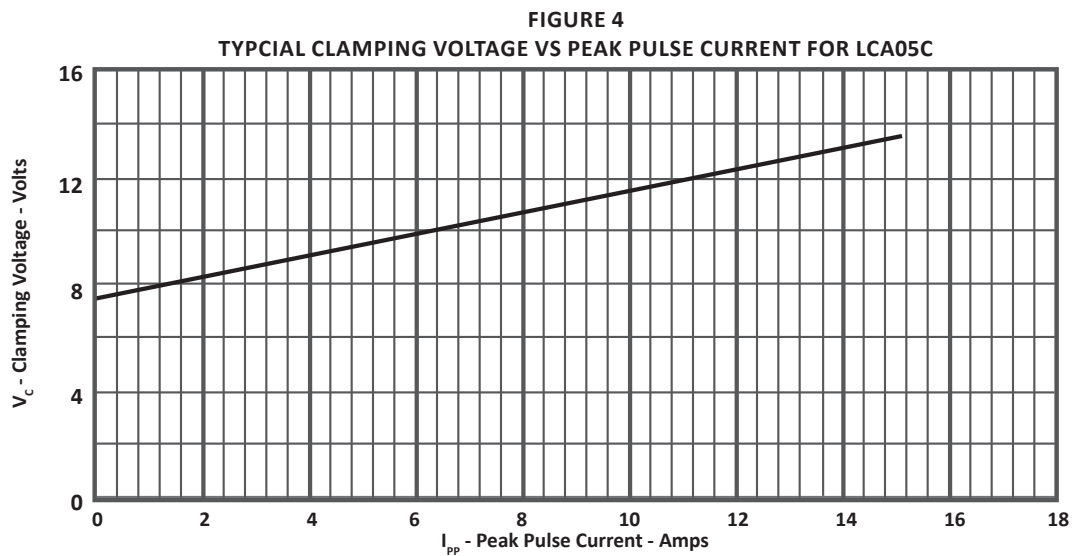
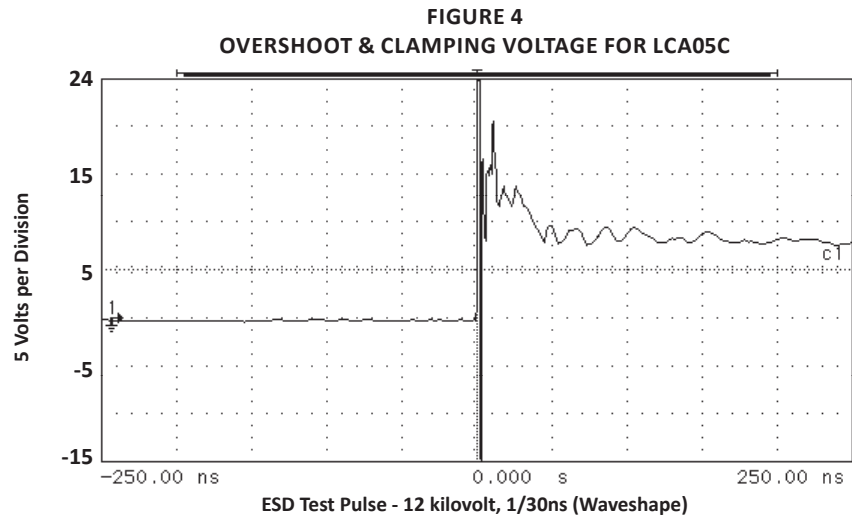

FIGURE 3
POWER DERATING CURVE



TYPICAL DEVICE CHARACTERISTICS



SPICE MODEL

FIGURE 1
SPICE MODEL

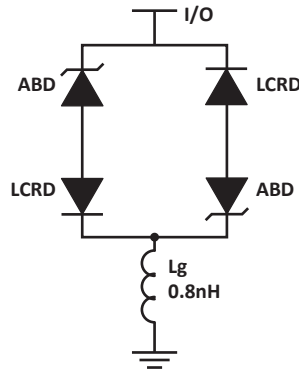

ABD - Avalanche Breakdown Diode (TVS)
 LCRD: Low Capacitance Rectifier Diode
 Lg - Lead Inductance

TABLE 1 - SPICE PARAMETERS

PARAMETER	UNIT	ABD(TVS)	LCRD
BV	V	See Table 2	200
IBV	μ A	1	0.01
C_{jo}	pF	See Table 2	5
I_s	A	See Table 2	1E-13
Vj	V	0.6	0.6
M	-	0.33	0.33
N	-	1	1
R_s	Ohms	See Table 2	0.31
TT	s	1E-8	1E-9
EG	eV	1.11	1.11

TABLE 2 - ABD SPECIFIC SPICE PARAMETERS

PART NUMBER	B_v (VOLTS)	C_{jo} (pF)	I_s (AMPS)	R_s (OHMS)
LCA05C	6.0	893	1E-11	0.09
LCA08C	8.5	481	1E-13	0.18
LCA12C	13.3	319	1E-13	0.22
LCA15C	16.7	238	1E-13	0.31
LCA24C	26.7	210	1E-13	0.93

16 PIN DIP PACKAGE INFORMATION

OUTLINE DIMENSIONS

DIM	MILLIMETERS		INCHES	
	MIN	MAX	MIN	MAX
A	18.80	19.55	0.740	0.770
B	6.35	6.85	0.250	0.270
C	7.50	7.74	0.295	0.305
D	0.21	0.38	0.008	0.015
E	0°	10°	0°	10°
F	0.51	1.01	0.020	0.040
G	3.69	4.44	0.145	0.175
H	2.80	3.30	0.110	0.130
I	1.02	1.77	0.040	0.070
J	1.27	1.27	0.050	0.050
K	0.39	0.53	0.015	0.021
L	2.54	2.54	0.100	0.100

NOTES

- Dimensions are exclusive of mold flash and metal burrs.
- Dimensions "J" and "L" are between centers.

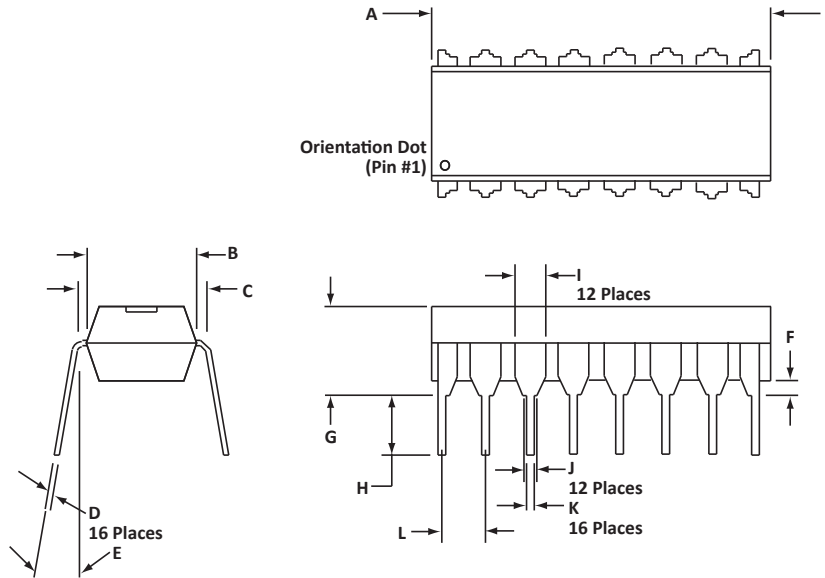

ORDERING INFORMATION

BASE PART NUMBER (xx = Voltage)	LEADFREE SUFFIX	TAPE SUFFIX	QTY/REEL	REEL SIZE	TUBE QTY
LCAxxC	-LF	n/a	n/a	n/a	25

NOTES

- Marking on Part - logo, part number, date code and pin one defined by dot on top of package.

Package outline per document number 06003.R2 9/09.

COMPANY INFORMATION

COMPANY PROFILE

ProTek Devices, based in Tempe, Arizona USA, is a manufacturer of Transient Voltage Suppression (TVS) products designed specifically for the protection of electronic systems from the effects of lightning, Electrostatic Discharge (ESD), Nuclear Electromagnetic Pulse (NEMP), inductive switching and EMI/RFI. With over 25 years of engineering and manufacturing experience, ProTek designs TVS devices that provide application specific protection solutions for all electronic equipment/systems.

ProTek Devices Analog Products Division, also manufactures analog interface, control, RF and power management products.

CONTACT US

Corporate Headquarters

2929 South Fair Lane
Tempe, Arizona 85282
USA

By Telephone

General: 602-431-8101
Sales: 602-414-5109
Customer Service: 602-414-5114

By Fax

General: 602-431-2288

By E-mail:

Sales: sales@protekdevices.com
Customer Service: service@protekdevices.com
Technical Support: support@protekdevices.com

Web

www.protekdevices.com
www.protekanalog.com

COPYRIGHT © ProTek Devices 1998 - This literature is subject to all applicable copyright laws and is not for resale in any manner.

SPECIFICATIONS: ProTek reserves the right to change the electrical and or mechanical characteristics described herein without notice.

DESIGN CHANGES: ProTek reserves the right to discontinue product lines without notice and that the final judgement concerning selection and specifications is the buyer's and that in furnishing engineering and technical assistance. ProTek assumes no responsibility with respect to the selection or specifications of such products. ProTek makes no warranty, representation or guarantee regarding the suitability of its products for any particular purpose, nor does ProTek assume any liability arising out of the application or use of any product or circuit and specifically disclaims any and all liability without limitation special, consequential or incidental damages.

LIFE SUPPORT POLICY: ProTek Devices products are not authorized for use in life support systems without written consent from the factory.